

FRAMEWALL

Divide and conquer

LOFTWALL



FrameWall is the new modern room divider screen system designed with aesthetics and privacy in mind for a wide range of spaces

52" WIDE

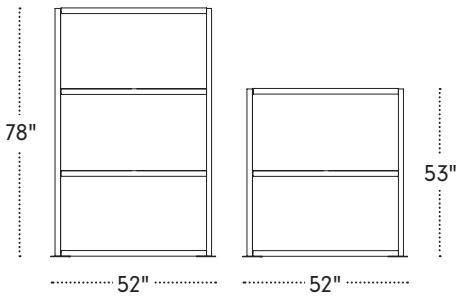

LW 41

LW 42

LW 43

LW 44

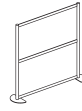
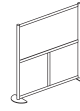
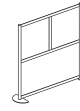
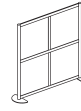
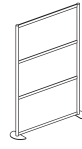
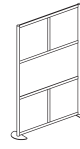
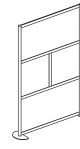
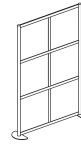

76" WIDE

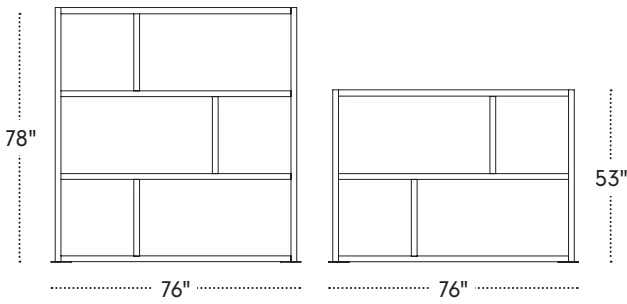

LW 61

LW 62

LW 63

LW 64

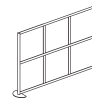
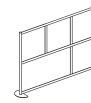
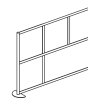
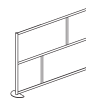
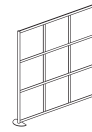
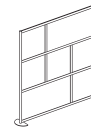
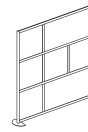
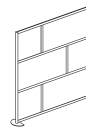

100" WIDE

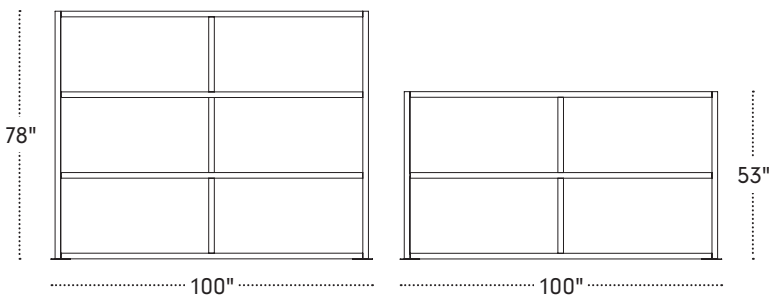

LW 81

LW 82

LW 83

LW 84

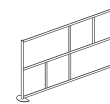
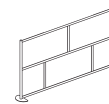
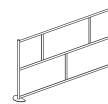
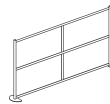
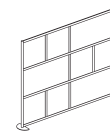
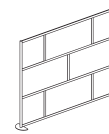
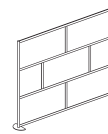
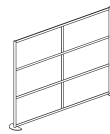

THE OTHER STUFF

Dimensions

- Height: 53" or 78"
- Width: 52", 76", or 100" (base to base)
- Depth: Wall 1.75" | Base 13"

Design Features

- Freestanding movable wall design
- Aluminum interlocking modular frame
- Translucent and opaque panel options
- Connect multiple walls with Link
- Removable panel design
- Integration of third party materials
- Floor or caster base
- Frame finishes: anodized silver, white, black and custom
- Custom sizes and options available

Environmental Features

- Frame made from up to 75% recycled content
- Frame and panels can be recycled
- Panel options meet indoor air quality standards
- VOC free anodized frame finish





PEOPLE DESERVE PRIVACY

The open office provides limitless potential. Potential for collaboration, and even more potential for distraction. That's why companies across the world use Framewall to define their spaces and give their teams a chance to focus and do their best work.