

# Material finishes

Variety is the spice of life

LOFTWALL



# Product contents



**BUFFER** 6  
*room divider*



**CHISEL** 8  
*room divider*



**FLOX** 11  
*room divider*



**FRAMEWALL** 12  
*room divider*



**SHIFT** 16  
*room divider*



**SPLIT** 19  
*room divider*



**WAVE** 22  
*room divider*

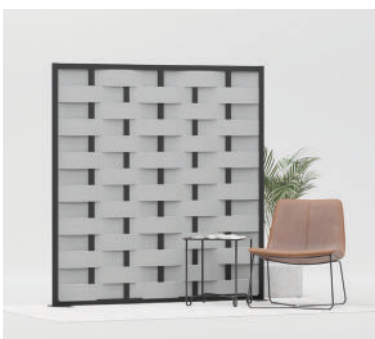

**WEAVE** 24  
*room divider*



**WEB** 26  
*room divider*



**COUNTER SHIELD 28**  
*desk divider*



**DESK SHIELD 30**  
*desk divider*



**HIDE 32**  
*desk divider*



**HITCH 34**  
*desk divider*



**PARALLEL 37**  
*desk divider*



**SHELTER 39**  
*desk divider*



**ARBOR 41**  
*wallcovering*



**TANGO 42**  
*wallcovering*



**TEMPO WALL 44**  
*wallcovering*

# Product contents



**GLIDE** 47  
*architectural*



**HOVER** 50  
*desk divider*



**PIVOT** 52  
*desk divider*

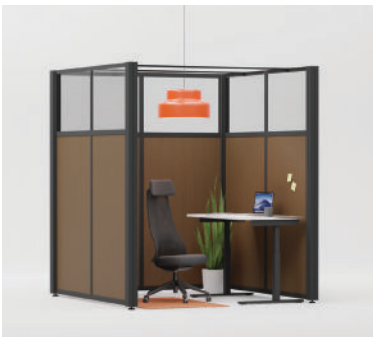

**ROOMS** 56  
*desk divider*



**GRAVITY** 59  
*wallcovering*



**LAYER** 62  
*wallcovering*

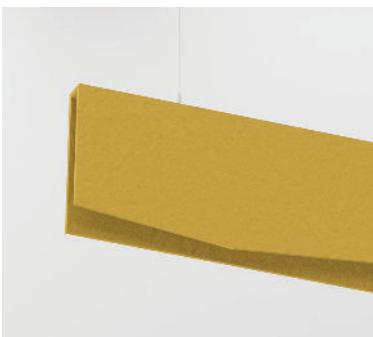

**POCKET** 64  
*wallcovering*



**SKY** 66  
*acoustic baffle*



**TEMPO** 69  
*acoustic baffle*



**THICK**  
*acoustic baffle*

**72**



**THIN**  
*acoustic baffle*

**74**

**OUR PRODUCTS AND MATERIALS ARE SPECIFICALLY DESIGNED & SELECTED TO PROVIDE OUR CLIENTS WITH AS MANY OPTIONS TO CREATE A SPACE THAT MEETS THEIR NEEDS. FOR THE MOST UP TO DATE INFORMATION ON OUR MATERIAL FINISHES, VISIT [LOFTWALL.COM/FINISHES](https://loftwall.com/finishes)**



# Buffer room divider

minimalistic partition for maximum privacy

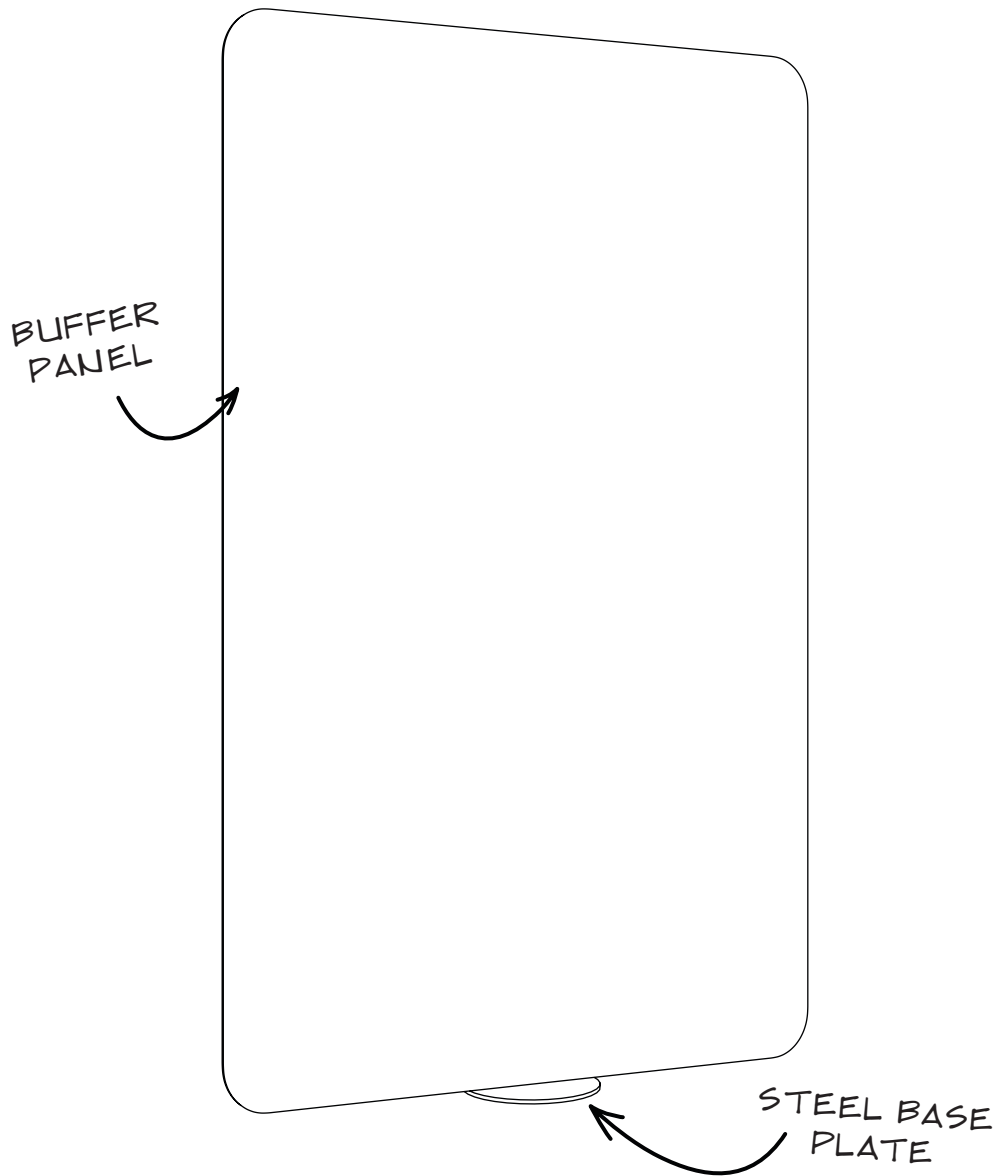

\*AVAILABLE IN THREE HEIGHTS AND THREE WIDTHS

## Steel Base Plate Finishes



Red



Orange



Yellow



Green



Slate Blue



Dark Blue

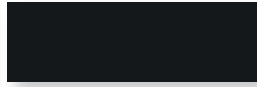

Black



Silver

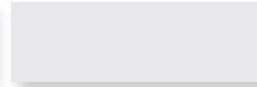

White

## Buffer Panel Finishes

### ACOUSTIC PET



Brick



Pumpkin Spice

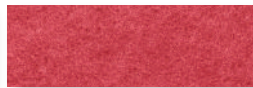

Cherry



Carrot



Sunflower



Straw

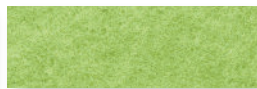

Lime



Guac



Ice

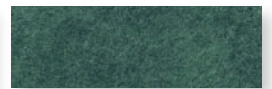

Seafoam

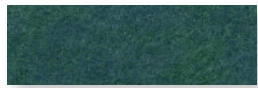

Peacock



Sapphire



Cobalt



Midnight



Grape



Bark



Concrete



Sand

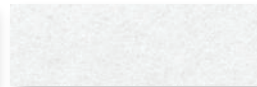

Snow



Pewter



Marble



Steel



Charcoal



Raven

# Chisel room divider

decrease the noise, increase the design

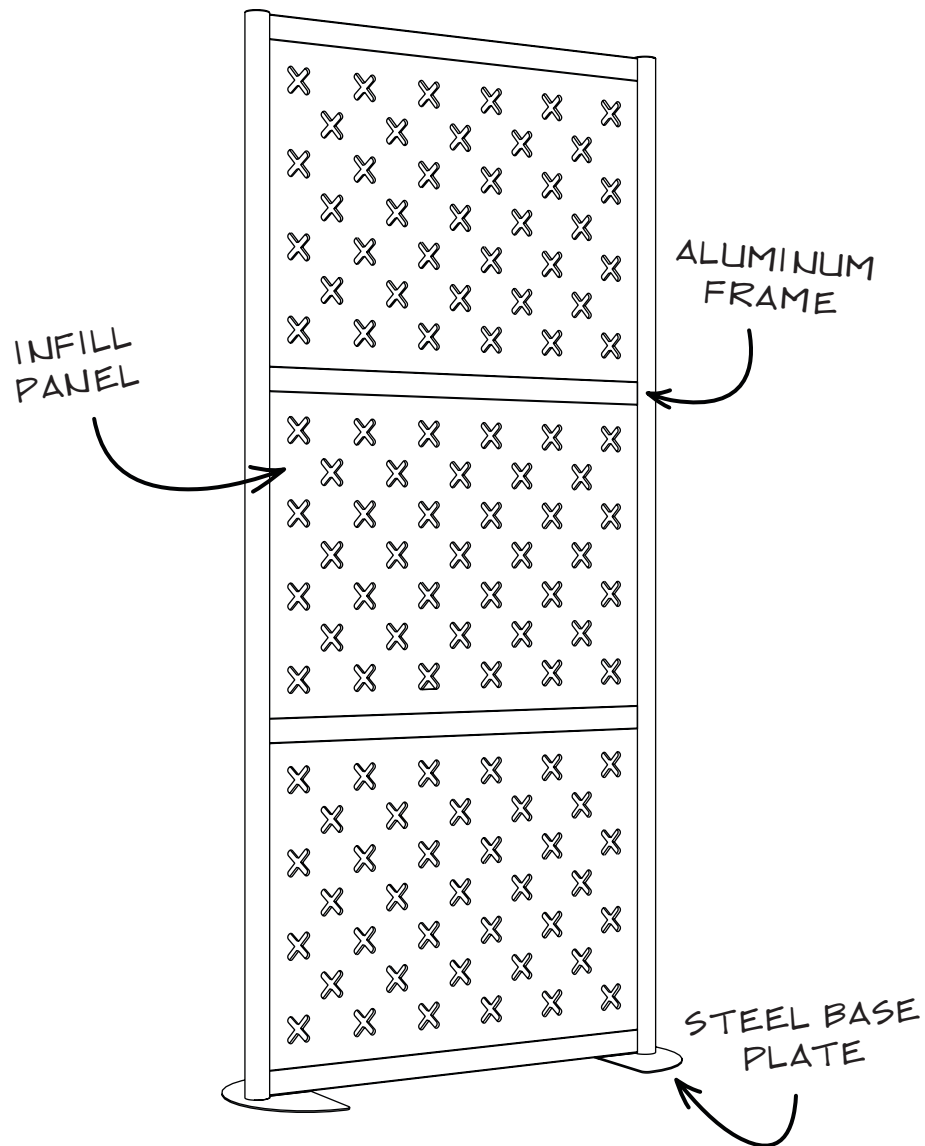

\*AVAILABLE IN TWO HEIGHTS, FIVE WIDTHS  
€ A VARIETY OF DESIGN STYLES



## Aluminum Frame Finishes



Anodized Aluminum

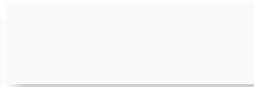

Glossy White



Matte Black

## Steel Base Plate Finishes



Silver



Glossy White



Matte Black

## Infill Panel Finishes

### ACOUSTIC PET



Brick



Pumpkin Spice



Cherry



Carrot



Sunflower



Straw



Lime



Guac



Ice



Seafoam



Peacock



Sapphire



Cobalt



Midnight



Grape



Bark



Concrete



Sand

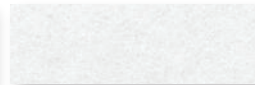

Snow



Pewter



Marble



Steel



Charcoal



Raven

## Cut Design Patterns

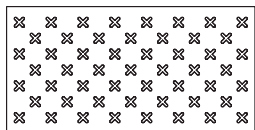

Multiply

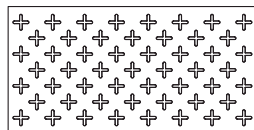

Plus

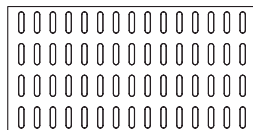

Pills

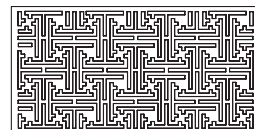

Maze

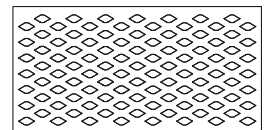

Grate

# Cut Design Patterns

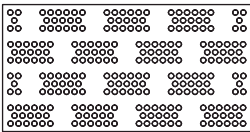

Brick

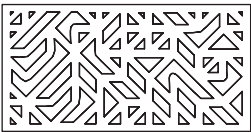

Transit

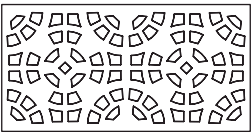

Aztec

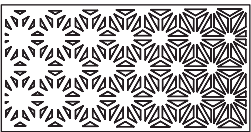

Kaleidoscope

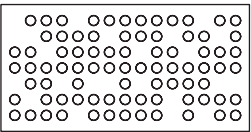

Circles

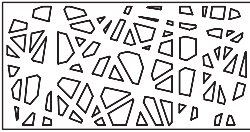

Web

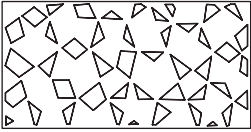

Fractal

\*Chisel panels are only available in 2' x 2', 2' x 3' and 2' x 4'

# Flox room divider

for when you need flexible sound control

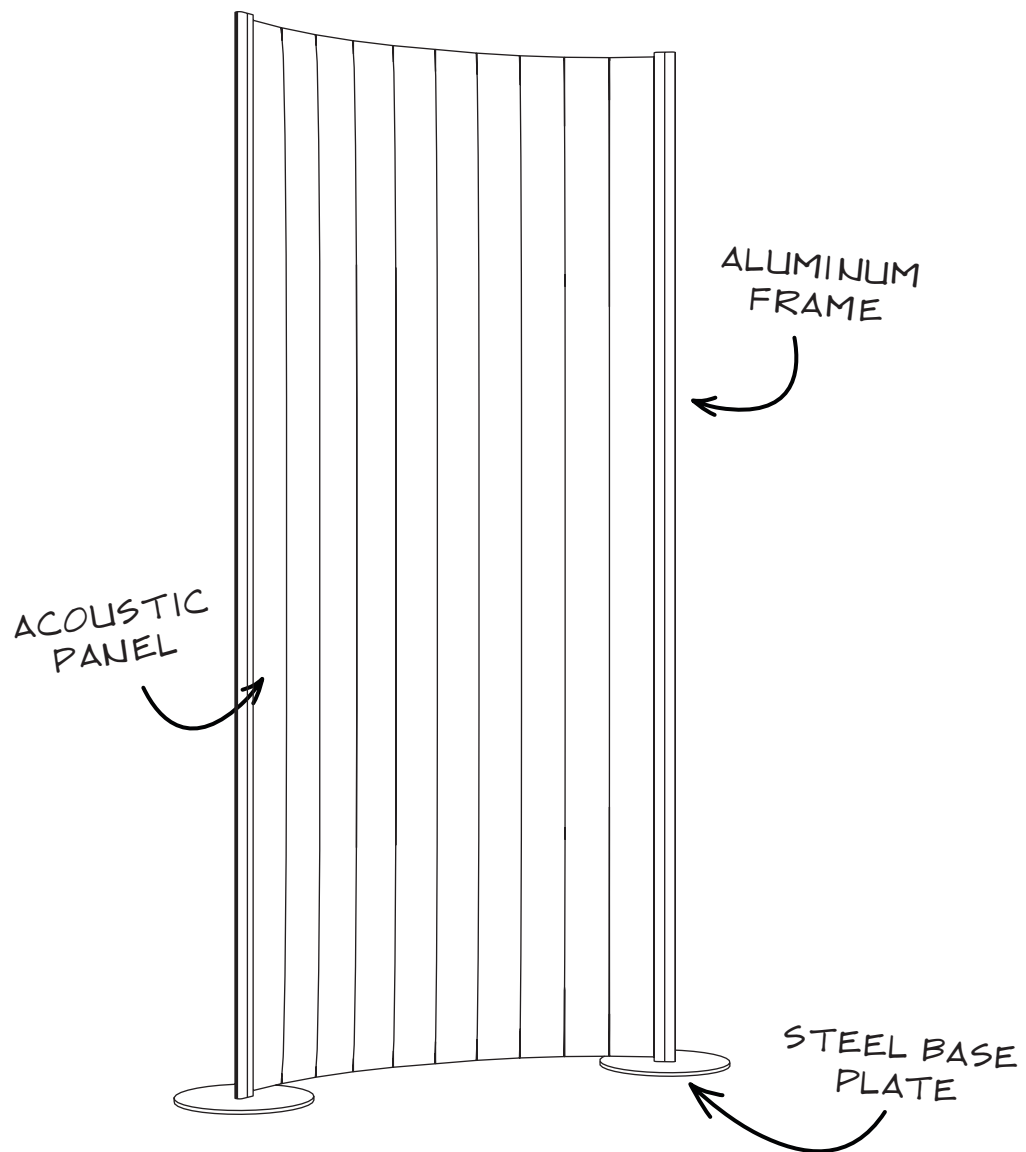

\*AVAILABLE IN ONLY ONE HEIGHT AND ONE WIDTH  
BUT CAN BE LINKED WITH OTHER FLOX

# Aluminum Frame Finishes



Anodized Aluminum

Glossy White

Matte Black

# Steel Base Plate Finishes



Anodized Aluminum

Glossy White

Matte Black

# Acoustic Panel Finishes

## FLOX



Feather

Linen

Slate

Fossil

Moss

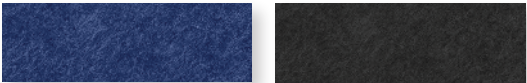

Marine

Coal

# Framework room divider

for when you need to divide and conquer

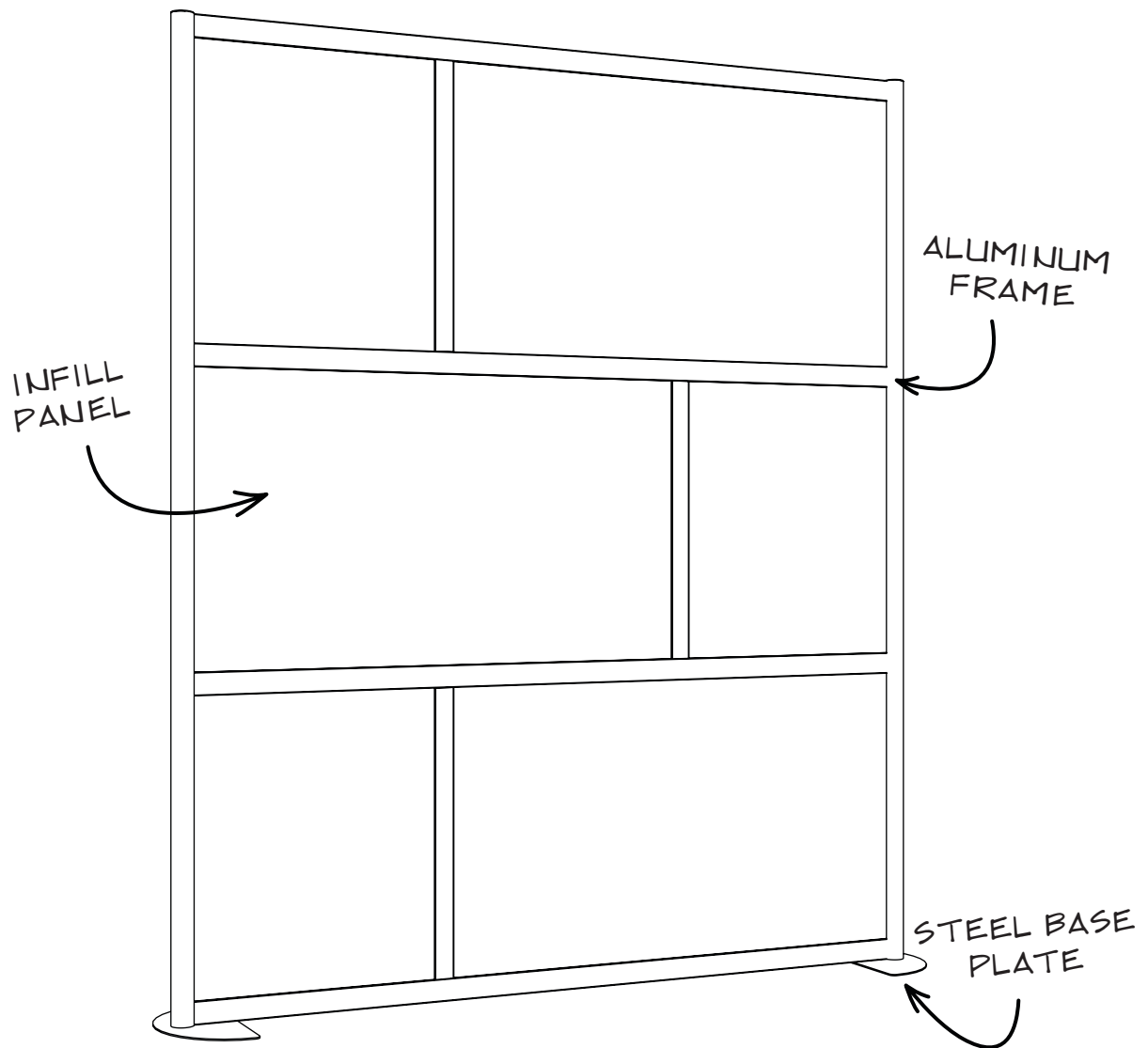

\*AVAILABLE IN TWO HEIGHTS, FIVE WIDTHS  
& A VARIETY OF DESIGN STYLES

## Aluminum Frame Finishes



Anodized Aluminum

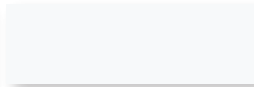

Glossy White



Matte Black

## Steel Base Plate Finishes



Anodized Aluminum



Glossy White



Matte Black

## Infill Panel Finishes

### LAMINATE



Maroon



Teal



Navy



Slate Blue



Gray

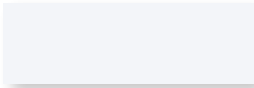

White

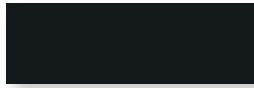

Black

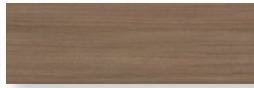

Walnut

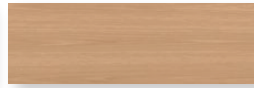

Oak



Elm

### BLOX



Tomato Red



Electric Green



Emerald Green



Spruce Blue



True Blue



Navy



Charcoal



Medium Gray

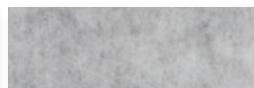

Light Gray



Almost White

\*Blox is made of premium polyester fibers\*\* Only available in 2' x 2' and 2' x 4' panels

### ACOUSTIC PET



Brick



Pumpkin Spice



Cherry



Carrot



Sunflower



Straw



Lime



Guac



Ice



Seafoam

# Infill Panel Finishes

## ACOUSTIC PET (CONTINUED)

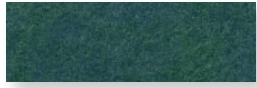

Peacock



Sapphire

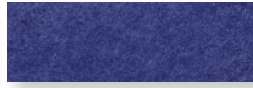

Cobalt



Midnight



Grape



Bark



Concrete



Sand

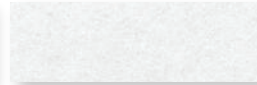

Snow



Pewter



Marble



Steel



Charcoal



Raven

## WRITABLE

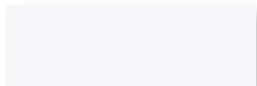

Non-magnetic Dry Erase

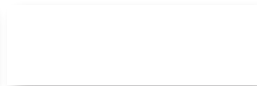

Magnetic Dry Erase

## TRANSLUCENT

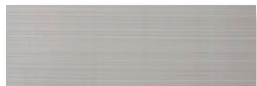

Twinwall Clear

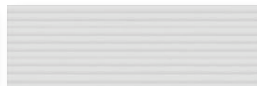

Twinwall White

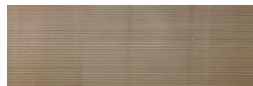

Twinwall Smoke



Frosted Acrylic

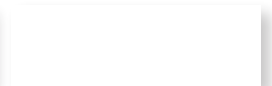

Clear Acrylic

## SPECIALTY PANEL FINISHES



Pegboard



COM Textile



Custom Logo

# Shift room divider

modern shelving where privacy meets storage

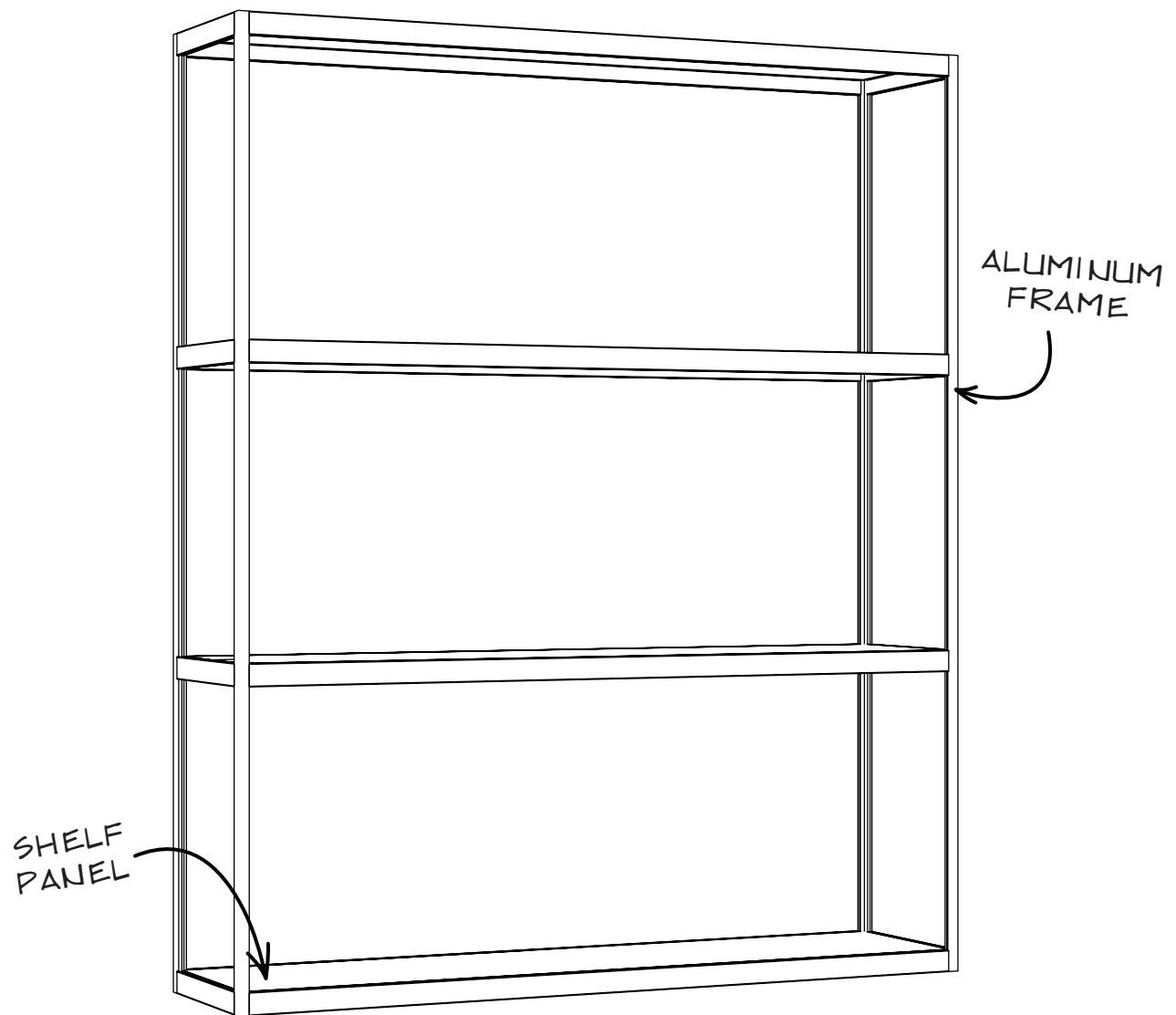

\*AVAILABLE IN TWO HEIGHTS, TWO WIDTHS  
& A VARIETY OF PANEL CONFIGURATIONS



## Aluminum Frame Finishes



Anodized Aluminum

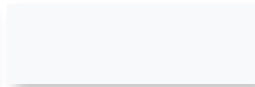

Glossy White



Matte Black

## Shelf Finishes

### LAMINATE



Walnut



Oak



Elm

## Infill Panel Finishes

### LAMINATE



Maroon



Teal



Navy



Slate Blue



Gray

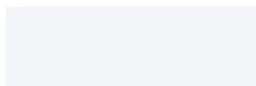

White



Black



Walnut



Oak



Elm

### BLOX



Tomato Red



Electric Green



Emerald Green



Spruce Blue



True Blue

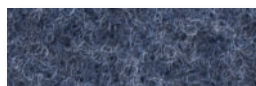

Navy



Charcoal



Medium Gray



Light Gray



Almost White

\*Blox is made of premium polyester fibers\*\* Only available in 2' x 2' and 2' x 4' panels

### ACOUSTIC PET



Brick



Pumpkin Spice



Cherry



Carrot



Sunflower



Straw



Lime



Guac



Ice

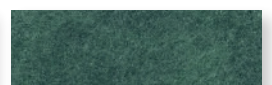

Seafoam

# Infill Panel Finishes

## ACOUSTIC PET (CONTINUED)

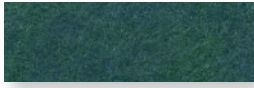

Peacock



Sapphire

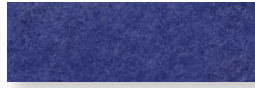

Cobalt



Midnight

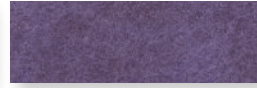

Grape



Bark

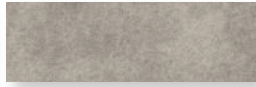

Concrete

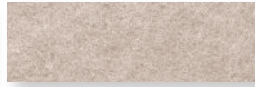

Sand

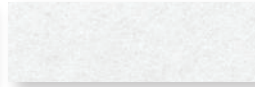

Snow



Pewter



Marble



Steel



Charcoal

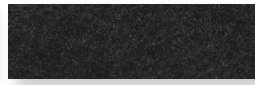

Raven

## TRANSLUCENT



Twinwall Clear

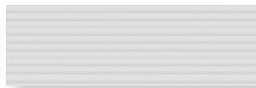

Twinwall White

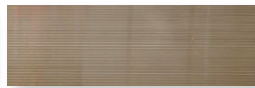

Twinwall Smoke



Frosted Acrylic

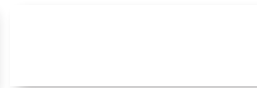

Clear Acrylic

## SPECIALTY PANEL FINISHES

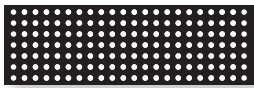

Pegboard



COM Textile



Custom Logo

# Split room divider

light on hardware, heavy on design

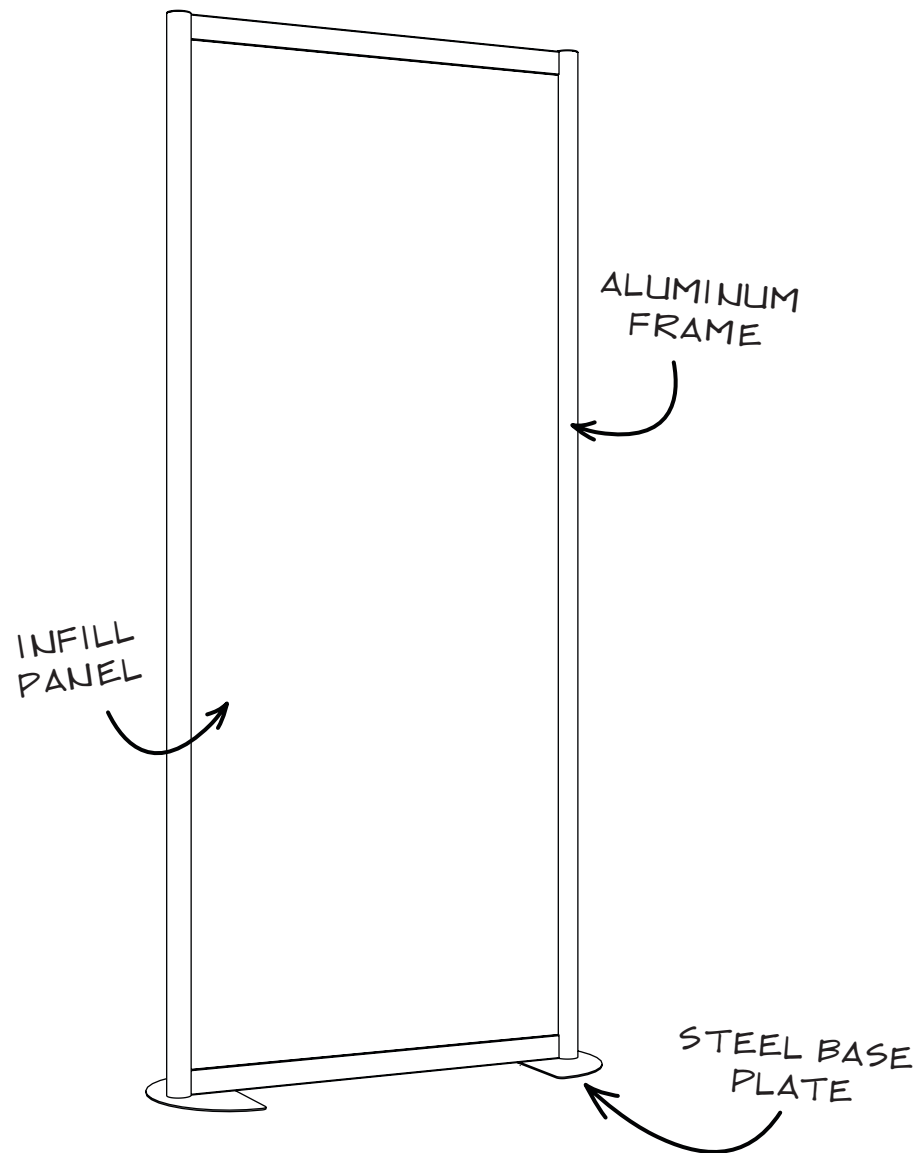

\*AVAILABLE IN TWO HEIGHTS AND FOUR WIDTHS

## Aluminum Frame Finishes



Anodized Aluminum

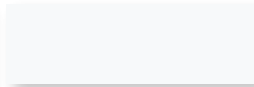

Glossy White



Matte Black

## Steel Base Plate Finishes



Anodized Aluminum



Glossy White



Matte Black

## Infill Panel Finishes

### LAMINATE



Maroon



Teal



Navy



Slate Blue



Gray

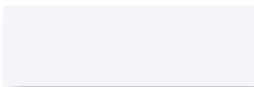

White



Black



Walnut



Oak



Elm

### ACOUSTIC PET



Brick



Pumpkin Spice



Cherry



Carrot



Sunflower



Straw



Lime



Guac



Ice

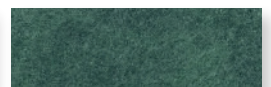

Seafoam



Peacock



Sapphire



Cobalt



Midnight



Grape



Bark



Concrete



Sand



Snow



Pewter



Marble



Steel



Charcoal



Raven

# Infill Panel Finishes

## WRITABLE

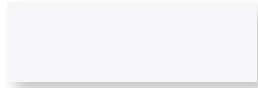

Non-magnetic Dry Erase



Magnetic Dry Erase

## TRANSLUCENT



Twinwall Clear

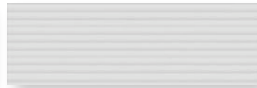

Twinwall White

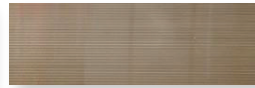

Twinwall Smoke



Frosted Acrylic

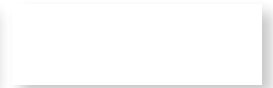

Clear Acrylic

## SPECIALTY PANEL FINISHES



Custom Logo

# Wave room divider

divide a space + add texture

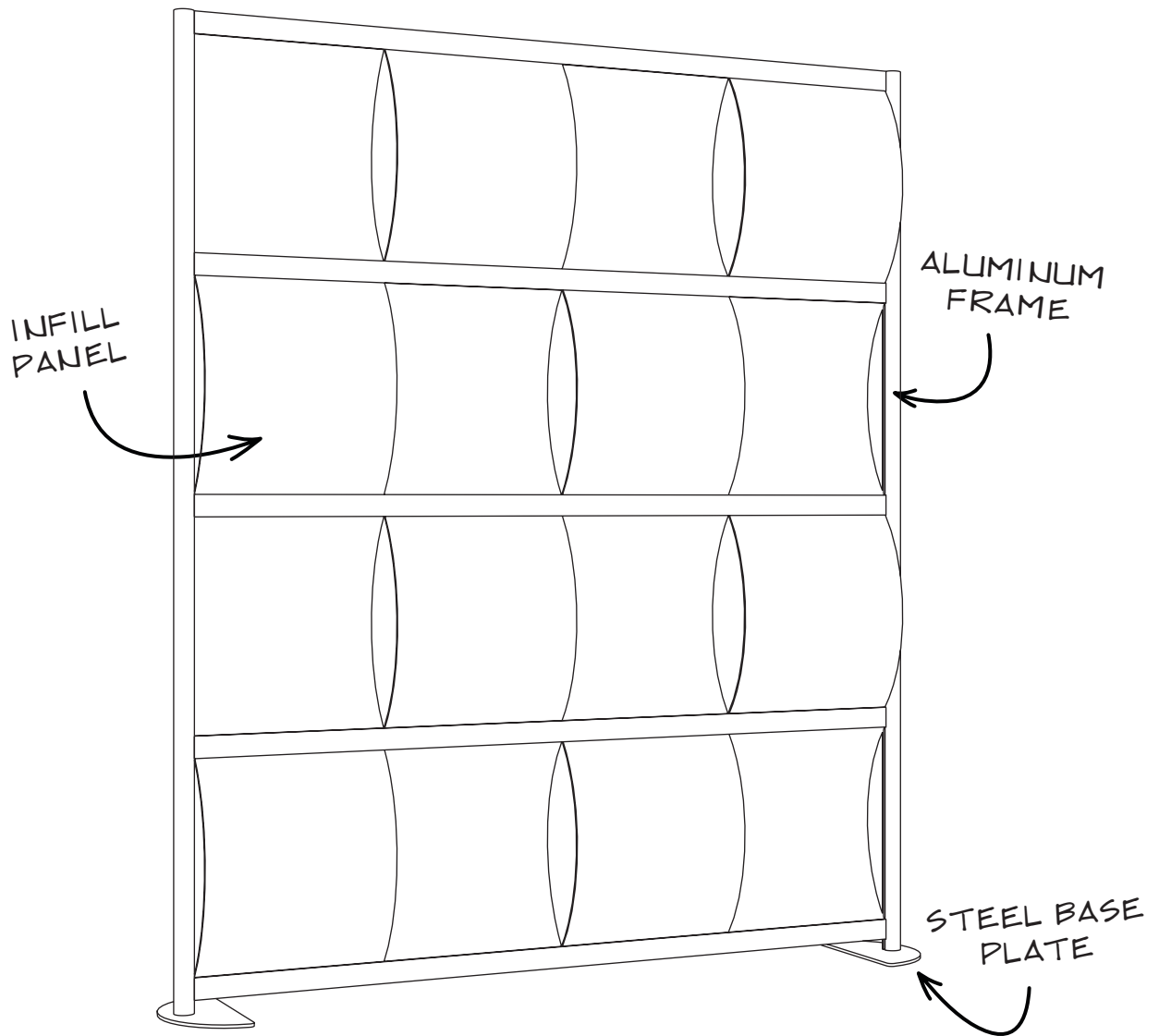

\*AVAILABLE IN ONE STANDARD HEIGHT AND  
THREE STANDARD WIDTHS

## Aluminum Frame Finishes



Anodized Aluminum

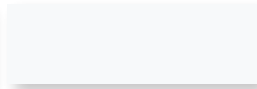

Glossy White



Matte Black

## Steel Base Plate Finishes



Anodized Aluminum



Glossy White



Matte Black

## Infill Panel Finishes

### WAVE PANEL



Gray

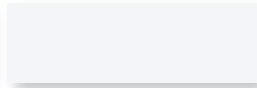

White

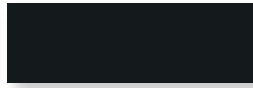

Black

# Weave room divider

wrap your space in more than just quiet

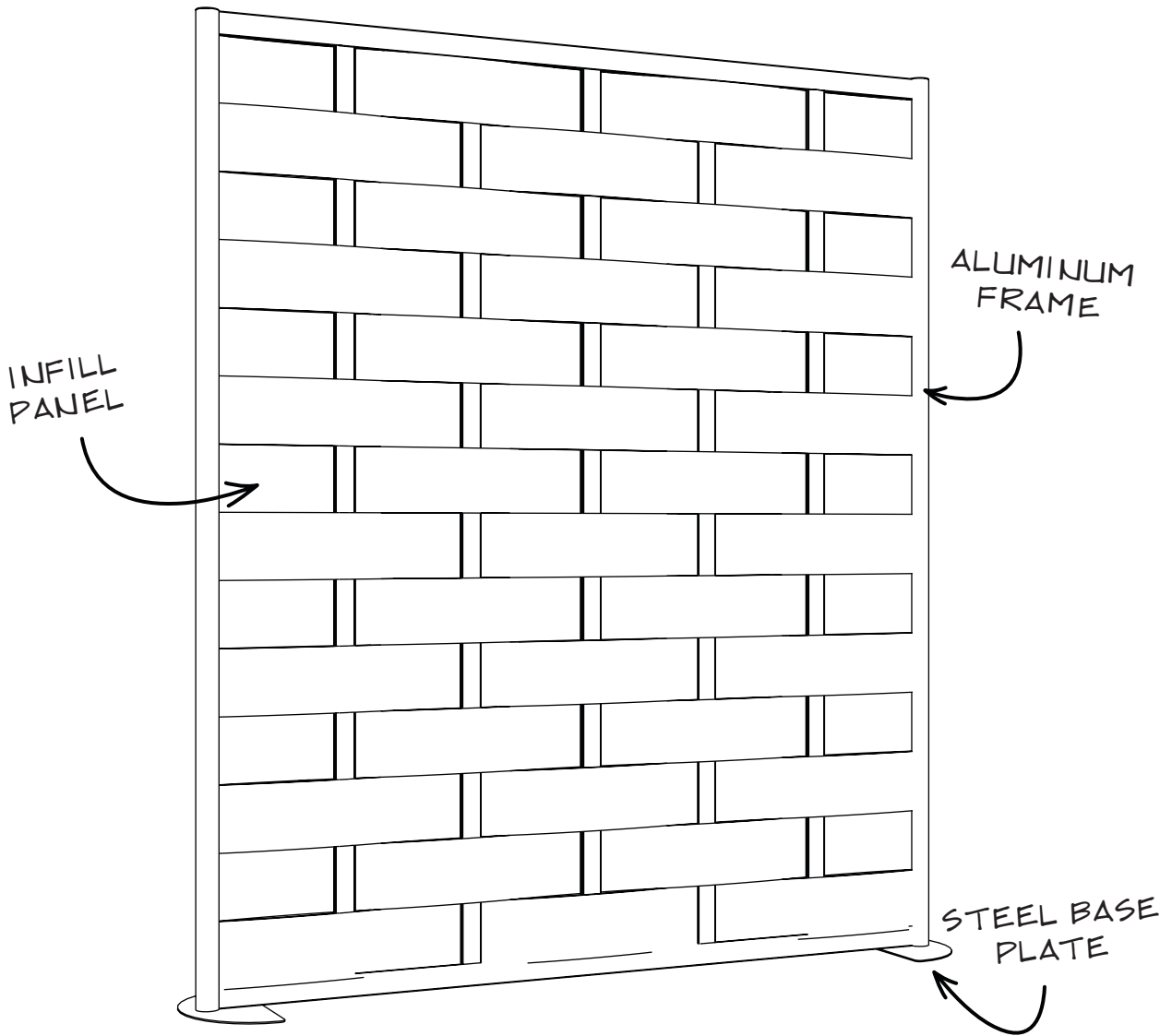

\*AVAILABLE IN TWO HEIGHTS AND THREE WIDTHS



## Aluminum Frame Finishes



Anodized Aluminum

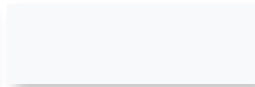

Glossy White



Matte Black

## Steel Base Plate Finishes



Anodized Aluminum



Glossy White



Matte Black

## Infill Panel Finishes

### ACOUSTIC PET



Brick



Pumpkin Spice



Cherry



Carrot



Sunflower



Straw



Lime



Guac



Ice

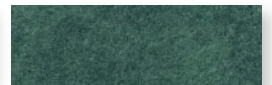

Seafoam



Peacock



Sapphire



Cobalt



Midnight



Grape



Bark



Concrete



Sand

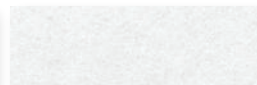

Snow



Pewter



Marble



Steel



Charcoal



Raven

# Web room divider

for when you need to let some light in

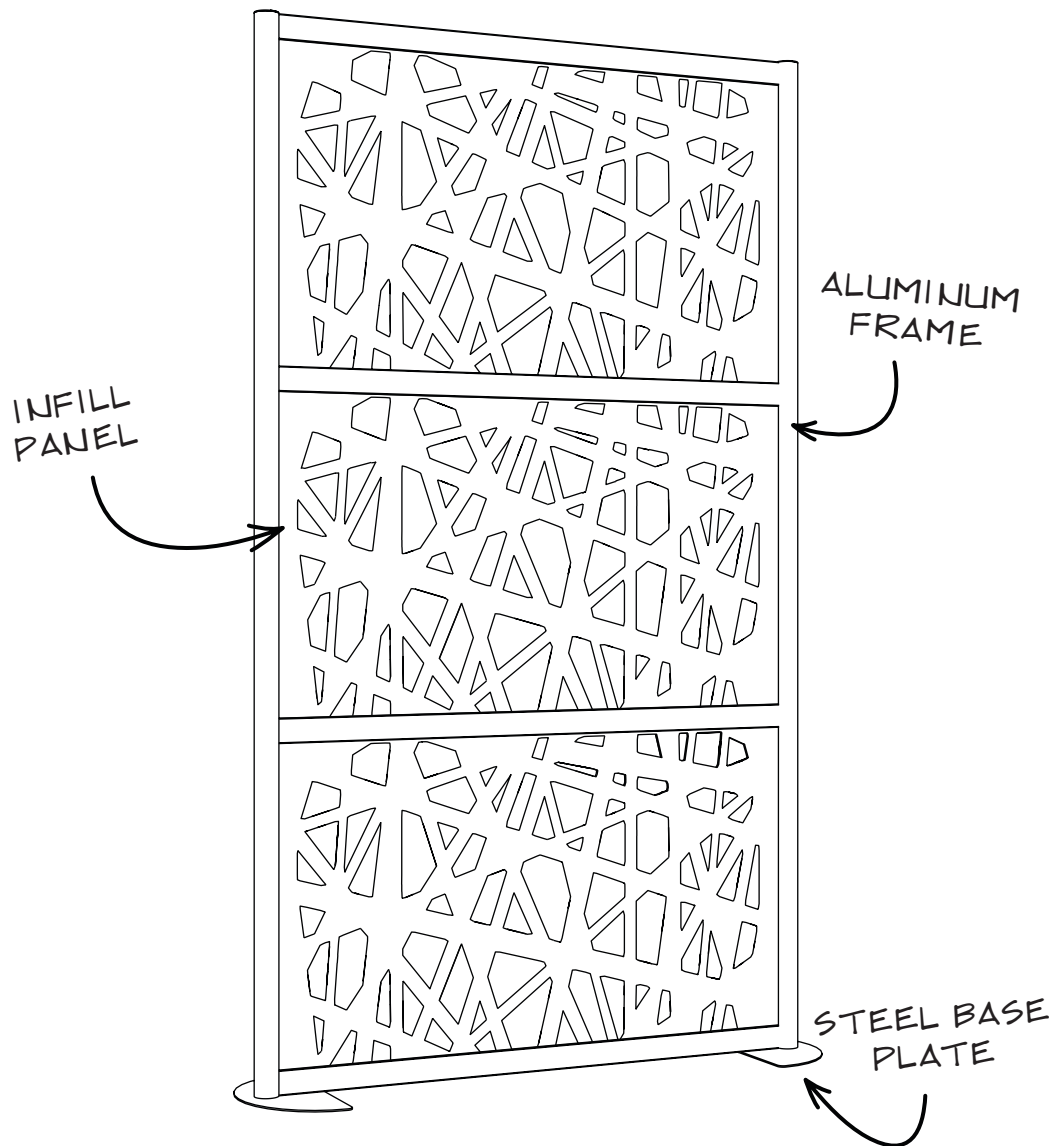

\*AVAILABLE IN TWO HEIGHTS, FIVE WIDTHS  
& A VARIETY OF DESIGN STYLES

## Aluminum Frame Finishes



Anodized Aluminum



Glossy White



Matte Black

## Steel Base Plate Finishes



Anodized Aluminum

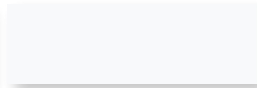

Glossy White



Matte Black

## Infill Panel Finishes

### HDPE



Gray

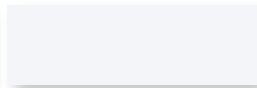

White



Black

# Counter Shield desk divider

a family of healthcare-grade sneeze guards

## Lite Style

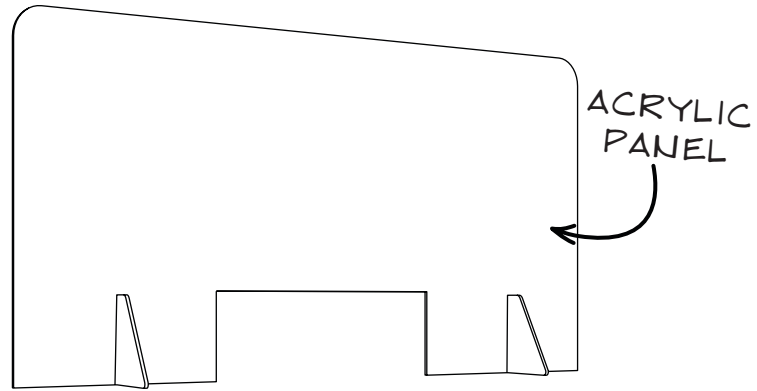

## Basic Style

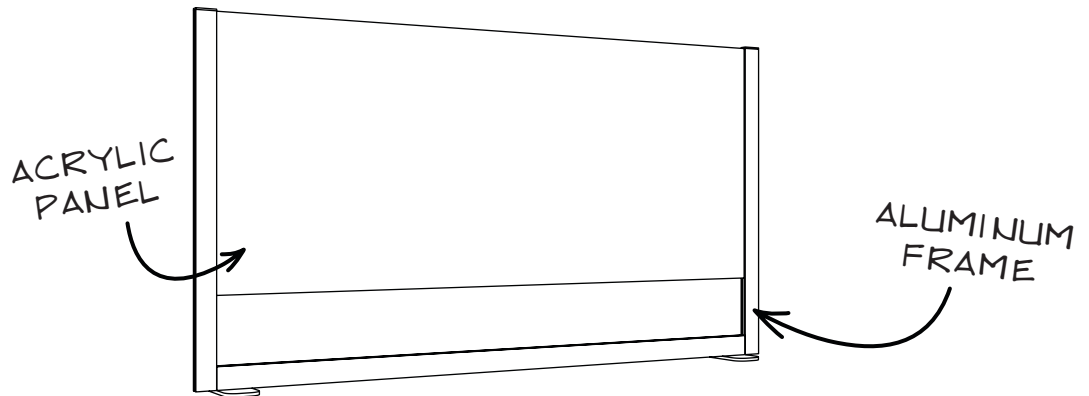

## Classic Style

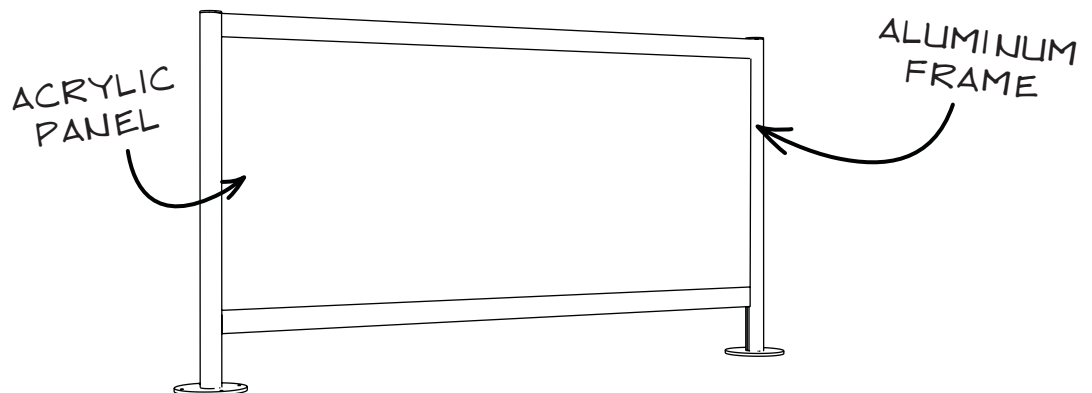

## Wrap Style

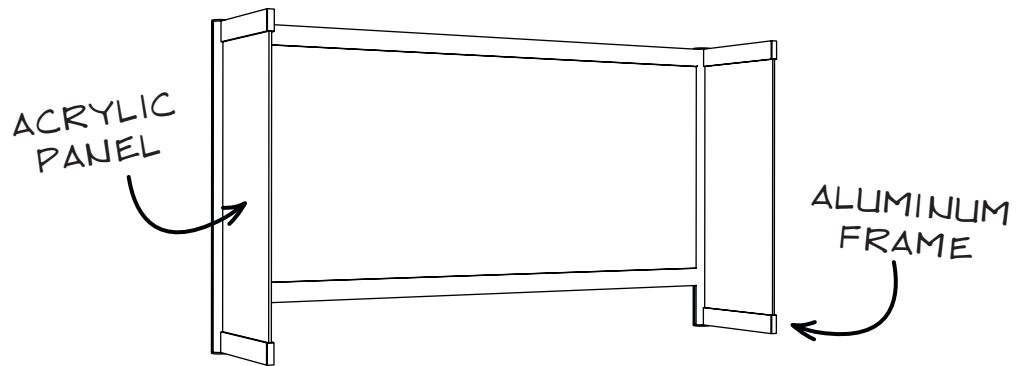

\*ALL COUNTER SHIELDS ARE AVAILABLE IN TWO WIDTHS,  
SMALL & LARGE

## Aluminum Frame Finishes



Anodized Aluminum



Glossy White



Matte Black

## Acrylic Panel Finishes

### TRANSLUCENT

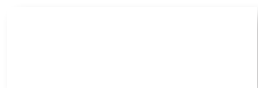

Clear Acrylic



\*Frosted Acrylic

\*Frosted Acrylic is available on all Counter Shield styles except for Lite

# Desk Shield desk divider

a refuge from distractions and germs

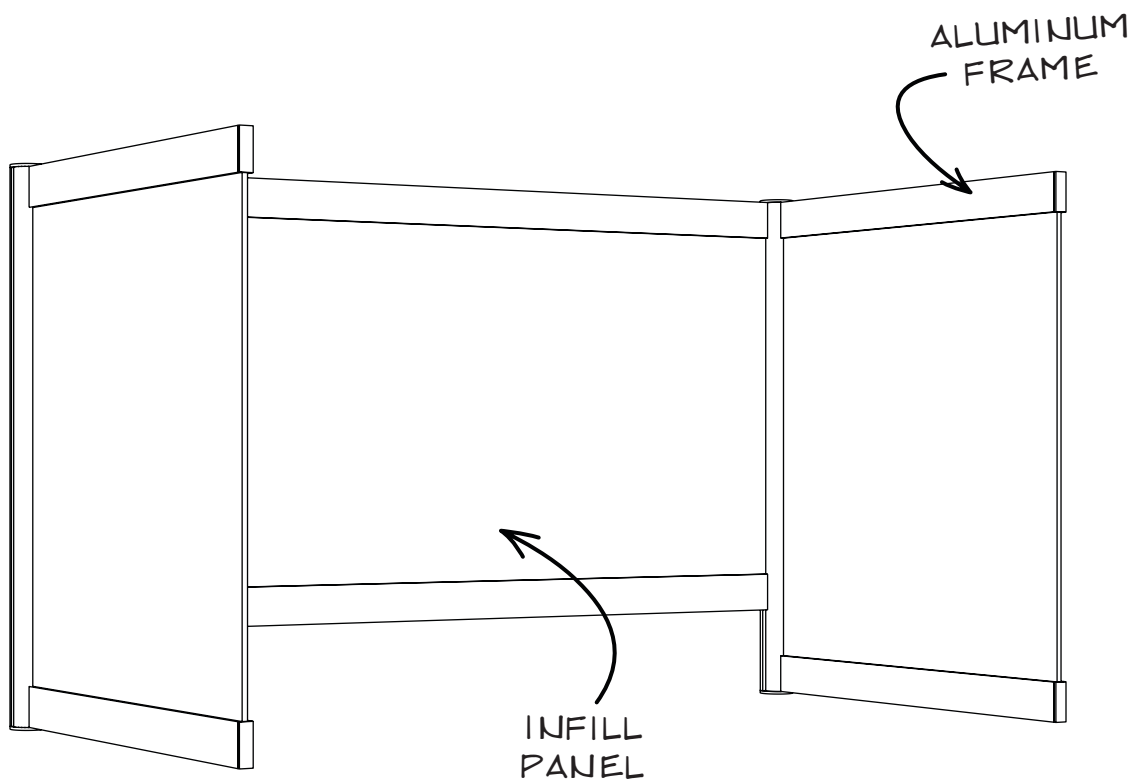

\*AVAILABLE IN ONE HEIGHT OPTION, THREE WIDTHS  
AND TWO DEPTHS

## Aluminum Frame Finishes



Anodized Aluminum



Glossy White



Matte Black

\*Brackets are made of steel

## Infill Panel Finishes

### TRANSLUCENT



Frosted Acrylic

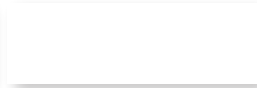

Clear Acrylic

# Hide desk divider

a hassle-free way to escape from chaos

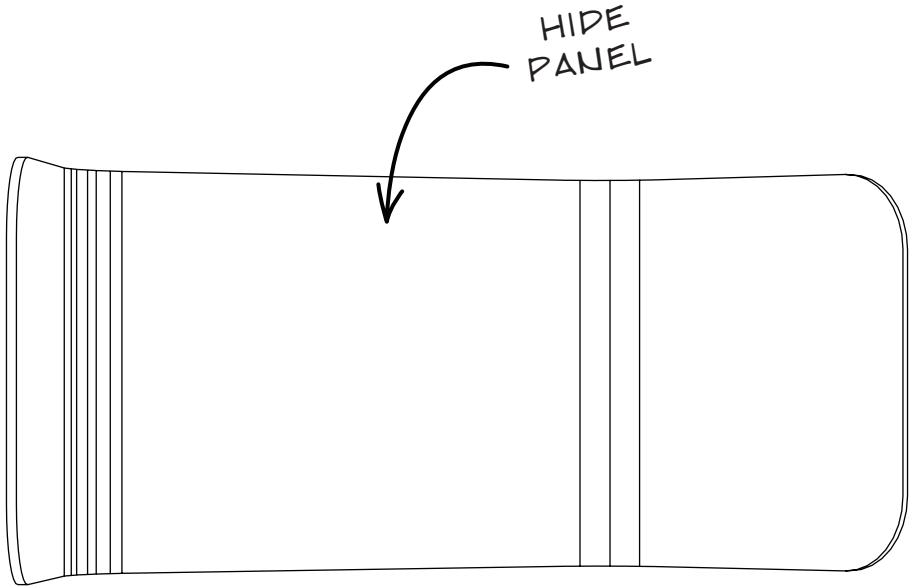

\*AVAILABLE IN ONLY ONE SIZE



# Hide Panel Finishes

## ACOUSTIC PET

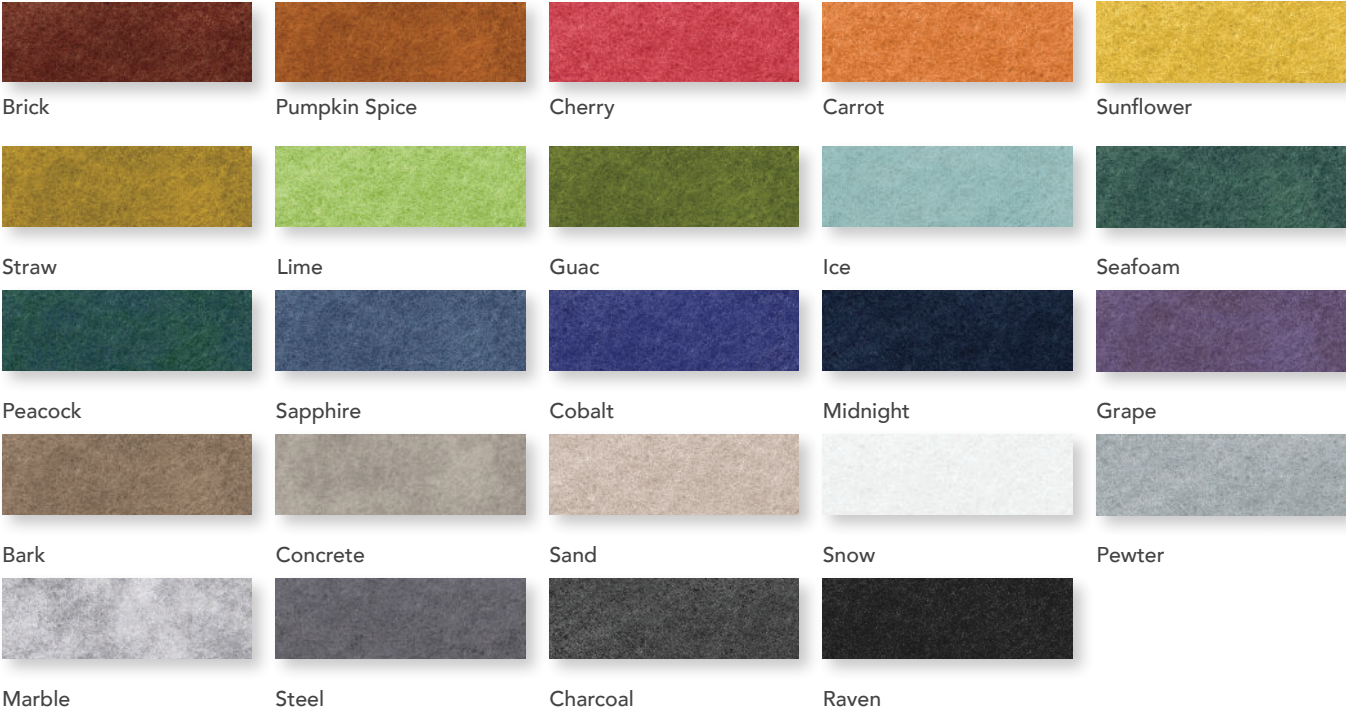

# Hitch desk divider

tie privacy to any workstation

## Single Hitch

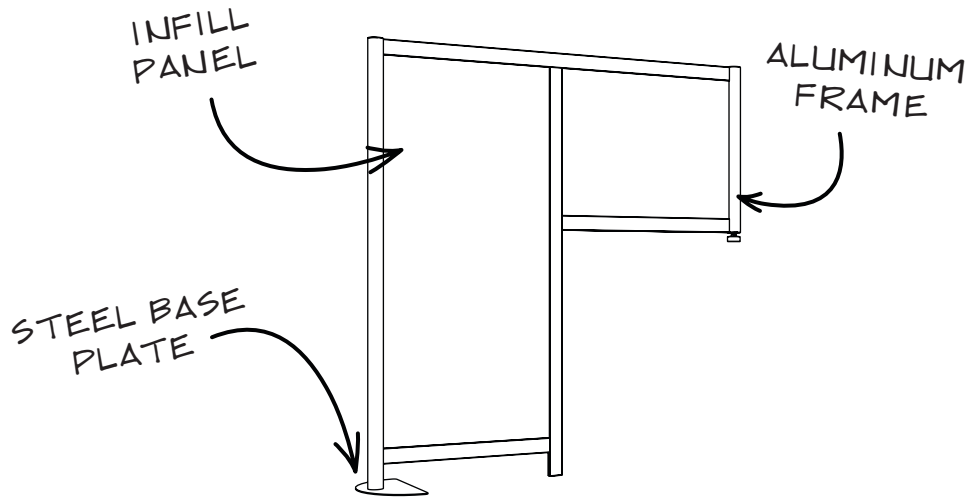

\*AVAILABLE IN ONE HEIGHT AND TWO WIDTHS

## Double Hitch

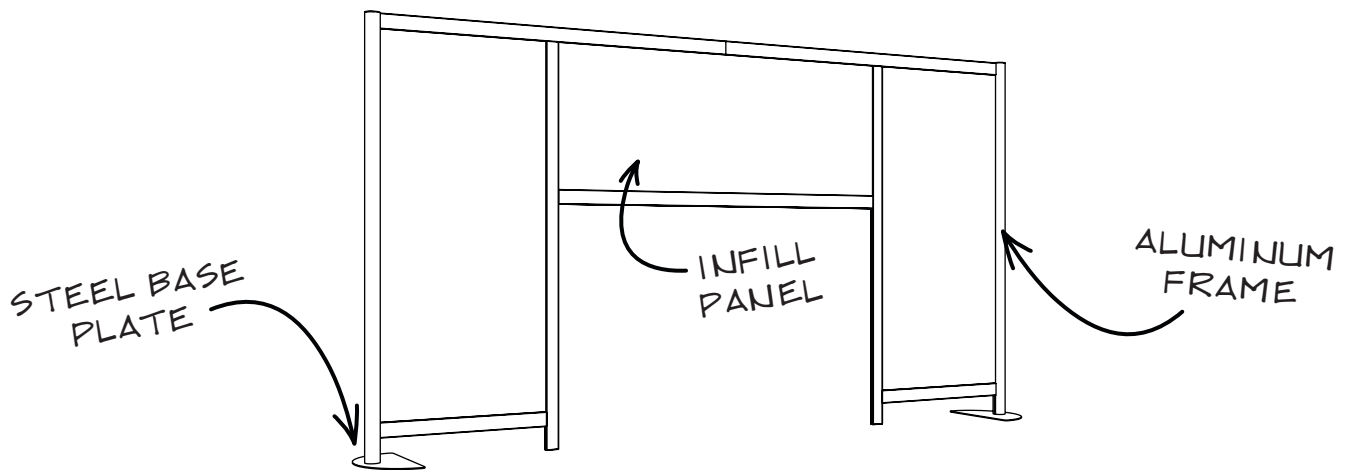

\*AVAILABLE IN ONE HEIGHT AND FOUR WIDTHS

## Aluminum Frame Finishes



Anodized Aluminum

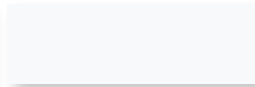

Glossy White



Matte Black

## Steel Base Plate Finishes



Anodized Aluminum



Glossy White



Matte Black

## Infill Panel Finishes

### LAMINATE



Maroon



Teal



Navy



Slate Blue



Gray

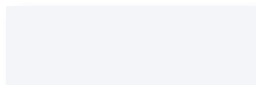

White



Black



Walnut



Oak



Elm

### ACOUSTIC PET



Brick



Pumpkin Spice



Cherry



Carrot



Sunflower



Straw



Lime



Guac



Ice



Seafoam

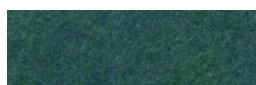

Peacock



Sapphire



Cobalt



Midnight



Grape



Bark



Concrete



Sand

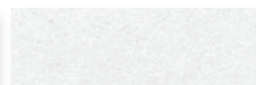

Snow



Pewter



Marble



Steel



Charcoal



Raven

# Infill Panel Finishes

## ACOUSTIC PET (CONTINUED)

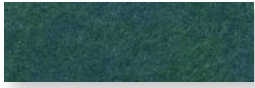

Peacock



Sapphire

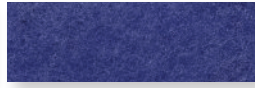

Cobalt



Midnight

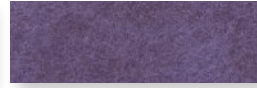

Grape



Bark



Concrete



Sand

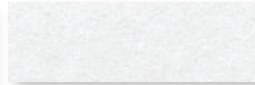

Snow



Pewter



Marble



Steel



Charcoal

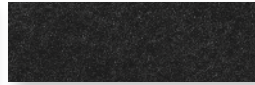

Raven

## WRITABLE

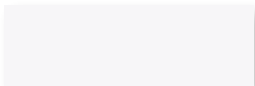

Non-magnetic Dry Erase

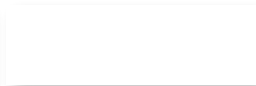

Magnetic Dry Erase

## TRANSLUCENT

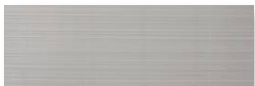

Twinwall Clear

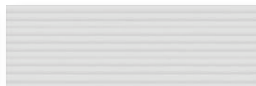

Twinwall White

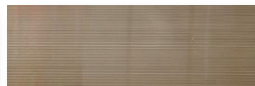

Twinwall Smoke



Frosted Acrylic

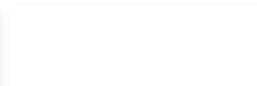

Clear Acrylic

## SPECIALTY PANEL FINISHES



Pegboard



COM Textile



Custom Logo

# Parallel desk divider

the most flexible way to divide your desk

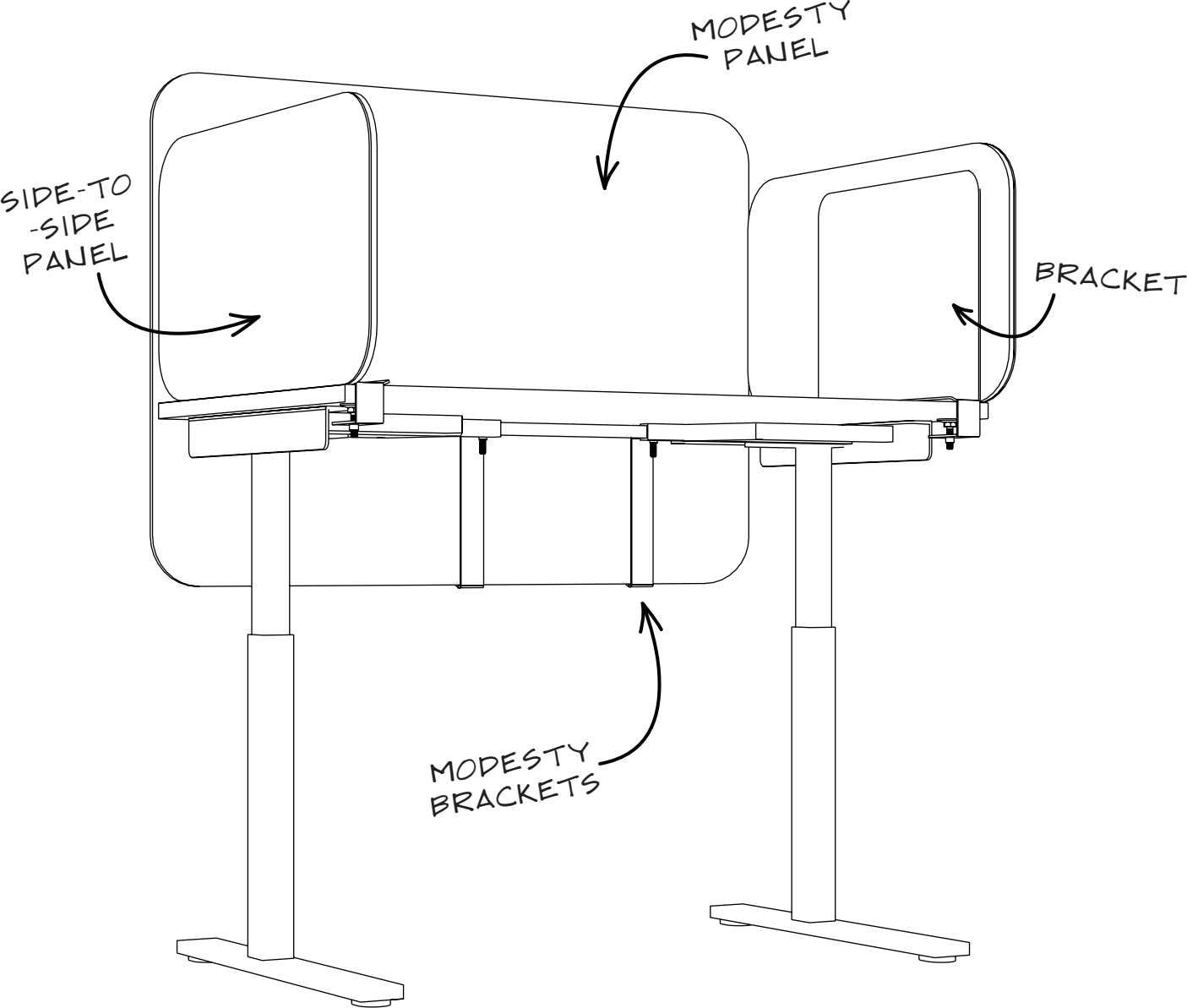

\*DESK NOT INCLUDED

## Bracket Finishes

### WRITABLE

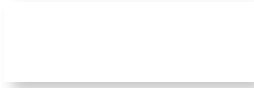

Magnetic Dry Erase

## Modesty Bracket Finishes

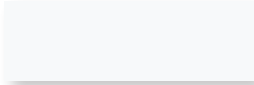

Glossy White

## Panel Finishes

### ACOUSTIC PET



Marble



Charcoal

## Optional Exterior Felt Finishes

### FELT



Tomato Red



Spruce Blue



Emerald Green



Light Gray

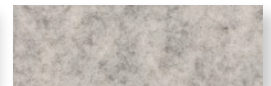

Almost White



Charcoal



Navy



Medium Gray

# Shelter desk divider

a safe place to touchdown and work

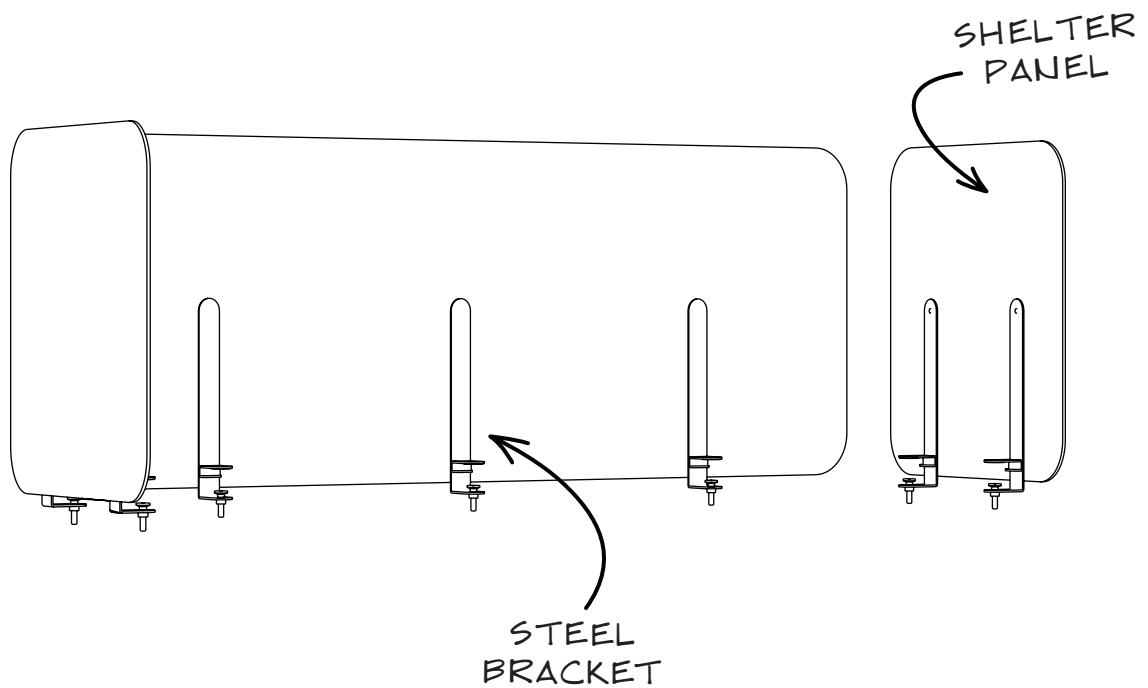

\*AVAILABLE IN TWO HEIGHTS AND A VARIETY OF WIDTHS AND DEPTHS; AS WELL AS MOUNTING ORIENTATIONS.

## Steel Bracket Finishes



Silver

## Shelter Panel Finishes

### ACOUSTIC PET

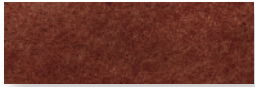

Brick



Pumpkin Spice



Cherry



Carrot



Sunflower



Straw



Lime



Guac



Ice

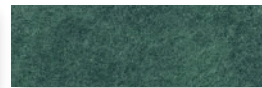

Seafoam

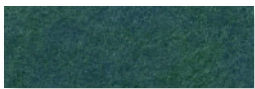

Peacock



Sapphire



Cobalt



Midnight



Grape



Bark

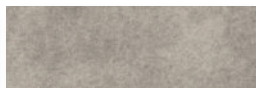

Concrete



Sand

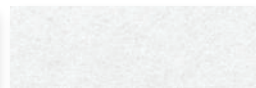

Snow



Pewter



Marble



Steel



Charcoal



Raven

### TRANSLUCENT



Frosted Acrylic

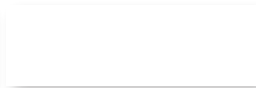

Clear Acrylic



# Arbor wall coverings

Beautiful, sound-dampening slatted wood wall panels

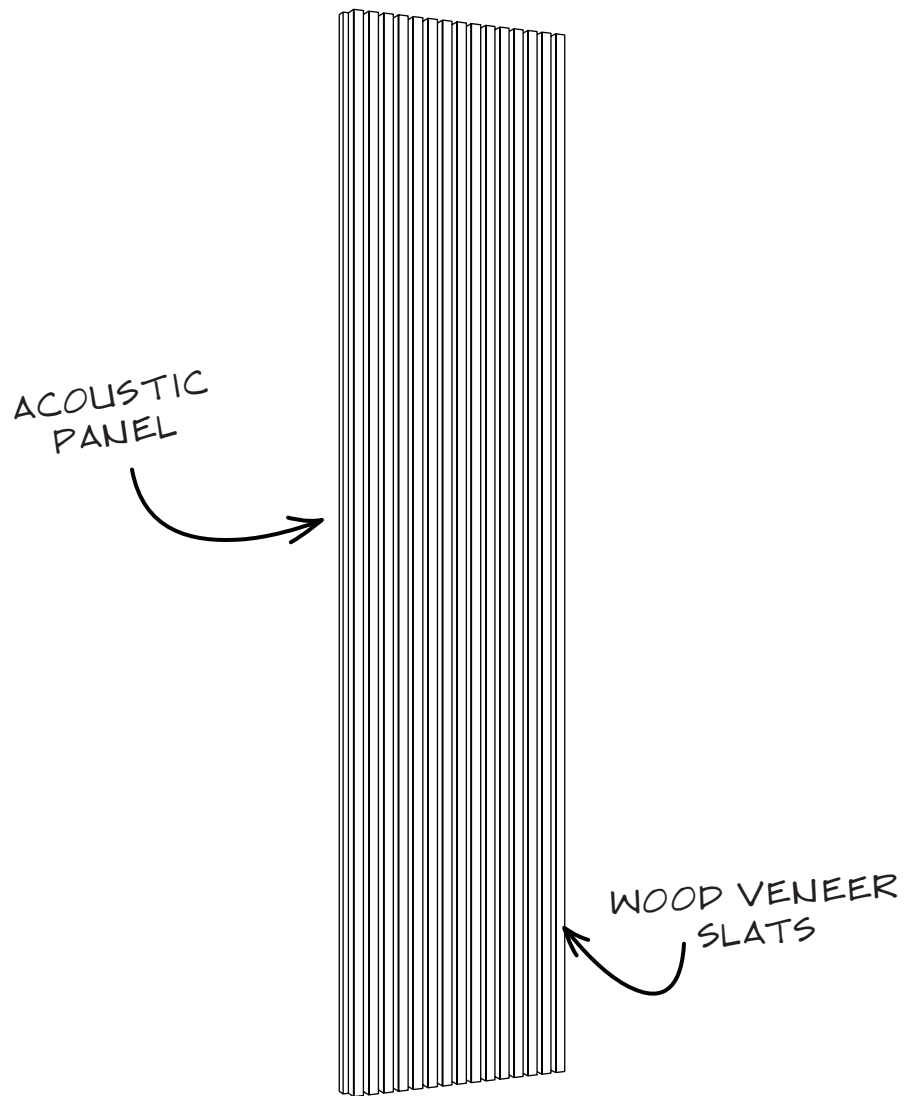

\*AVAILABLE IN TWO HEIGHTS AND TWO DEPTHS

# Wood Veneer Slat Finishes

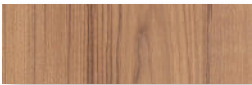

Teak

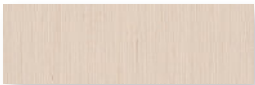

Oak



Walnut

# Acoustic Panel Finishes

## ACOUSTIC PET

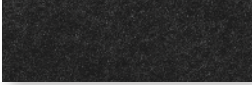

Raven

# Tango wall coverings

sound-reducing modular wall tiles

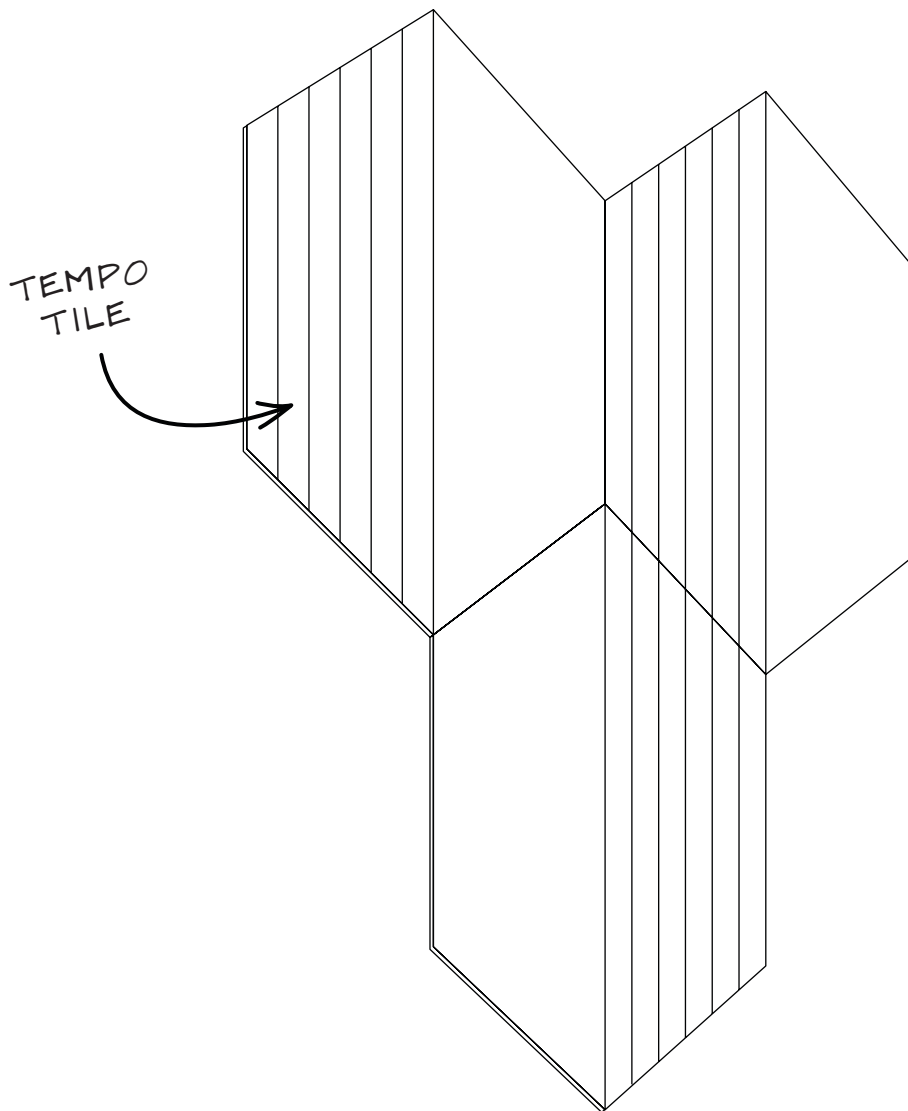

\*AVAILABLE IN EIGHT SHAPES, TWO SIZES AND THREE STYLES

# Tango Tile Finishes

## ACOUSTIC PET



## Tango Tile Cut Designs and Sizes

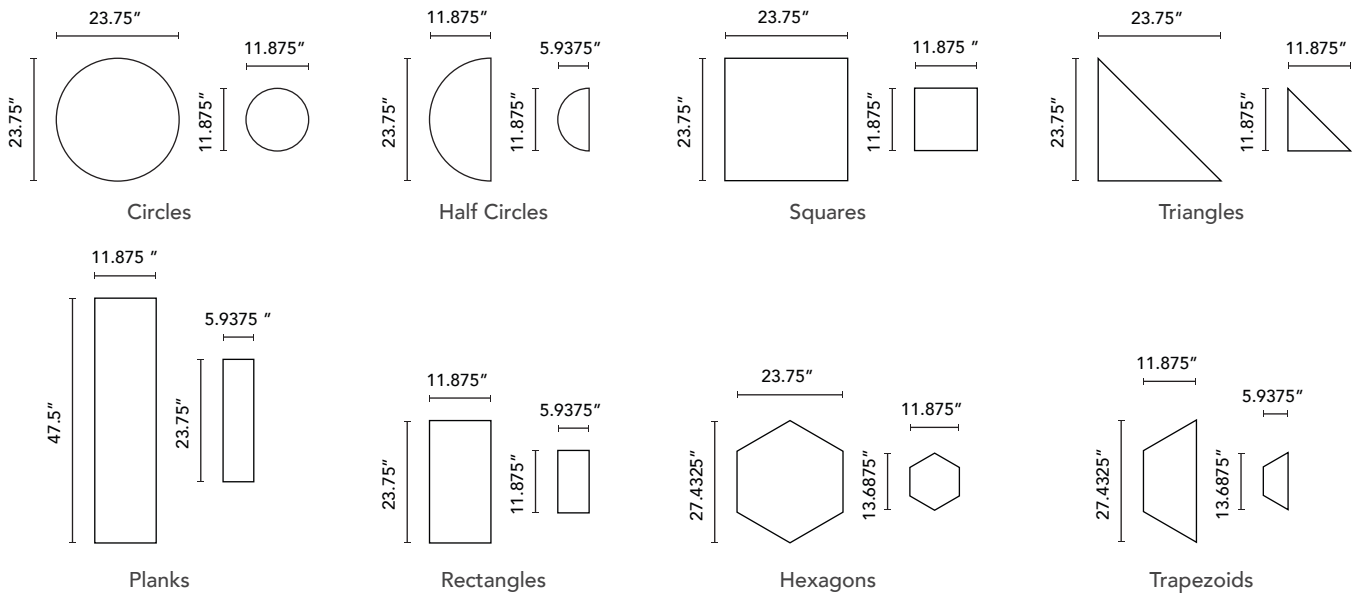

# Tempo Wall wall coverings

turn down the volume, with style

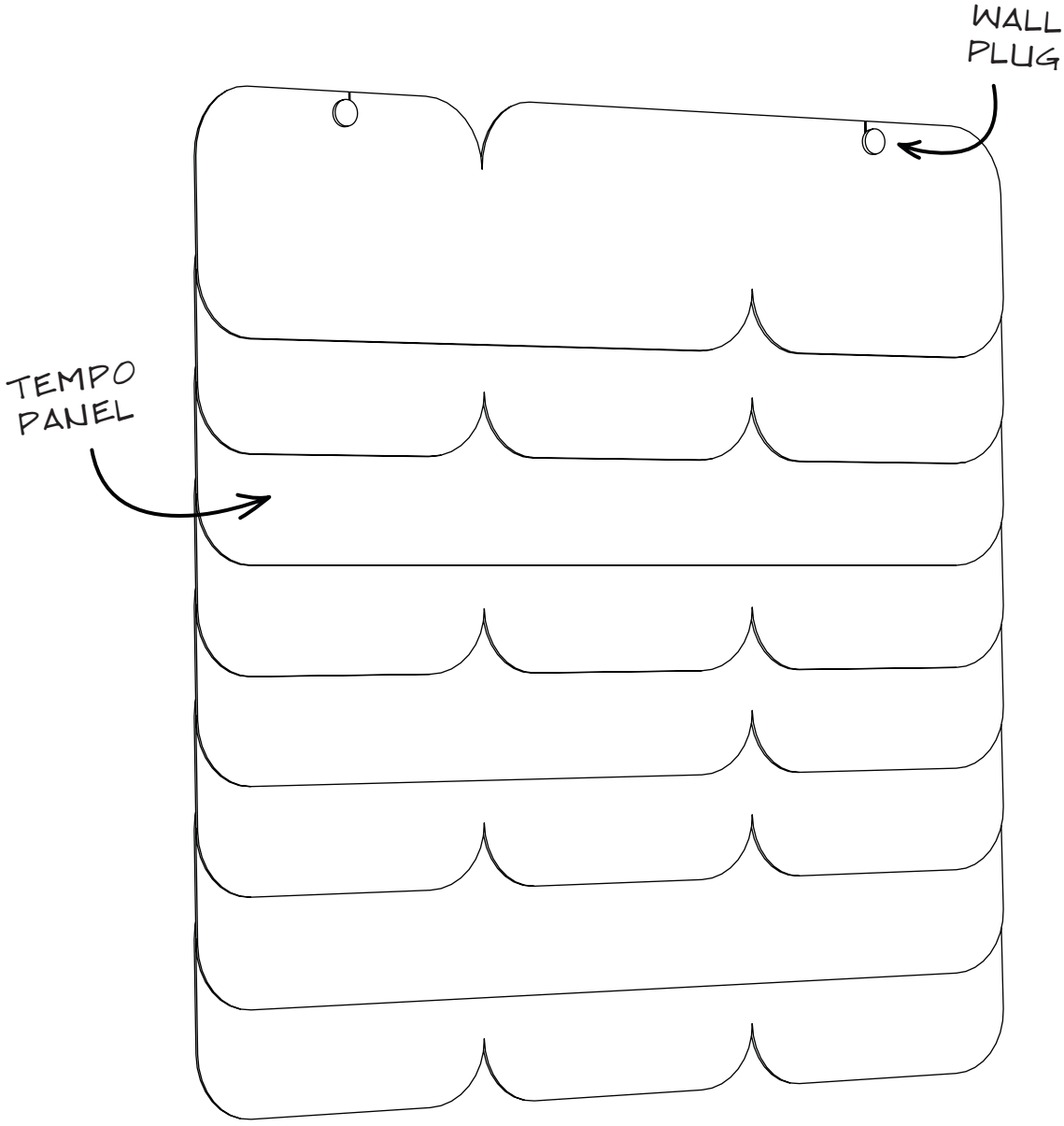

\*AVAILABLE IN TWELVE PANEL STYLES AND  
SOLD IN 4' X 4' GRID SYSTEMS

# Wall Plug Finishes



Cork

# Tempo Panel Finishes

## ACOUSTIC PET

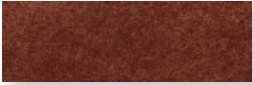

Brick



Pumpkin Spice

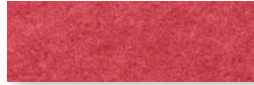

Cherry



Carrot



Sunflower



Straw



Lime



Guac



Ice

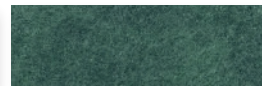

Seafoam



Peacock



Sapphire



Cobalt



Midnight



Grape



Bark



Concrete



Sand

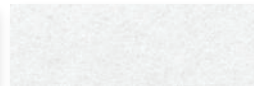

Snow



Pewter



Marble



Steel



Charcoal



Raven

# Tempo Panel Designs



Turn 1



Turn 2

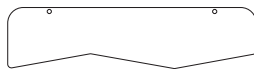

Turn 3



Tilt 1



Tilt 2

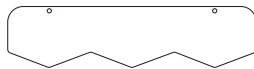

Tilt 3



Tab 1



Tab 2



Tab 3



Tide 1



Tide 2



Tide 3

# Glide architectural

sliding privacy, concealed magic

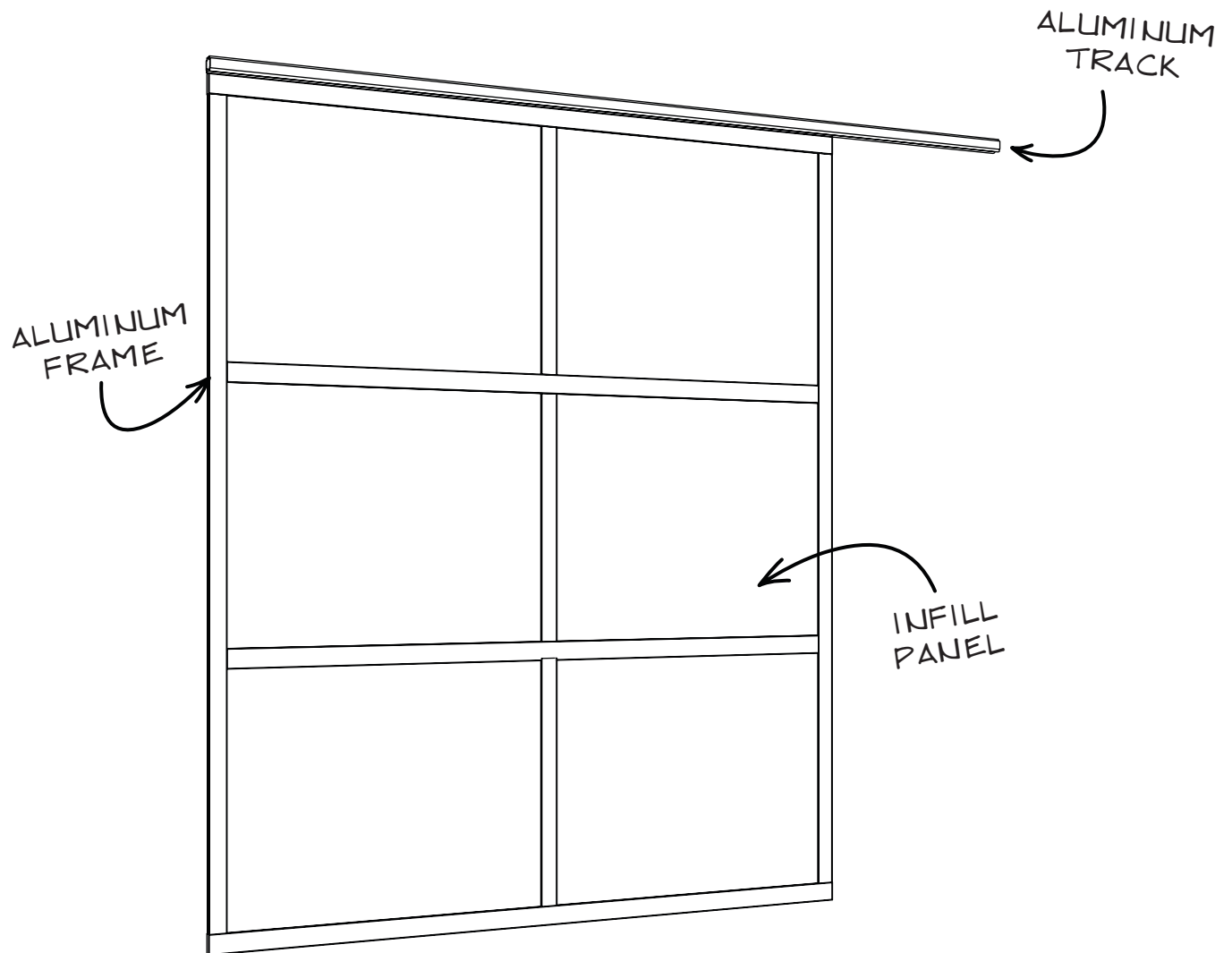

\*AVAILABLE IN THREE HEIGHTS, TWO WIDTHS

## Aluminum Frame Finishes



Anodized Aluminum



Glossy White



Matte Black

## Infill Panel Finishes

### LAMINATE



Maroon



Teal



Navy



Slate Blue



Gray

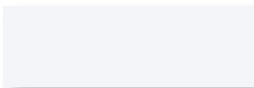

White



Black



Walnut



Oak



Elm

### ACOUSTIC PET



Brick



Pumpkin Spice



Cherry



Carrot



Sunflower



Straw



Lime



Guac



Ice

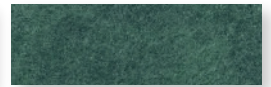

Seafoam

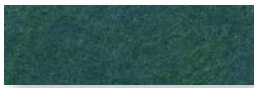

Peacock



Sapphire



Cobalt



Midnight



Grape



Bark



Concrete



Sand



Snow



Pewter



Marble



Steel



Charcoal



Raven

### TRANSLUCENT



Twinwall Clear

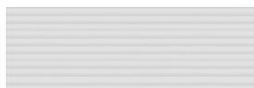

Twinwall White

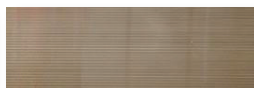

Twinwall Smoke



Frosted Acrylic

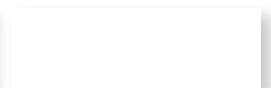

Clear Acrylic



# Infill Panel Finishes

## SPECIALTY PANEL FINISHES



Pegboard



COM Textile



Custom Logo

# Hover architectural

when full coverage privacy is needed

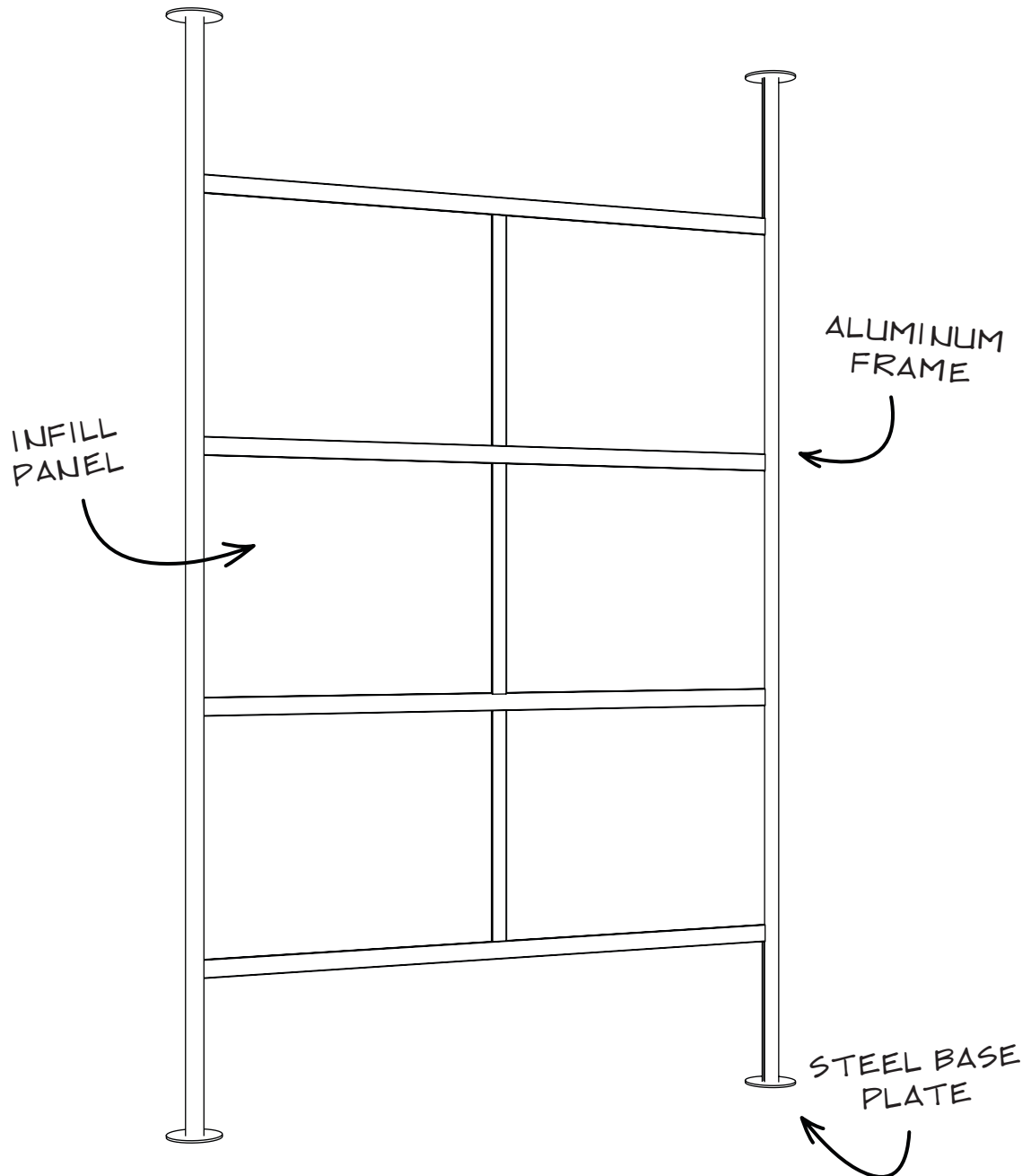

\*AVAILABLE IN TWO HEIGHTS, THREE WIDTHS  
& A VARIETY OF DESIGN STYLES

## Aluminum Frame Finishes



Anodized Aluminum

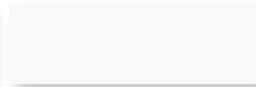

Glossy White



Matte Black

## Steel Base Plate Finishes



Anodized Aluminum



Glossy White



Matte Black

## Infill Panel Finishes

### LAMINATE



Maroon



Teal



Navy



Slate Blue



Gray

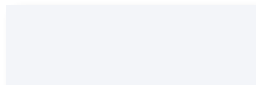

White



Black



Walnut



Oak



Elm

### BLOX



Tomato Red



Electric Green



Emerald Green



Spruce Blue



True Blue



Navy

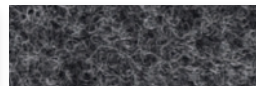

Charcoal



Medium Gray

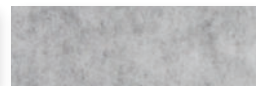

Light Gray

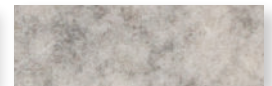

Almost White

\*Blox is made of premium polyester fibers\*\* Only available in 2' x 2' and 2' x 4' panels

### ACOUSTIC PET



Brick



Pumpkin Spice



Cherry



Carrot



Sunflower



Straw



Lime



Guac



Ice



Seafoam

# Infill Panel Finishes (continued)

## ACOUSTIC PET

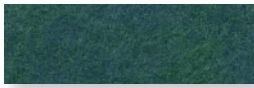

Peacock



Sapphire



Cobalt



Midnight



Grape



Bark



Concrete



Sand



Snow



Pewter



Marble



Steel



Charcoal

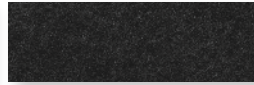

Raven

## WRITABLE

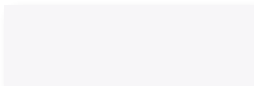

Non-magnetic Dry Erase

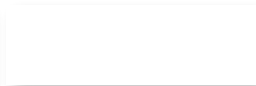

Magnetic Dry Erase

## TRANSLUCENT

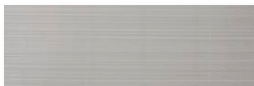

Twinwall Clear

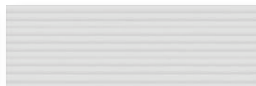

Twinwall White

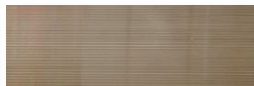

Twinwall Smoke



Frosted Acrylic

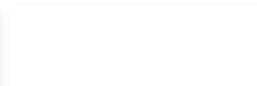

Clear Acrylic

## SPECIALTY PANEL FINISHES



Pegboard



COM Textile



Custom Logo

# Pivot architectural

a lot of privacy for a little footprint.

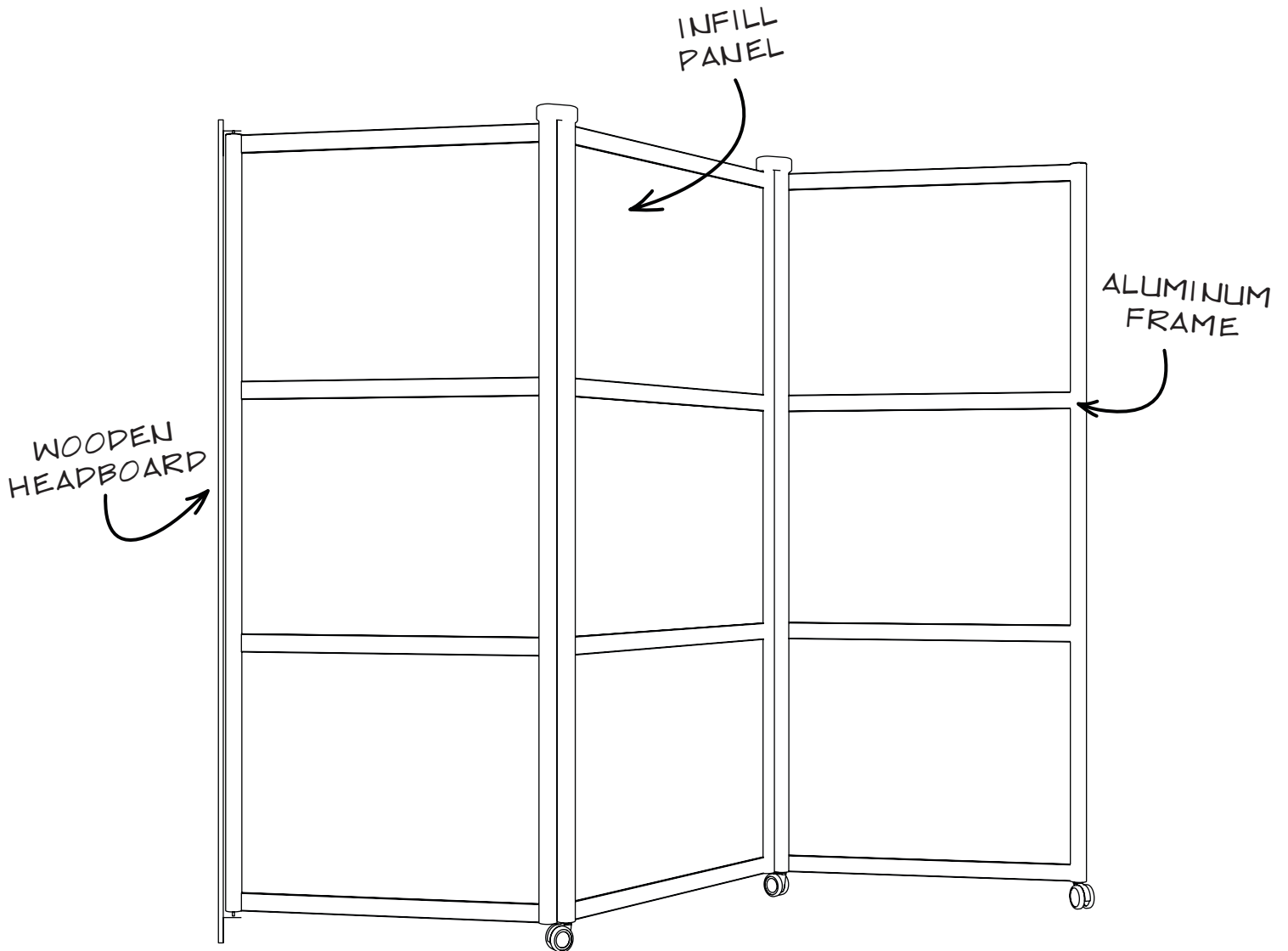

\*AVAILABLE IN TWO HEIGHTS, FOUR WIDTHS

## Aluminum Frame Finishes



Anodized Aluminum



Glossy White



Matte Black

## Wooden Headboard Finishes

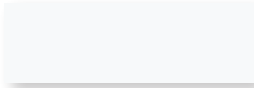

White

## Infill Panel Finishes

### LAMINATE



Maroon



Teal



Navy



Slate Blue



Gray

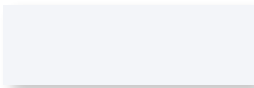

White



Black



Walnut

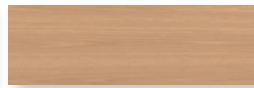

Oak



Elm

### ACOUSTIC PET



Brick



Pumpkin Spice



Cherry



Carrot



Sunflower



Straw



Lime



Guac



Ice

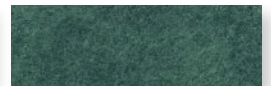

Seafoam



Peacock



Sapphire



Cobalt



Midnight



Grape



Bark



Concrete



Sand

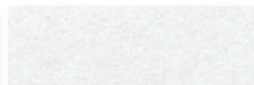

Snow



Pewter



Marble



Steel



Charcoal



Raven

# Infill Panel Finishes

## WRITABLE

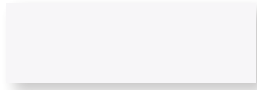

Non-magnetic Dry Erase

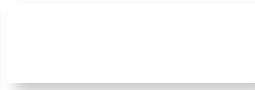

Magnetic Dry Erase

## TRANSLUCENT



Twinwall Clear

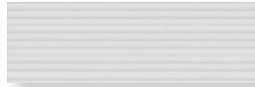

Twinwall White

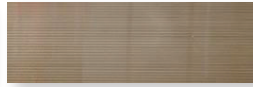

Twinwall Smoke



Frosted Acrylic

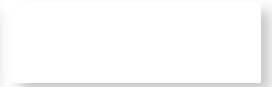

Clear Acrylic

## SPECIALTY PANEL FINISHES

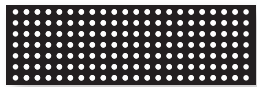

Pegboard



COM Textile



Custom Logo

# Rooms architectural

make space within your space

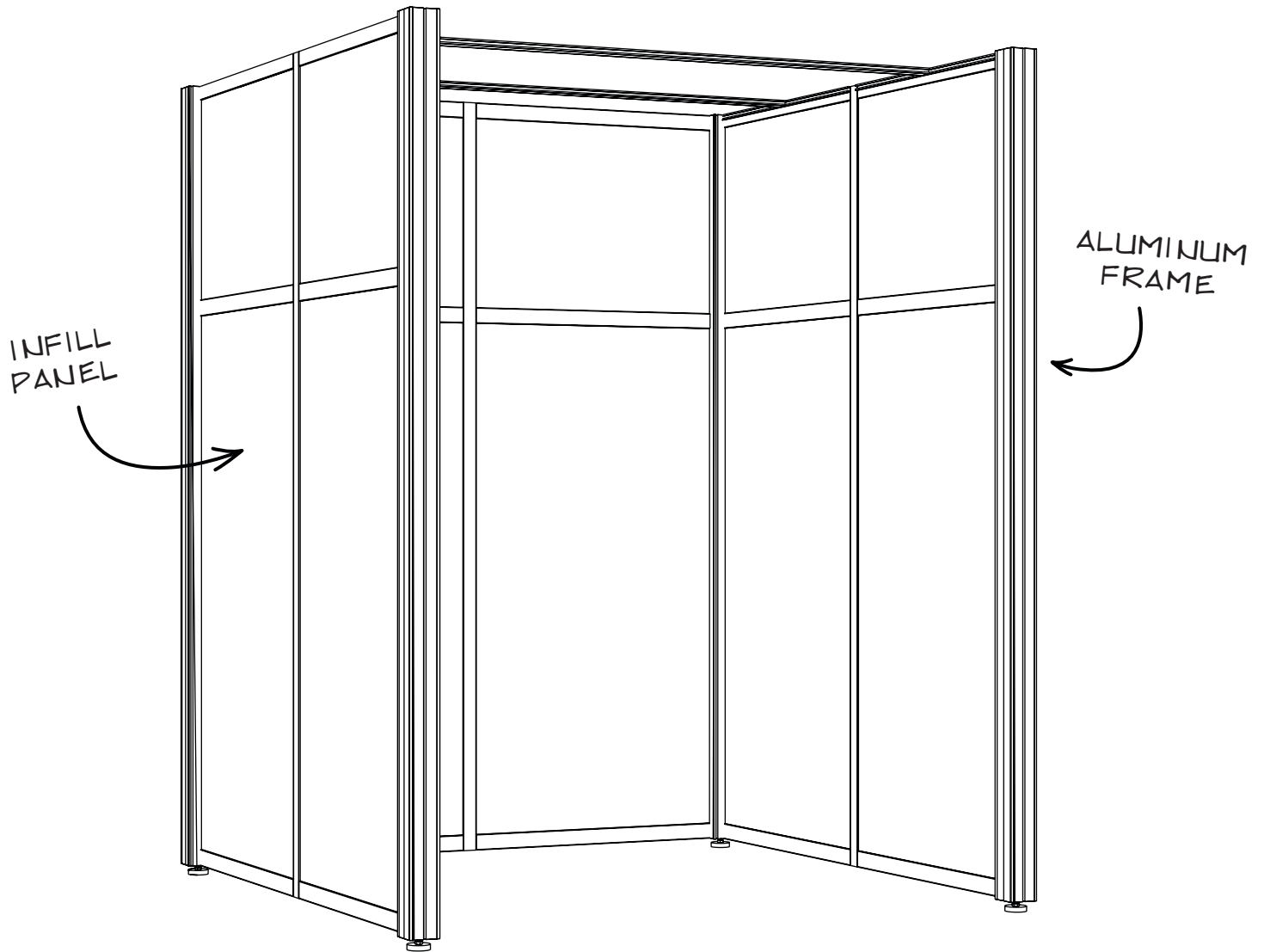

\*AVAILABLE IN TWO HEIGHTS, THREE WIDTHS  
& A VARIETY OF DESIGN STYLES



## Aluminum Frame Finishes



Anodized Aluminum



Glossy White



Matte Black

## Infill Panel Finishes

### LAMINATE



Maroon



Teal



Navy



Slate Blue



Gray

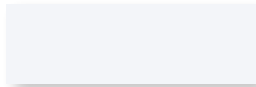

White



Black



Walnut



Oak



Elm

### \*BLOX



Tomato Red



Electric Green



Emerald Green



Spruce Blue



True Blue



Navy



Charcoal



Medium Gray



Light Gray

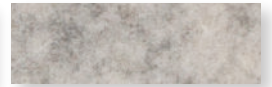

Almost White

\*Blox is only available in specific Room sizes, reach out to an account manager for more clarity \*\*Blox is made of premium polyester fibers

### ACOUSTIC PET



Brick



Pumpkin Spice

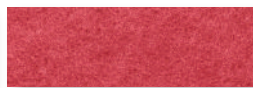

Cherry



Carrot



Sunflower



Straw

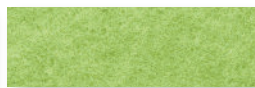

Lime



Guac

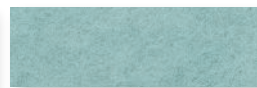

Ice



Seafoam



Peacock



Sapphire



Cobalt



Midnight



Grape



Bark



Concrete



Sand



Snow



Pewter

# Infill Panel Finishes

## ACOUSTIC PET (CONTINUED)



Marble

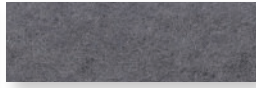

Steel



Charcoal

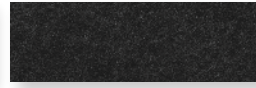

Raven

## WRITABLE

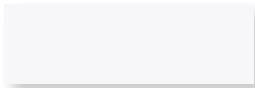

Non-magnetic Dry Erase

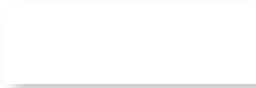

\*Magnetic Dry Erase

\*Magnetic Dry Erase panels are not available in Style 1 size panels

## TRANSLUCENT



Twinwall Clear

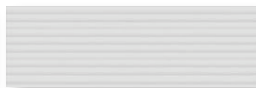

Twinwall White

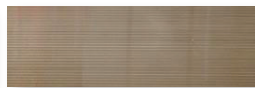

Twinwall Smoke



Frosted Acrylic

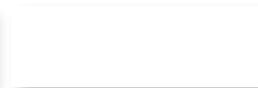

Clear Acrylic

## SPECIALTY PANEL FINISHES



COM Textile



Custom Logo

# Gravity acoustic baffle

acoustic division from above

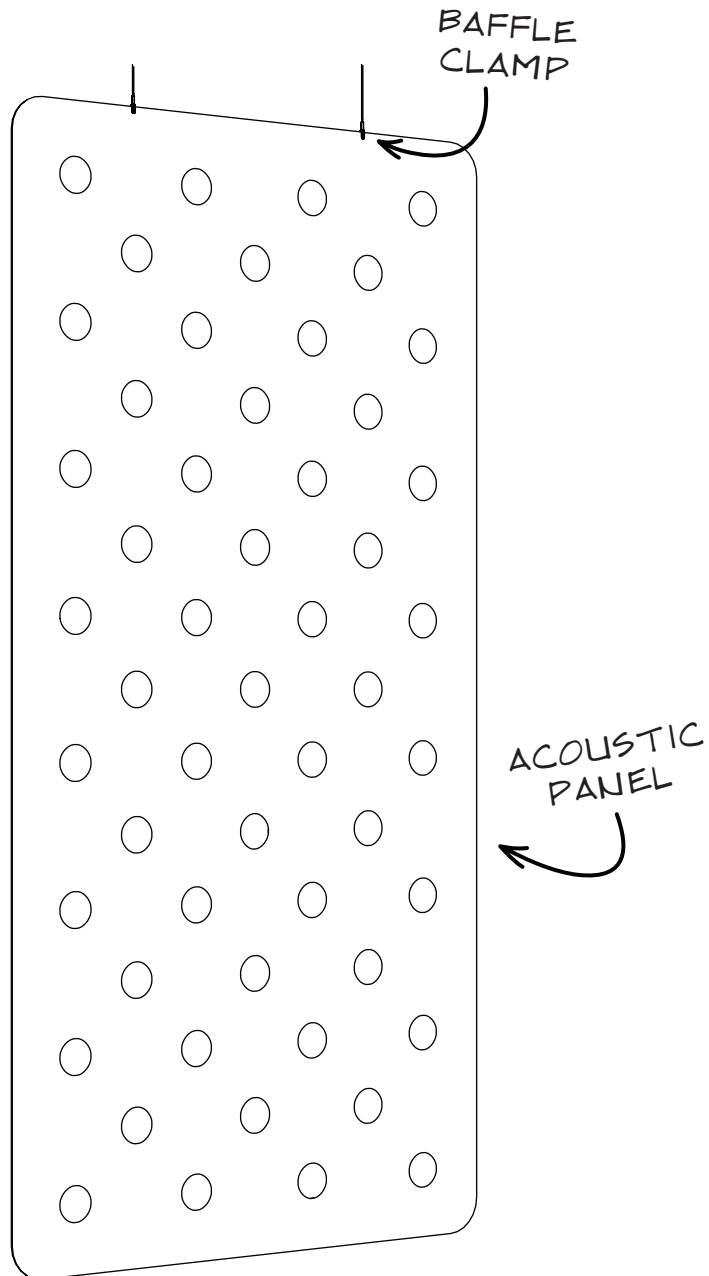

\*AVAILABLE IN TWO HEIGHTS, A VARIETY OF DESIGN STYLES AND FIVE MOUNTING METHODS

## Baffle Clamp Finishes

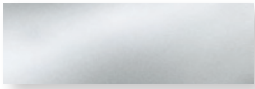

Silver

## Acoustic Panel Finishes

### ACOUSTIC PET



Brick



Pumpkin Spice



Cherry



Carrot



Sunflower



Straw

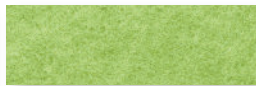

Lime



Guac



Ice



Seafoam



Peacock



Sapphire



Cobalt



Midnight



Grape



Bark



Concrete



Sand



Snow



Pewter



Marble



Steel



Charcoal



Raven

## Mounting Hardware Finishes



Silver



White



Black

## Gravity Panel Cut Designs



Slab

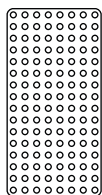

Perf



Halfsies



Slice

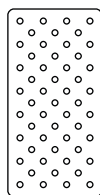

Offset

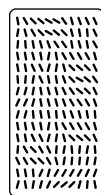

Scatter



Turn

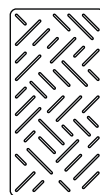

Hatch



Transit



Web

# Gravity Panel Cut Designs

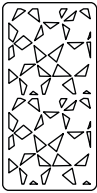

Fractal

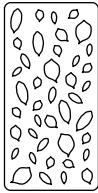

Petal

# Layer acoustic baffle

an array of acoustic ceiling panels

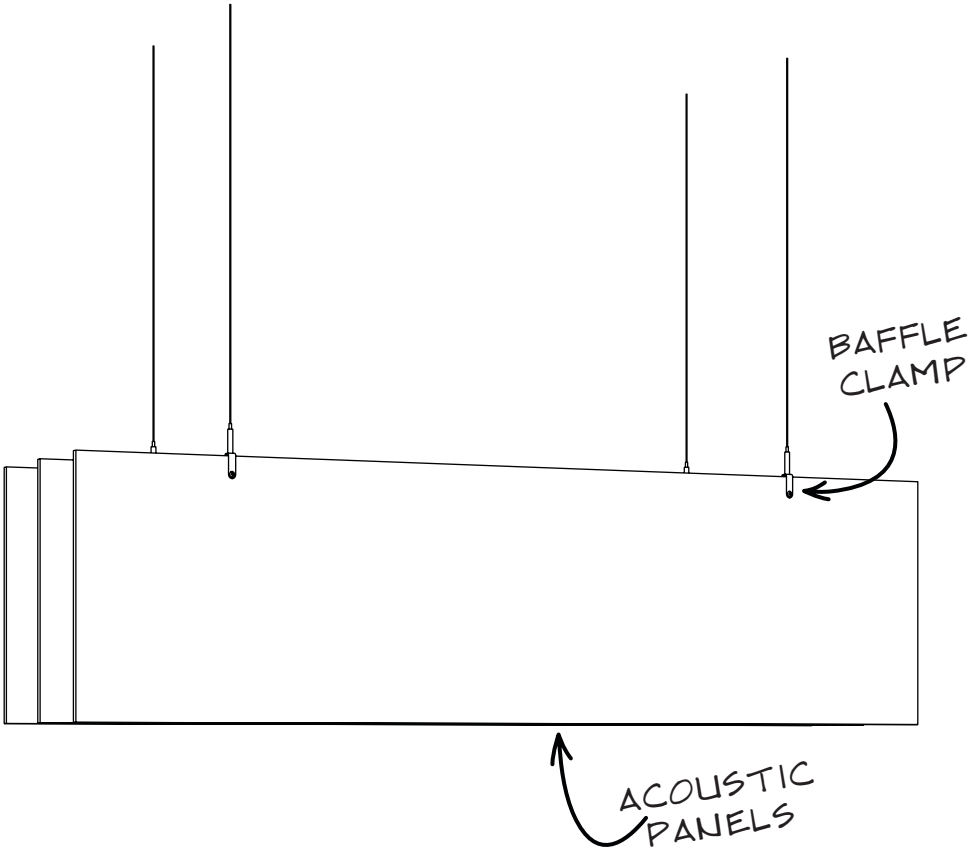

\*AVAILABLE IN THREE LENGTHS AND FOUR MOUNTING METHODS

## Baffle Clamp Finishes

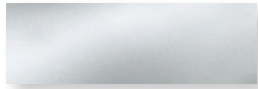

Silver

## Acoustic Panel Finishes

### ACOUSTIC PET



Brick



Pumpkin Spice



Cherry



Carrot



Sunflower



Straw



Lime



Guac



Ice

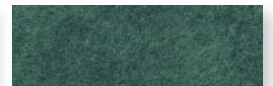

Seafoam



Peacock



Sapphire



Cobalt



Midnight



Grape



Bark



Concrete



Sand

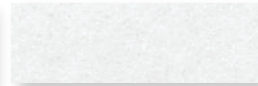

Snow



Pewter



Marble



Steel



Charcoal



Raven

## Mounting Hardware Finishes



Silver



White



Black

## Layer Panel Designs



Base



Pitch



Wave

# Pocket acoustic baffle

playful baffles designed to catch all of your unwanted sounds

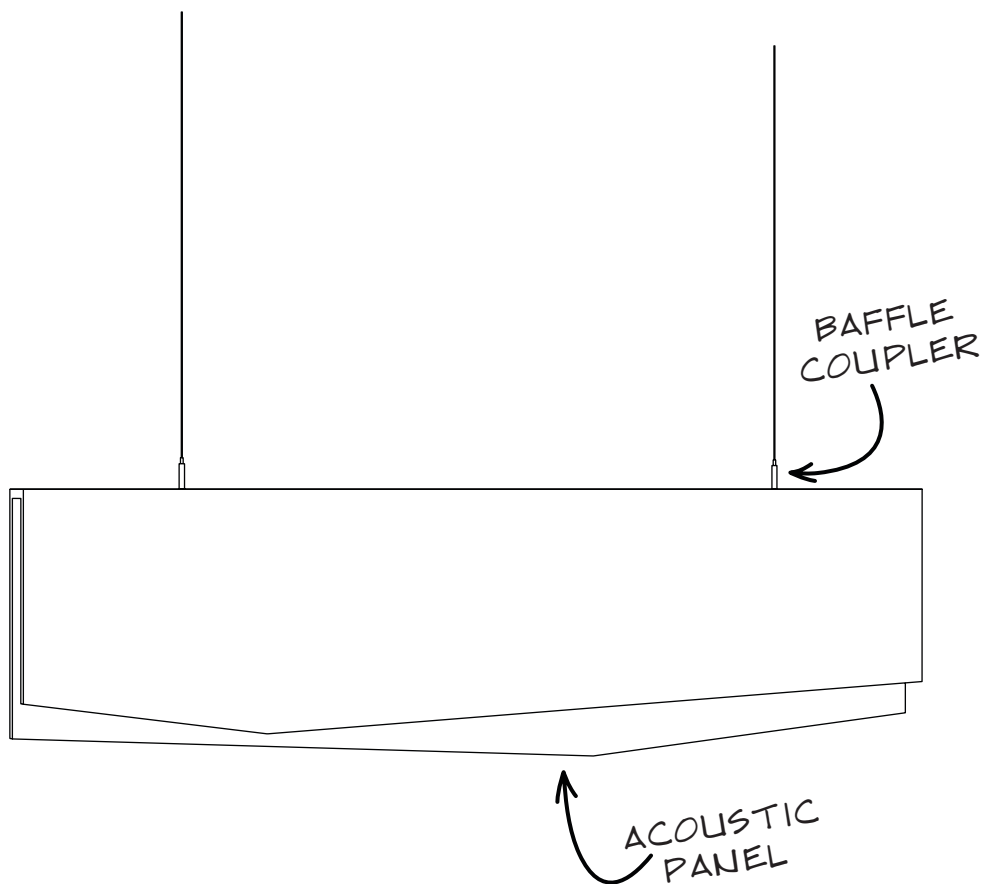

\*AVAILABLE IN THREE LENGTHS AND FOUR MOUNTING METHODS



## Baffle Coupler Finishes

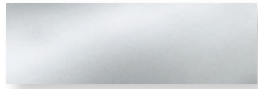

Silver

## Acoustic Panel Finishes

### ACOUSTIC PET



Brick



Pumpkin Spice



Cherry



Carrot



Sunflower



Straw



Lime



Guac



Ice

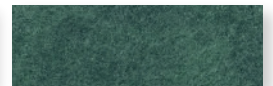

Seafoam



Peacock



Sapphire



Cobalt



Midnight



Grape



Bark



Concrete



Sand

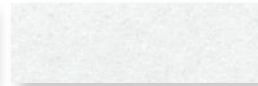

Snow



Pewter



Marble



Steel



Charcoal



Raven

## Mounting Hardware Finishes



Silver



White



Black

## Pocket Panel Designs



Base



Pitch



Wave

# Sky acoustic baffle

elevate your space, acoustically

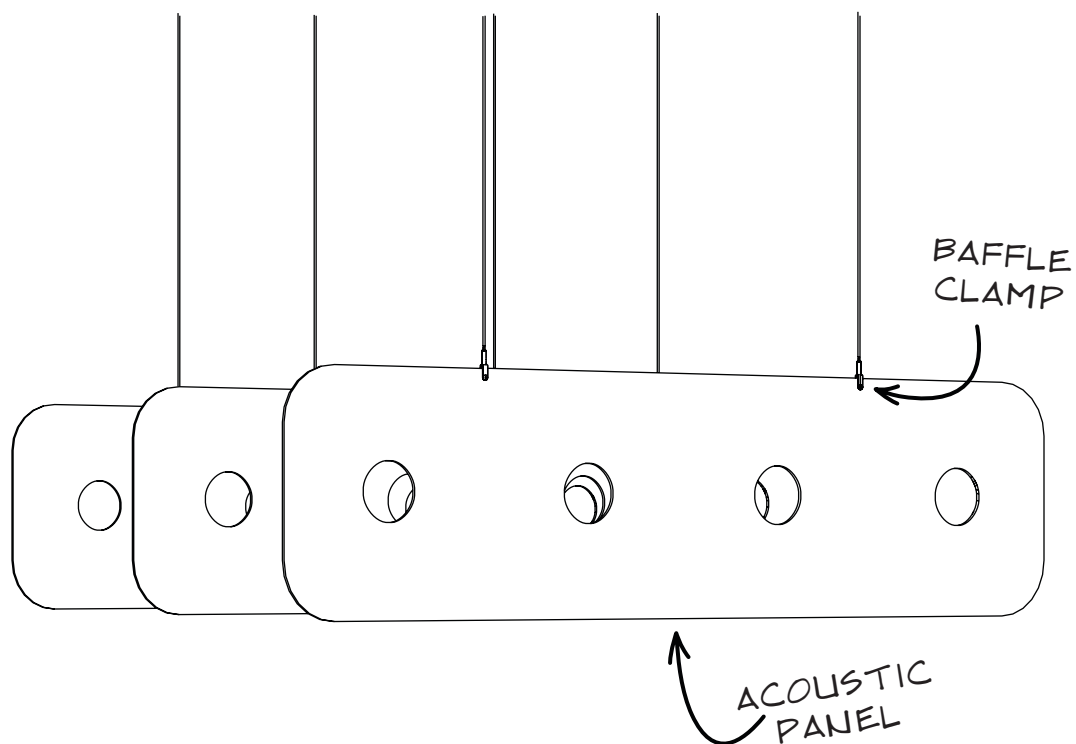

\*AVAILABLE IN TWO THICKNESSES AND FOUR MOUNTING METHODS

## Baffle Clamp Finishes



Silver

## Acoustic Panel Finishes

### ACOUSTIC PET



Brick



Pumpkin Spice



Cherry



Carrot



Sunflower



Straw



Lime



Guac



Ice

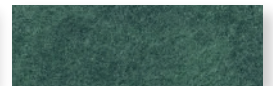

Seafoam



Peacock



Sapphire



Cobalt



Midnight



Grape



Bark



Concrete



Sand

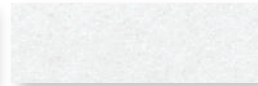

Snow



Pewter



Marble



Steel



Charcoal



Raven

## Mounting Hardware Finishes



Silver



White



Black

## Gravity Panel Cut Designs



Slab

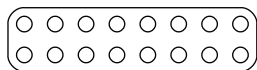

Perf

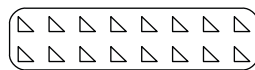

Halvsies

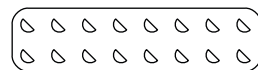

Slice

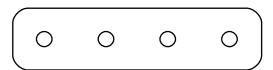

Offset

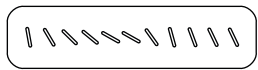

Scatter

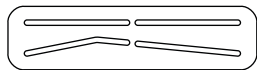

Turn

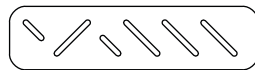

Hatch

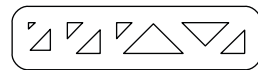

Transit



Web

# Sky Panel Cut Designs



Fractal

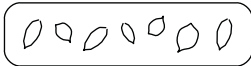

Petal

# Tempo acoustic baffle

turn down the volume, with style

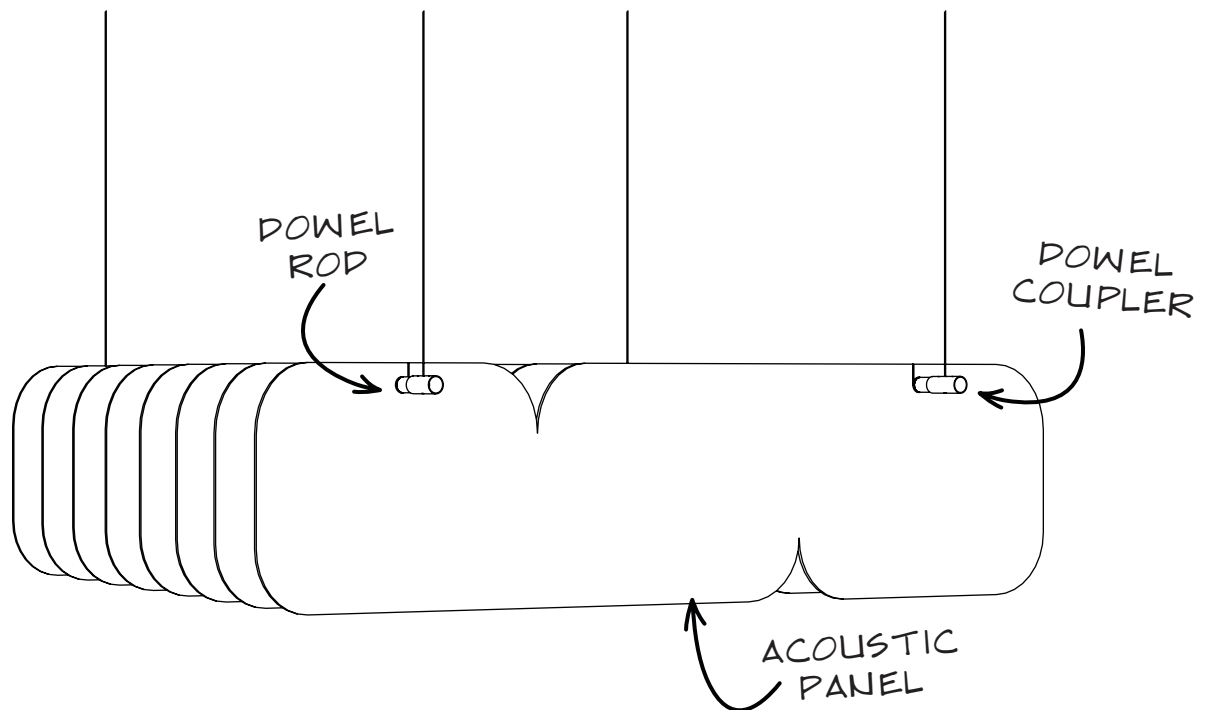

\*AVAILABLE 4' X 4' GRIDS

## Dowel Rod Finishes



White Ash



Aspen



Ebony

## Dowel Coupler Finishes



Silver

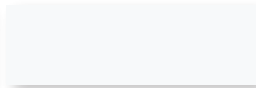

White



Black

## Acoustic Panel Finishes

### ACOUSTIC PET

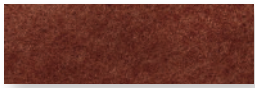

Brick



Pumpkin Spice



Cherry



Carrot



Sunflower



Straw



Lime



Guac



Ice

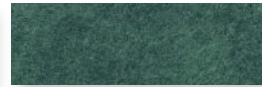

Seafoam

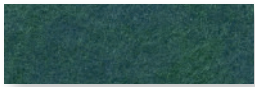

Peacock



Sapphire



Cobalt



Midnight



Grape



Bark



Concrete



Sand



Snow



Pewter



Marble



Steel



Charcoal



Raven

## Tempo Panel Designs



Turn 1



Turn 2



Turn 3



Tilt 1



Tilt 2

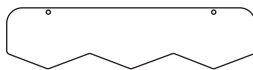

Tilt 3

# Tempo Panel Designs



Tab 1



Tab 2



Tab 3



Tide 1



Tide 2



Tide 3

# Thicc acoustic baffle

ceiling baffles that aren't on a diet

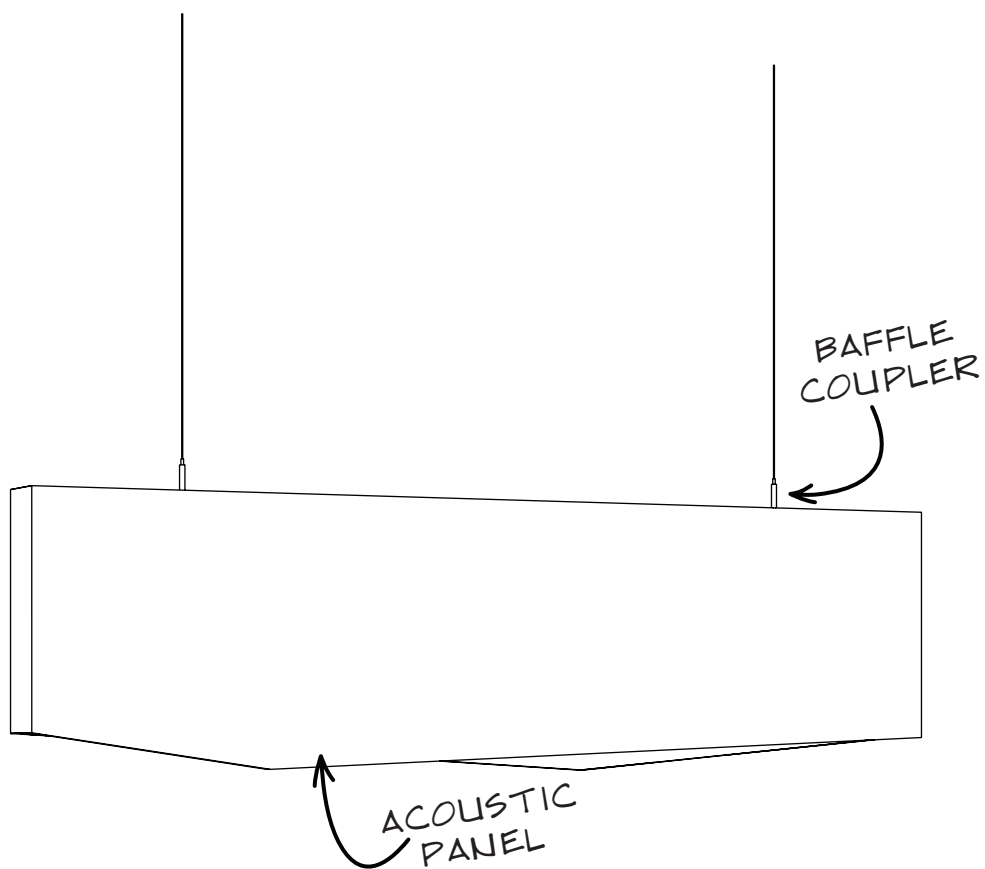

\*AVAILABLE IN THREE LENGTHS AND FOUR MOUNTING METHODS



## Baffle Coupler Finishes

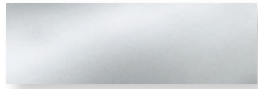

Silver

## Acoustic Panel Finishes

### ACOUSTIC PET



Brick



Pumpkin Spice



Cherry



Carrot



Sunflower



Straw



Lime



Guac



Ice

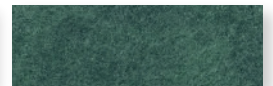

Seafoam



Peacock



Sapphire



Cobalt



Midnight



Grape



Bark



Concrete



Sand

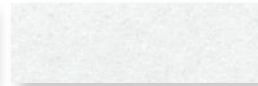

Snow



Pewter



Marble



Steel



Charcoal



Raven

## Mounting Hardware Finishes



Silver



White



Black

## Thicc Panel Designs



Base



Pitch



Wave

# Thin acoustic baffle

noise vanishes into thin air

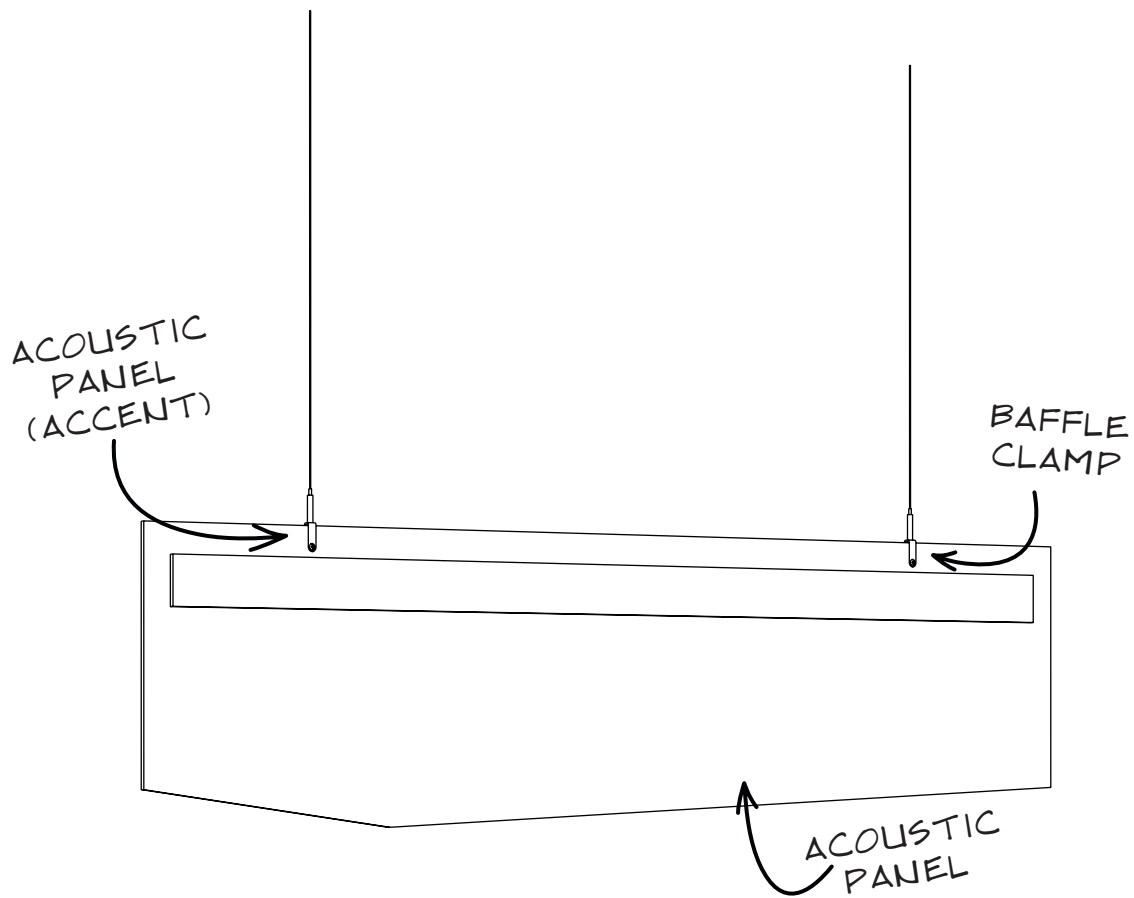

\*AVAILABLE IN THREE LENGTHS AND FOUR MOUNTING METHODS

## Baffle Clamp Finishes



Silver

## Acoustic Panel Finishes

### ACOUSTIC PET



Brick



Pumpkin Spice



Cherry



Carrot



Sunflower



Straw



Lime



Guac



Ice

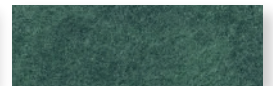

Seafoam



Peacock



Sapphire



Cobalt



Midnight



Grape



Bark



Concrete



Sand

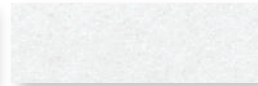

Snow



Pewter



Marble



Steel



Charcoal



Raven

## Mounting Hardware Finishes



Silver



White



Black

## Thin Panel Designs

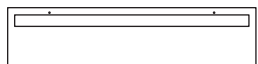

Base



Pitch

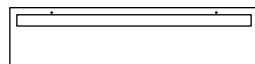

Wave

**LOFTWALL**