

LOFTWALL

2024 LIST PRICE GUIDE

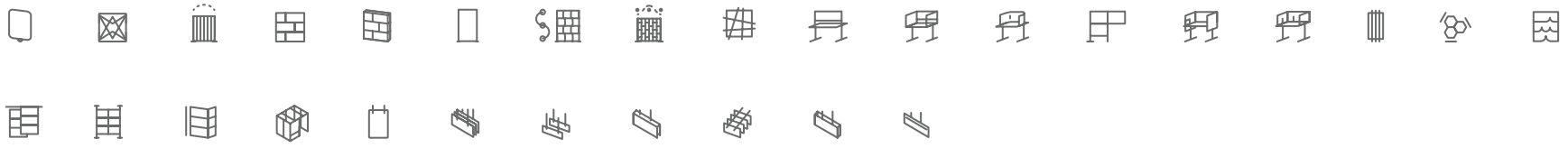



Contents

Welcome to the Loftwall price guide. Please note all displayed prices are list prices. For an industry discount, please reach out to our sales team at quotes@loftwall.com.

*All prices in USD. To convert to CAD for Canadian orders, multiply the item / total by 1.3 (subject to change at any time)

ROOM DIVIDERS

Buffer	5
Chisel.....	7
Flox.....	11
Framework.....	13
Shift.....	19
Split.....	21
Wave.....	25
Weave.....	27
Web.....	29

DESK DIVIDERS

Counter Shield.....	33
Desk Shield.....	37
Hide.....	39
Hitch.....	41
Parallel.....	45
Shelter.....	47

ACOUSTIC WALLCOVERINGS

Arbor.....	51
Tango.....	55
Tempo.....	61

ARCHITECTURAL

Glide.....	67
Hover.....	71
Pivot.....	73
Rooms.....	75

ACOUSTIC BAFFLES

Gravity.....	83
Layer.....	87
Sky.....	89
Pocket.....	91
Tempo.....	93
Thicc.....	97
Thin.....	99

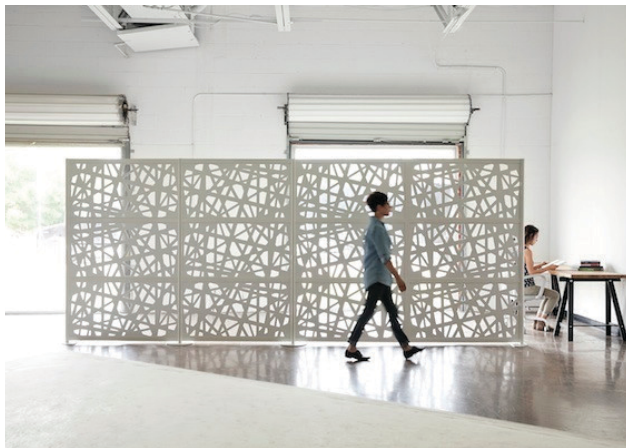

Room Dividers

Commercial-grade wall partitions for offices, hospitals, and schools. All of our room dividers are made in the USA and ship quickly.

ROOM DIVIDERS

Buffer	5
Chisel.....	7
Flox.....	11
FrameWall.....	13
Shift.....	19
Split.....	21
Wave.....	25
Weave.....	27
Web.....	29



SCAN FOR MORE VISUAL
REFERENCES OF FEATURED
PRODUCTS





Buffer room divider

Pricing

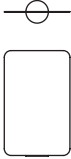

Buffer pricing is determined by a size-based SKU and quantity. While pricing varies based on quantity, all panel and base finishes are priced the same.

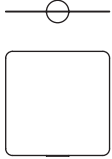
Typicals

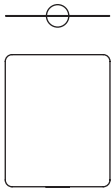
Buffer is available in 9 unique sizes. Buffer is available with a 2', 3', or 4' width and a 4', 5', or 6' height. Buffer is available in 24 9mm acoustic finishes noted as -XXX- in the product SKU.

	2' WIDE		3' WIDE		4' WIDE	
4' TALL						
	BF-4-2-XXX		BF-4-3-XXX		BF-4-4-XXX	
	Dimensions	2' W x 4' H	Dimensions	3' W x 4' H	Dimensions	4' W x 4' H
	Quantity of 1	\$1,100	Quantity of 1	\$1,190	Quantity of 1	\$1,255
	Quantity of 3	\$900 per	Quantity of 3	\$990 per	Quantity of 3	\$1,055 per
	Quantity of 5+	\$800 per	Quantity of 5+	\$890 per	Quantity of 5+	\$955 per
5' TALL						
	BF-5-2-XXX		BF-5-3-XXX		BF-5-4-XXX	
	Dimensions	2' W x 5' H	Dimensions	3' W x 5' H	Dimensions	4' W x 5' H
	Quantity of 1	\$1,170	Quantity of 1	\$1,270	Quantity of 1	\$1,350
	Quantity of 3	\$970 per	Quantity of 3	\$1,070 per	Quantity of 3	\$1,150 per
	Quantity of 5+	\$870 per	Quantity of 5+	\$970 per	Quantity of 5+	\$1,050 per

Typicals Continued

6' TALL	2' WIDE	3' WIDE	4' WIDE
			
	BF-6-2-XXX	BF-6-3-XXX	BF-6-4-XXX
	Dimensions <u>2' W x 6' H</u>	Dimensions <u>3' W x 6' H</u>	Dimensions <u>4' W x 6' H</u>
	Quantity of 1 <u>\$1,225</u>	Quantity of 1 <u>\$1,330</u>	Quantity of 1 <u>\$1,435</u>
	Quantity of 3 <u>\$1,025 per</u>	Quantity of 3 <u>\$1,130 per</u>	Quantity of 3 <u>\$1,235 per</u>
	Quantity of 5+ <u>\$925 per</u>	Quantity of 5+ <u>\$1,030 per</u>	Quantity of 5+ <u>\$1,135 per</u>

Bases

All Buffers come with a 10" circular steel base. This base is available in a variety of powder coat finishes. For a complete list of finishes, please visit loftwall.com/buffer. All base finishes are included in the price.



BP-08-XX

10" Circular Base

Price	<i>Included</i>
-------	-----------------

☒ Chisel room divider

Pricing

To price a Chisel wall, select a size-based SKU and add the price of 2 base plates and the price of each needed panel. All similar sized Chisel walls are priced the same, regardless of frame or panel finish.

Frame Typicals

Chisel is available in 12 acoustic finishes noted as -XX- in the product SKU.

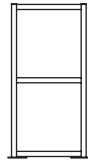

FW-XX-LH-2-3.0

Dimensions	28" W x 53" H
Panel(s)	(2) 2x2
Price	\$605



FW-XX-LH-3-3.0

Dimensions	40" W x 53" H
Panel(s)	(2) 2x3
Price	\$710

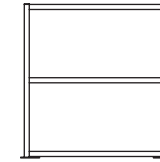

FW-XX-LH-4-3.0

Dimensions	52" W x 53" H
Panel(s)	(2) 2x4
Price	\$840

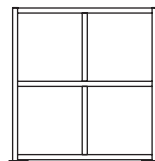

FW-XX-LH-4-3.2

Dimensions	52" W x 53" H
Panel(s)	(4) 2x2
Price	\$840

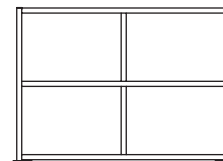

FW-XX-LH6-3.2-2

Dimensions	76" W x 53" H
Panel(s)	(4) 2x3
Price	\$1,210

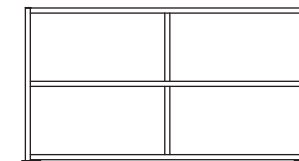

FW-XX-LH-8-3.2

Dimensions	100" W x 53" H
Panel(s)	(4) 2x4
Price	\$1,585

Frame Typicals

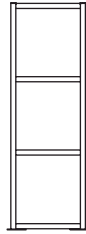

FW-XX-FH-2-4.0

Dimensions	28" W x 78" H
Panel(s)	(3) 2x2
Price	\$840

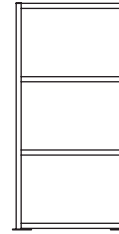

FW-XX-FH-3-4.0

Dimensions	40" W x 78" H
Panel(s)	(3) 2x3
Price	\$1,000

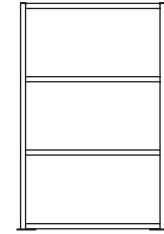

FW-XX-FH-4-4.0

Dimensions	52" W x 78" H
Panel(s)	(3) 2x4
Price	\$1,130

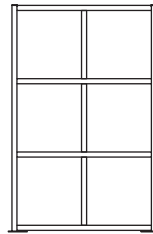

FW-XX-FH-4-4.3

Dimensions	52" W x 78" H
Panel(s)	(6) 2x2
Price	\$1,130

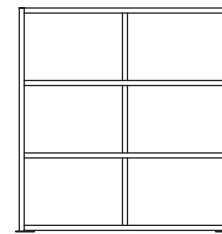

FW-XX-FH-6-4.3-2

Dimensions	76" W x 78" H
Panel(s)	(6) 2x3
Price	\$1,600



FW-XX-FH-8-4.3

Dimensions	100" W x 78" H
Panel(s)	(6) 2x4
Price	\$2,005

☒ Chisel room divider

Available Designs

Chisel panels are available in 12 standard designs. All panels are priced the same, regardless of selected design.

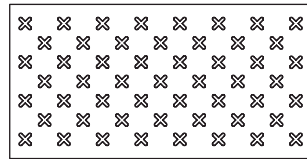

MULTIPLY

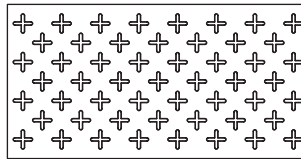

PLUS

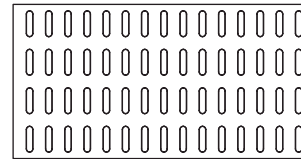

PILLS

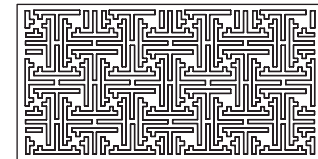

MAZE

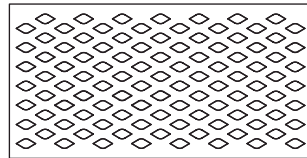

GRATE

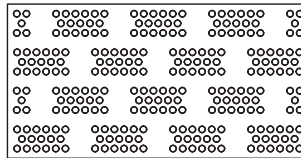

BRICK

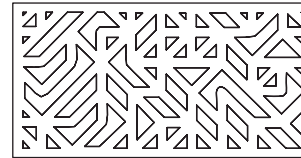

TRANSIT

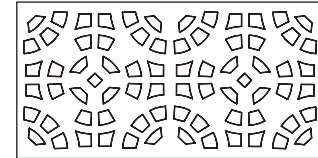

AZTEC

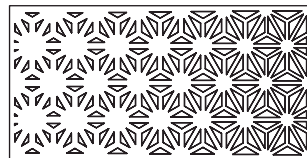

KALEIDOSCOPE

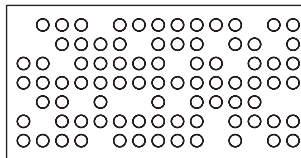

CIRCLES

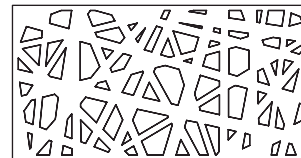

WEB

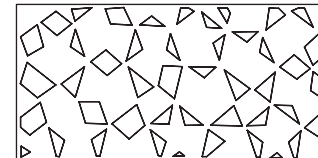

FRACTAL



Panels

Chisel panels are available in 3 different sizes, with the exception of Kaleidoscope which is only offered in 2x4. Each panel is available in a variety of finishes. For a complete list of finishes, please visit loftwall.com/chisel. All panel finishes have the same price.

Name	Description	2x2	2x3	2x4
PET felt (*PATTERN*-AKUS-*SIZE*-*COLOR*)	Sound-absorbing panel	\$120	\$175	\$235

Bases

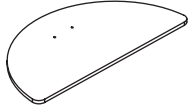
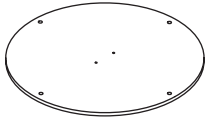
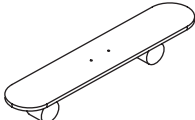
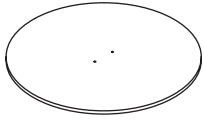
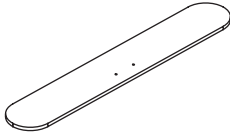
Chisel dividers are available with a variety of bases. These are available in 3 finishes: Black (BK), White (WH), and Silver (SV) noted in place of -XX- in the product SKU. All base finishes are included in the price. Bases are not included in the listed price under the typical section. Take note, -XX signifies acoustic color choice.

			
BP-01-XX 13" Half Moon	BP-02-XX 12" Floor Mount	BP-03-XX 15" Caster	BP-04-XX 12" Link
Price	\$125 per	Price	\$125 per
			
BP-05-XX 12" Flush	BP-06-XX/BP-07-XX 6" Floor/Non-Floor Mount		
Price	\$125 per	Price	\$125 per

Frame Colors

Chisel is available in 3 standard frame finishes, Black (BK), White (WH), and Silver (SV) noted in place of -XX- in the product SKU. All standard frame finishes are priced the same. Custom colors may be available upon request.

Finish	Price
Silver, White, and Black	Price included in product.
Custom Colors and Finishes	Contact us for a quote!

Flox room divider

Pricing

The below prices include all necessary hardware and panels needed for Flox. While Flox is available with 3 panel finishes and 3 frame finishes, all finishes are priced the same.

Typicals

Flox dividers can be chained together to create longer runs. Flox is available in 3 acoustic finishes noted as -XX- in the product SKU.

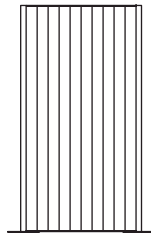

FX-XX-1

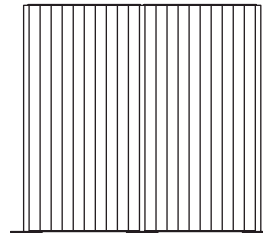

FX-XX-2

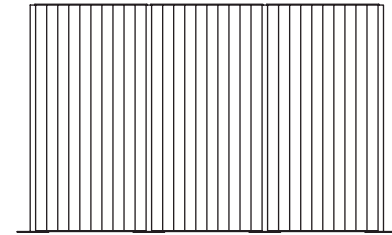

FX-XX-3

Dimensions	39" W x 73" H	Dimensions	76" W x 73" H	Dimensions	111" W x 73" H
Panel(s)	(1) Flox Panel	Panel(s)	(2) Flox Panel	Panel(s)	(3) Flox Panel
Price	\$2,140	Price	\$4,100	Price	\$6,060

Panels

Flox divider panels are available in 3 finishes. All panel finishes cost the same and have the same acoustic properties.

Panel	Description
Flox (FLOX-36-*color*)	Flexible wool

Bases

All Flox panels come with a 10" circular steel base. These are available in 3 finishes: Black (BK), White (WH), and Silver (SV) noted in place of -XX- in the product SKU. All base finishes are included in the price.

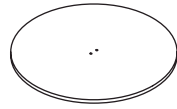

BP-08-XX

10" Circular Base

Price	<i>Included</i>
-------	-----------------

Frame Colors

Flox is available in 3 standard frame finishes, Black (BK), White (WH), and Silver (SV) noted in place of -XX- in the product SKU. All standard frame finishes are priced the same. Custom colors may be available upon request.

Finish	Price
Silver, White, and Black	Price included in product.
Custom Colors and Finishes	Contact us for a quote!

Framewall room divider

Pricing

To price Framewall, select a size-based SKU and add the price of 2 bases and preferred insert panels.

Typicals

Framewall dividers are available in 30 unique size and style based SKUs. Note each SKU comes with different panel insert requirements.

Framewall is available in 12 acoustic finishes noted as -XX- in the product SKU.



FW-XX-LH-2-3.0

Dimensions 28" W x 53" H

Panel(s) (2) 2x2

Price **\$605**

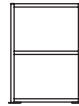

FW-XX-LH-3-3.0

Dimensions 40" W x 53" H

Panel(s) (2) 2x3

Price **\$710**

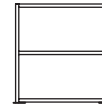

FW-XX-LH-4-3.0

Dimensions 52" W x 53" H

Panel(s) (2) 2x4

Price **\$840**

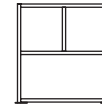

FW-XX-LH-4-3.1

Dimensions 52" W x 53" H

Panel(s) (2) 2x2
(1) 2x4

Price **\$840**

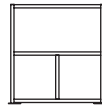

FW-XX-LH-4-3.1-2

Dimensions 52" W x 53" H

Panel(s) (2) 2x2
(1) 2x4

Price **\$840**

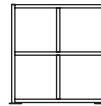

FW-XX-LH-4-3.2

Dimensions 52" W x 53" H

Panel(s) (4) 2x2

Price **\$840**

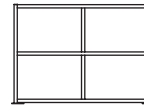

FW-XX-LH-6-3.2-2

Dimensions 76" W x 53" H

Panel(s) (4) 2x3

Price **\$1,210**

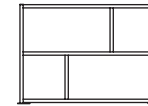

FW-XX-LH-6-3.2

Dimensions 76" W x 53" H

Panel(s) (2) 2x2
(2) 2x4

Price **\$1,210**

Typicals Continued



FW-XX-LH-6-3.3

Dimensions 76" W x 53" H

Panel(s) (4) 2x2
(1) 2x4

Price **\$1,210**

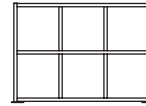

FW-XX-LH-6-3.4

Dimensions 76" W x 53" H

Panel(s) (6) 2x2

Price **\$1,210**



FW-XX-LH-8-3.2

Dimensions 100" W x 53" H

Panel(s) (4) 2x4

Price **\$1,585**



FW-XX-LH-8-3.3

Dimensions 100" W x 53" H

Panel(s) (2) 2x2
(3) 2x4

Price **\$1,585**

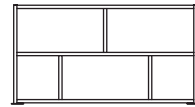

FW-XX-LH-8-3.3-2

Dimensions 100" W x 53" H

Panel(s) (2) 2x2
(3) 2x4

Price **\$1,585**

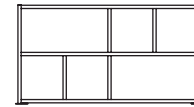

FW-XX-LH-8-3.4

Dimensions 100" W x 53" H

Panel(s) (4) 2x2
(2) 2x4

Price **\$1,585**

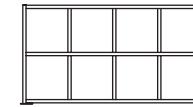

FW-XX-LH-8-3.6

Dimensions 100" W x 53" H

Panel(s) (8) 2x2

Price **\$1,585**



FW-XX-FH-2-4.0

Dimensions 28" W x 78" H

Panel(s) (3) 2x2

Price **\$840**



FW-XX-FH-3-4.0

Dimensions 40" W x 78" H

Panel(s) (3) 2x3

Price **\$1,000**

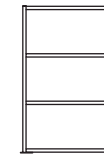

FW-XX-FH-4-4.0

Dimensions 52" W x 78" H

Panel(s) (3) 2x4

Price **\$1,130**

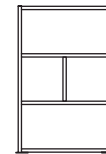

FW-XX-FH-4-4.1

Dimensions 52" W x 78" H

Panel(s) (2) 2x2
(2) 2x4

Price **\$1,130**

Framewall room divider

Typicals
Continued

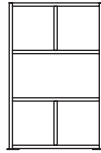

FW-XX-FH-4-4.2

Dimensions 52" W x 78" H

Panel(s) (4) 2x2
(1) 2x4

Price **\$1,130**

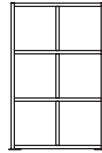

FW-XX-FH-4-4.3

Dimensions 52" W x 78" H

Panel(s) (6) 2x2

Price **\$1,130**

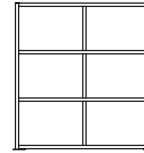

FW-XX-FH-6-4.3-2

Dimensions 76" W x 78" H

Panel(s) (6) 2x3

Price **\$1,600**

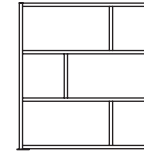

FW-XX-FH-6-4.3

Dimensions 76" W x 78" H

Panel(s) (3) 2x2
(3) 2x4

Price **\$1,600**

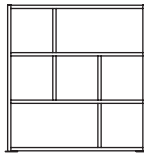

FW-XX-FH-6-4.4

Dimensions 76" W x 78" H

Panel(s) (5) 2x2
(2) 2x4

Price **\$1,600**

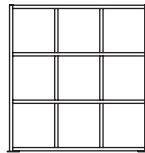

FW-XX-FH-6-4.6

Dimensions 76" W x 78" H

Panel(s) (9) 2x2

Price **\$1,600**

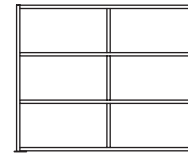

FW-XX-FH-8-4.3

Dimensions 100" W x 78" H

Panel(s) (6) 2x4

Price **\$2,005**

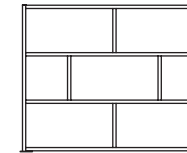

FW-XX-FH-8-4.4

Dimensions 100" W x 78" H

Panel(s) (2) 2x2
(5) 2x4

Price **\$2,005**

Typicals Continued



FW-XX-FH-8-4.5

Dimensions	100" W x 78" H
	(4) 2x2
Panel(s)	(4) 2x4
Price	\$2,005

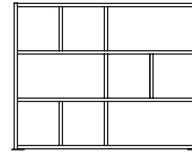

FW-XX-FH-8-4.6

Dimensions	100" W x 78" H
	(6) 2x2
Panel(s)	(3) 2x4
Price	\$2,005

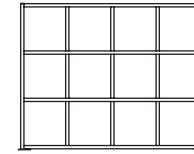

FW-XX-FH-8-4.9

Dimensions	100" W x 78" H
	(12) 2x2
Panel(s)	(12) 2x2
Price	\$2,005

Panels

Frame wall panels are available in a variety of finishes. Note: panel SKUs are identified *finish*-*size*-*color*. For a complete list of finishes, please visit loftwall.com/frame wall.

Level	Name	Description	2x2	2x3	2x4
1	PET felt (AKUS-)	Sound-absorbing panel	\$75	\$110	\$150
1	Twinwall Polycarbonate (TW-)	Translucent panel	\$75	\$110	\$150
2	Frosted or Clear Acrylic (AC-)	Translucent panel	\$120	\$175	\$235
2	Nonmagnetic Dry Erase (DEP-)	White dry erase surface	\$120	\$175	\$235
2	Cutout Composite Panel (PEG-) (WEB-)	Pegboard & Web	\$120	\$175	\$235
2	Laminates (SC-)	Woodgrain and solid finishes	\$120	\$175	\$235
2	Chisel (*PATTERN*-AKUS-)	Acoustic knife cut design panels	\$120	\$175	\$235
3	Magnetic Dry Erase (DEM-)	White dry erase surface	\$370	\$550	\$730
3	Blox Panel (BLX-)	Up to 85% sound absorption	\$370	N/A	\$730
3	Custom Artwork Panel	Custom branded panels	quote	quote	quote
3	Custom Material Panel	3Form, Lumicor, Wilsonart	quote	quote	quote

Framewall room divider

Frame Colors

Framewall is available in 3 standard frame finishes, Black (BK), White (WH), and Silver (SV) noted in place of -XX- in the product SKU. All standard frame finishes are priced the same. Custom colors may be available upon request.

Name	Description
Silver, White, and Black	Price included in product.
Custom Colors and Finishes	Contact us for a quote!

Bases

Framewall is available with a variety of bases. These are available in 3 finishes: Black (BK), White (WH), and Silver (SV) noted in place of -XX- in the product SKU. All base finishes are included in the price. Bases are not included in the listed price under the typical section.

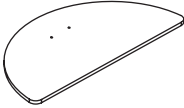
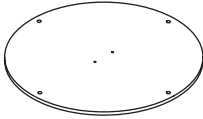
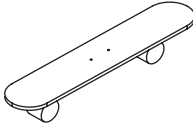
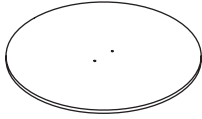
			
BP-01-XX 13" Half Moon	BP-02-XX 12" Floor Mount	BP-03-XX 15" Caster	BP-04-XX 12" Link
Price	\$125 per	Price	\$125 per
Price	\$125 per	Price	\$125 per

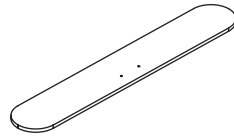

BP-05-XX

12" Flush



BP-06-XX/BP-07-XX

6" Floor/Non-Floor Mount

Price	<i>\$125 per</i>	Price	<i>\$125 per</i>
-------	------------------	-------	------------------

Shift room divider

Pricing

To price Shift, select a size-based SKU and add the price of any panel inserts. There is no price difference for shelf or frame finishes.

Typicals

Shift is available in 4 unique size-based styles. Shift is available in 3 shelf finishes noted as -XX- in the product SKU.

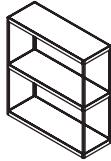
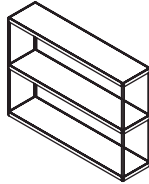
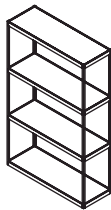
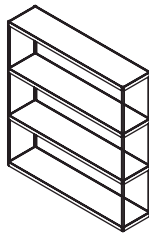
	4' WIDE	6' WIDE											
53" TALL													
	SH-XX-LH-4	SH-XX-LH-6											
	<table border="1"> <tr> <td>Dimensions</td> <td>4' W x 53" H x 17.25" D</td> </tr> <tr> <td>Description</td> <td>4' Wide, Low Height</td> </tr> <tr> <td>Price</td> <td>\$3,025</td> </tr> </table>	Dimensions	4' W x 53" H x 17.25" D	Description	4' Wide, Low Height	Price	\$3,025	<table border="1"> <tr> <td>Dimensions</td> <td>6' W x 53" H x 17.25" D</td> </tr> <tr> <td>Description</td> <td>6' Wide, Low Height</td> </tr> <tr> <td>Price</td> <td>\$4,235</td> </tr> </table>	Dimensions	6' W x 53" H x 17.25" D	Description	6' Wide, Low Height	Price
Dimensions	4' W x 53" H x 17.25" D												
Description	4' Wide, Low Height												
Price	\$3,025												
Dimensions	6' W x 53" H x 17.25" D												
Description	6' Wide, Low Height												
Price	\$4,235												
78" TALL													
	SH-XX-FH-4	SH-XX-FH-6											
	<table border="1"> <tr> <td>Dimensions</td> <td>4' W x 78" H x 17.25" D</td> </tr> <tr> <td>Description</td> <td>4' Wide, Full Height</td> </tr> <tr> <td>Price</td> <td>\$3,630</td> </tr> </table>	Dimensions	4' W x 78" H x 17.25" D	Description	4' Wide, Full Height	Price	\$3,630	<table border="1"> <tr> <td>Dimensions</td> <td>6' W x 78" H x 17.25" D</td> </tr> <tr> <td>Description</td> <td>6' Wide, Full Height</td> </tr> <tr> <td>Price</td> <td>\$4,840</td> </tr> </table>	Dimensions	6' W x 78" H x 17.25" D	Description	6' Wide, Full Height	Price
Dimensions	4' W x 78" H x 17.25" D												
Description	4' Wide, Full Height												
Price	\$3,630												
Dimensions	6' W x 78" H x 17.25" D												
Description	6' Wide, Full Height												
Price	\$4,840												

Panels

Shift can be outfitted with a variety of infill panels. While not necessary, these panels elevate the design and function of Shift. Small panels are 2'x2' while large panels are 2'x4'. Note: panel SKUs are identified *finish*-*size*-*color*.

Level	Name	Description	2x2	2x3	2x4
1	PET felt (AKUS-)	Sound-absorbing panel	\$75	\$110	\$150
1	Twinwall Polycarbonate (TW-)	Translucent panel	\$75	\$110	\$150
2	Frosted or Clear Acrylic (AC-)	Translucent panel	\$120	\$175	\$235
2	Nonmagnetic Dry Erase (DEP-)	White dry erase surface	\$120	\$175	\$235
2	Cutout Composite Panel (PEG-) (WEB-)	Pegboard & Web	\$120	\$175	\$235
2	Laminates (SC-)	Woodgrain and solid finishes	\$120	\$175	\$235
2	Chisel (*PATTERN*-AKUS-)	Acoustic knife cut design panels	\$120	\$175	\$235
3	Magnetic Dry Erase (DEM-)	White dry erase surface	\$370	\$550	\$730
3	Blox Panel (BLX-)	Up to 85% sound absorption	\$370	N/A	\$730
3	Custom Artwork Panel	Custom branded panels	quote	quote	quote
3	Custom Material Panel	3Form, Lumicor, Wilsonart	quote	quote	quote

Frame Colors

Shift are available in 3 standard frame finishes. All standard frame finishes are priced the same. Custom colors may be available upon request.

Name	Description
Silver, White, and Black	Price included in product.
Custom Colors and Finishes	Contact us for a quote!

□ Split room divider

Pricing

To price Split, select a size-based SKU and add the price of 2 base plates and the price of each panel needed.

Typicals

Split is available in 8 unique size-based styles. Split is available in 3 frame finishes noted by the first set of -XX- and 12 acoustic finishes noted as the second set of -XX- in the product SKU.

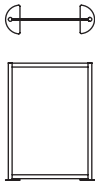
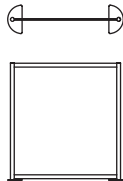
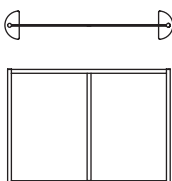
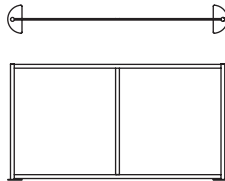
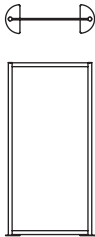
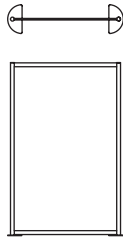
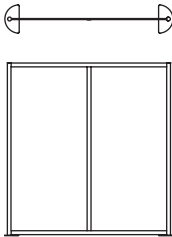
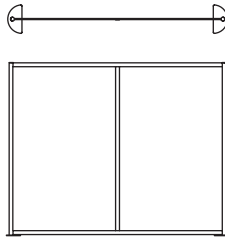
	40" WIDE	52" WIDE	76" WIDE	100" WIDE
53" TALL				
	SP-XX-LH-3	SP-XX-LH-4	SP-XX-LH-6	SP-XX-LH-8
	Panel(s) (1) 40"	Panel(s) (1) 52"	Panel(s) (2) 40"	Panel(s) (2) 52"
	Level 1 \$1,175	Level 1 \$1,295	Level 1 \$1,970	Level 1 \$2,085
	Level 2 \$1,270	Level 2 \$1,430	Level 2 \$2,160	Level 2 \$2,355
78" TALL				
	SP-XX-FH-3	SP-XX-FH-4	SP-XX-FH-6	SP-XX-FH-8
	Panel(s) (1) 40"	Panel(s) (1) 52"	Panel(s) (2) 40"	Panel(s) (2) 52"
	Level 1 \$1,485	Level 1 \$1,550	Level 1 \$2,550	Level 1 \$2,640
	Level 2 \$1,640	Level 2 \$1,770	Level 2 \$2,860	Level 2 \$3,080

Panels

Split panels are available in a variety of finishes.

Level	Name	Description
1	PET felt (AKUS-)	Sound-absorbing panel
1	Twinwall Polycarbonate (TW-)	Translucent panel
2	Frosted or Clear Acrylic (AC-)	Translucent panel
2	Nonmagnetic Dry Erase (DEP-)	White dry erase surface
2	Laminates (SC-)	Woodgrain and solid finishes

Frame Colors

Split is available in 3 standard frame finishes, Black (BK), White (WH), and Silver (SV) noted in place of -XX- in the product SKU. All standard frame finishes are priced the same. Custom colors may be available upon request.

Name	Description
Silver, White, and Black	Price included in product.
Custom Colors and Finishes	Contact us for a quote!

Bases

Split is available with a variety of bases. These are available in 3 finishes: Black (BK), White (WH), and Silver (SV) noted in place of -XX- in the product SKU. All base finishes are included in the price. Bases are not included in the listed price under the typical section.

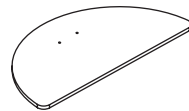

BP-01-XX
13" Half Moon

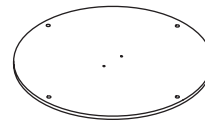

BP-02-XX
12" Floor Mount

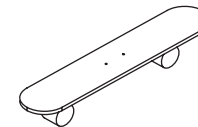

BP-03-XX
15" Caster

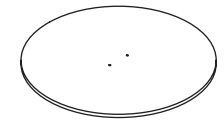

BP-04-XX
12" Link

Price	\$125 per	Price	\$125 per	Price	\$125 per	Price	\$125 per
-------	------------------	-------	------------------	-------	------------------	-------	------------------

□ Split room divider

Bases
Continued

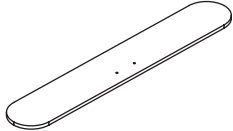

BP-05-XX
12" Flush



BP-06-XX/BP-07-XX
6" Floor/Non-Floor Mount

Price	\$125 per	Price	\$125 per
-------	------------------	-------	------------------



\$ **Wave** room divider

Pricing

To price Wave, select a size-based SKU and add the price of 2 base plates. Frame color and panel inserts do no impact the price of the Wave.

Typicals

Wave is available in 3 unique size-based styles. Wave is available in 3 finishes noted as -XX- in the product SKU.

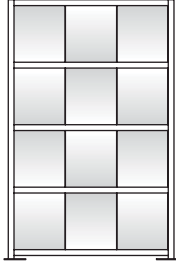
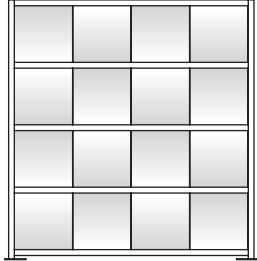
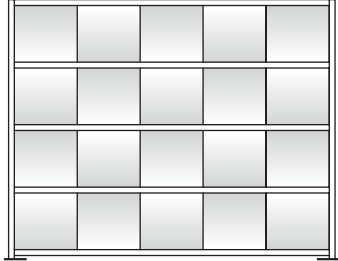
	52" WIDE	76" WIDE	100" WIDE
			
			
78" TALL			
	WW-SM-XX	WW-MD-XX	WW-LG-XX
Dimensions	53" W x 78" H	Dimensions 76" W x 78" H	Dimensions 100" W x 78" H
Panels	(12) HDPE Panels	Panels (16) HDPE Panels	Panels (20) HDPE Panels
Price	\$1,650	Price \$2,375	Price \$3,025

Panels

Wave divider panels are in 3 standard finishes. All panel finishes are priced the same.

Panel	Description	Colors
HDPE (CS-)	Undulating Panel	White, Black, Gray

Frame Colors

Split is available in 3 standard frame finishes, Black (BK), White (WH), and Silver (SV) noted in place of -XX- in the product SKU. All standard frame finishes are priced the same. Custom colors may be available upon request.

Finish	Price
Silver, White, and Black	Price included in product.
Custom Colors and Finishes	Contact us for a quote!

Bases

Wave is available with a variety of bases. These are available in 3 finishes: Black (BK), White (WH), and Silver (SV) noted in place of -XX- in the product SKU. All base finishes are included in the price. Bases are not included in the listed price under the typical section.

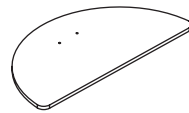

BP-01-XX
13" Half Moon

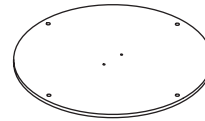

BP-02-XX
12" Floor Mount

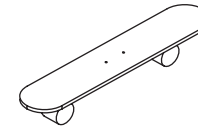

BP-03-XX
15" Caster

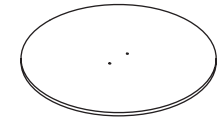

BP-04-XX
12" Link

Price	\$125 per	Price	\$125 per	Price	\$125 per	Price	\$125 per
-------	------------------	-------	------------------	-------	------------------	-------	------------------

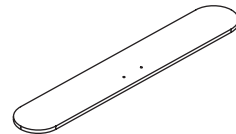

BP-05-XX
12" Flush



BP-06-XX/BP-07-XX
6" Floor/Non-Floor Mount

Price	\$125 per	Price	\$125 per
-------	------------------	-------	------------------





Weave room divider

Pricing

To price Weave, select a size-based SKU and add the price of two base plates. Frame color and panel inserts do no impact the price.

Typicals

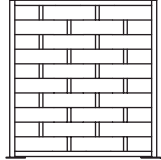
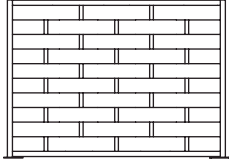
Weave is available in 4 unique size-based styles. Weave is available in 12 acoustic finishes noted as -XX- in the product SKU.

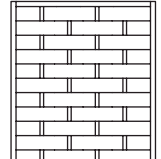
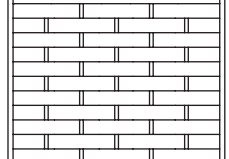
	52" WIDE	76" WIDE											
53" TALL													
													
	WE-XX-LH-4	WE-XX-LH-6											
	<table border="1"> <tr> <td>Dimensions</td> <td>52" W x 53" H</td> </tr> <tr> <td>Panels</td> <td>(10) Weave Panels</td> </tr> <tr> <td>Price</td> <td>\$1,255</td> </tr> </table>	Dimensions	52" W x 53" H	Panels	(10) Weave Panels	Price	\$1,255	<table border="1"> <tr> <td>Dimensions</td> <td>76" W x 53" H</td> </tr> <tr> <td>Panels</td> <td>(10) Weave Panels</td> </tr> <tr> <td>Price</td> <td>\$1,820</td> </tr> </table>	Dimensions	76" W x 53" H	Panels	(10) Weave Panels	Price
Dimensions	52" W x 53" H												
Panels	(10) Weave Panels												
Price	\$1,255												
Dimensions	76" W x 53" H												
Panels	(10) Weave Panels												
Price	\$1,820												
78" TALL													
													
	WE-XX-FH-4	WE-XX-FH-6											
	<table border="1"> <tr> <td>Dimensions</td> <td>52" W x 78" H</td> </tr> <tr> <td>Panels</td> <td>(15) Weave Panels</td> </tr> <tr> <td>Price</td> <td>\$1,735</td> </tr> </table>	Dimensions	52" W x 78" H	Panels	(15) Weave Panels	Price	\$1,735	<table border="1"> <tr> <td>Dimensions</td> <td>76" W x 78" H</td> </tr> <tr> <td>Panels</td> <td>(15) Weave Panels</td> </tr> <tr> <td>Price</td> <td>\$2,495</td> </tr> </table>	Dimensions	76" W x 78" H	Panels	(15) Weave Panels	Price
Dimensions	52" W x 78" H												
Panels	(15) Weave Panels												
Price	\$1,735												
Dimensions	76" W x 78" H												
Panels	(15) Weave Panels												
Price	\$2,495												

Panels

Weave divider panels are available in a variety of acoustic felt finishes. For a complete list of finishes, please visit loftwall.com/weave. All panel finishes are included in the price of Weave.

Name	Description
PET felt (AKUS-WEAVE-*SIZE*-*COLOR*)	Sound-absorbing panel

Frame Colors

Weave is available in 3 standard frame finishes, Black (BK), White (WH), and Silver (SV) noted in place of -XX- in the product SKU. All standard frame finishes are priced the same. Custom colors may be available upon request.

Finish	Price
Silver, White, and Black	Price included in product.
Custom Colors and Finishes	Contact us for a quote!

Bases

Weave is available with a variety of bases. These are available in 3 finishes: Black (BK), White (WH), and Silver (SV) noted in place of -XX- in the product SKU. All base finishes are included in the price. Bases are not included in the listed price under the typical section.

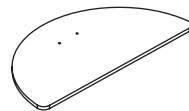

BP-01-XX

13" Half Moon

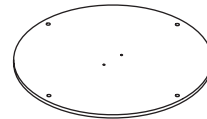

BP-02-XX

12" Floor Mount

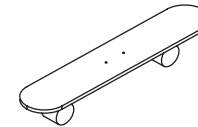

BP-03-XX

15" Caster



BP-04-XX

12" Link

Price	\$125 per	Price	\$125 per	Price	\$125 per	Price	\$125 per
-------	------------------	-------	------------------	-------	------------------	-------	------------------

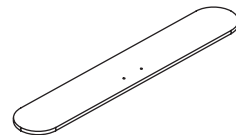

BP-05-XX

12" Flush



BP-06-XX/BP-07-XX

6" Floor/Non-Floor Mount

Price	\$125 per	Price	\$125 per
-------	------------------	-------	------------------

Web room divider

Pricing

To price Web, select a size-based SKU and add the price of 2 base plates and the price of each needed panel. Frame color and panel inserts do no impact the price of Web.

Typicals

Web is available in 6 unique size-based styles. Web is available in 3 finishes noted as -XX- in the product SKU.

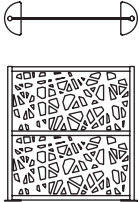
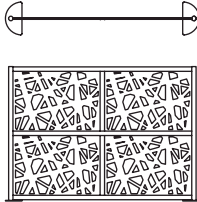
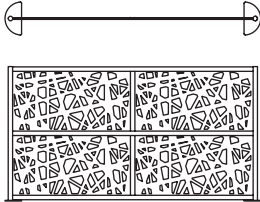
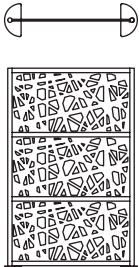
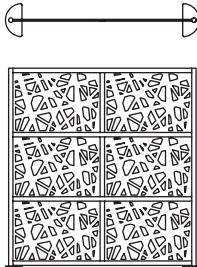
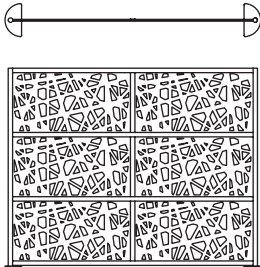
	52" WIDE	76" WIDE	100" WIDE
53" TALL			
	FW-XX-LH-4-3.0	FW-XX-LH-6-3.22	FW-XX-LH-8-3.2
	Dimensions 52" W x 53" H	Dimensions 76" W x 53" H	Dimensions 100" W x 53" H
	Panels 2x4	Panels (4) 2x3	Panels (4) 2x4
	Price \$840	Price \$1,210	Price \$1,585
78" TALL			
	FW-XX-FH-4-4.0	FW-XX-FH-6-4.3-2	FW-XX-FH-8-4.3
	Dimensions 52" W x 78" H	Dimensions 76" W x 78" H	Dimensions 100" W x 78" H
	Panels (3) 2x4	Panels (6) 2x3	Panels (6) 2x4
	Price \$1,130	Price \$1,600	Price \$2,005

Panels

Web divider panels are in 3 standard finishes. All panel finishes are priced the same.

Name	Description	2x2	2x3	2x4
HDPE (CS-*SIZE*-WEB-*COLOR*)	Knife cut design panel	\$120	\$245	\$325

Frame Colors

Weave is available in 3 standard frame finishes, Black (BK), White (WH), and Silver (SV) noted in place of -XX- in the product SKU. All standard frame finishes are priced the same. Custom colors may be available upon request.

Finish	Price
Silver, White, and Black	Price included in product.
Custom Colors and Finishes	Contact us for a quote!

Bases

Web is available with a variety of bases. These are available in 3 finishes: Black (BK), White (WH), and Silver (SV) noted in place of -XX- in the product SKU. All base finishes are included in the price. Bases are not included in the listed price under the typical section.

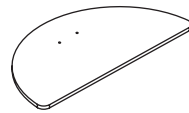

BP-01-XX
13" Half Moon

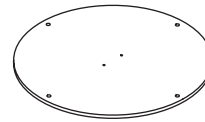

BP-02-XX
12" Floor Mount

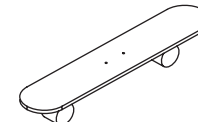

BP-03-XX
15" Caster

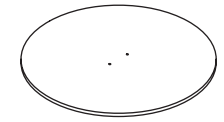

BP-04-XX
12" Link

Price	\$125 per	Price	\$125 per	Price	\$125 per	Price	\$125 per
-------	------------------	-------	------------------	-------	------------------	-------	------------------

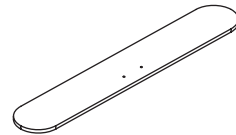

BP-05-XX
12" Flush



BP-06-XX/BP-07-XX
6" Floor/Non-Floor Mount

Price	\$125 per	Price	\$125 per
-------	------------------	-------	------------------

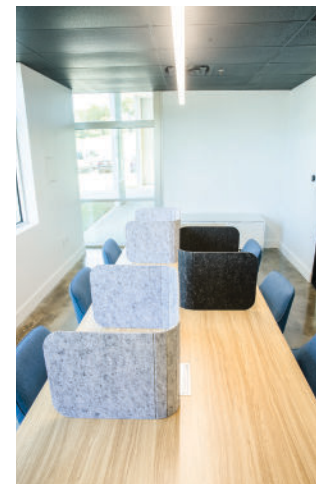
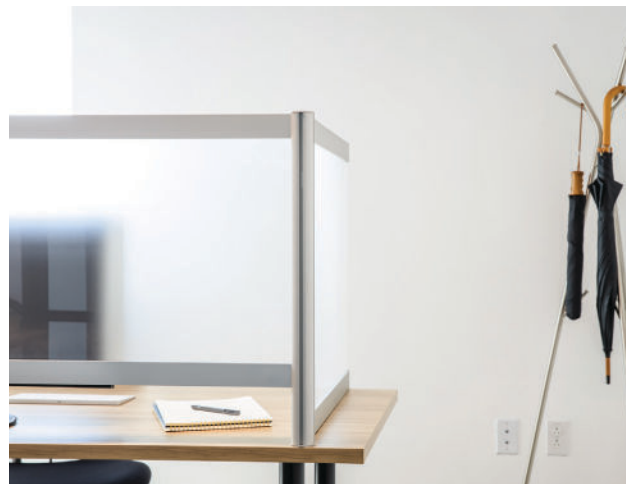

Desk Dividers

Freestanding and clamp-on desk dividers for offices, hospitals, and schools. Available with acoustic felt, plexiglass, or dry-erase finishes. All desk privacy panels are made in the USA and ship quickly.

DESK DIVIDERS

Counter Shield.....	33
Desk Shield.....	37
Hide.....	39
Hitch.....	41
Parallel.....	45
Shelter.....	47



SCAN FOR MORE VISUAL
REFERENCES OF FEATURED
PRODUCTS

Counter Shield desk divider

Pricing

To price Counter Shield, select a style and size. All Counter Shields are available with clear or frosted panels. Both panels are priced the same. Frame color, bases and panel inserts do not impact the price of the Counter Shield.

Typicals

Counter Shields are available in 4 standard styles: Lite, Basic, Classic, and Wrap. SKUs with the "-NP" suffix have no pass through window.

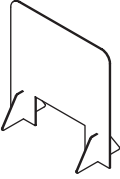
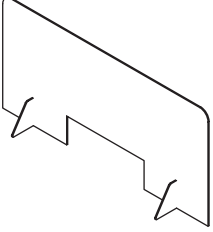
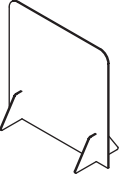
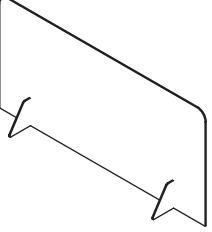
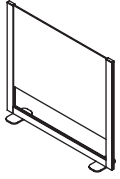
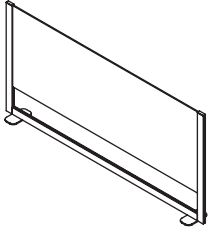
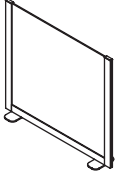
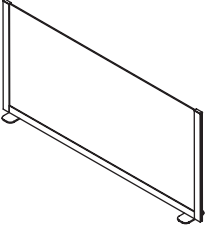
LITE				
	CS-SM-LITE	CS-LG-LITE	CS-SM-LITE-NP	CS-LG-LITE-NP
	Dimensions 24" W x 24" H	Dimensions 48" W x 24" H	Dimensions 24" W x 24" H	Dimensions 48" W x 24" H
	Price \$215	Price \$420	Price \$215	Price \$420
BASIC				
	CS-XX-SM-BASC	CS-XX-LG-BASC	CS-XX-SM-BASC-NP	CS-XX-LG-BASC-NP
	Dimensions 32" W x 28" H	Dimensions 59" W x 28" H	Dimensions 32" W x 28" H	Dimensions 59" W x 28" H
	Price \$395	Price \$705	Price \$395	Price \$705

Typicals Continued

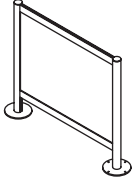
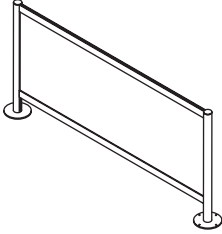
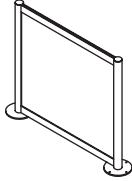
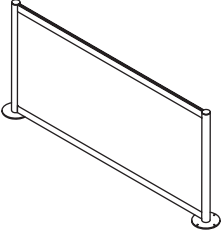
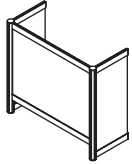
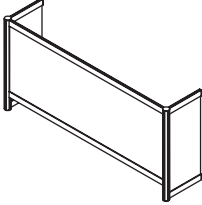
CLASSIC				
	CS-XX-SM-CLSC	CS-XX-LG-CLSC	CS-XX-SM-CLSC-NP	CS-XX-LG-CLSC-NP
	Dimensions 36" W x 28" H	Dimensions 63" W x 28" H	Dimensions 36" W x 28" H	Dimensions 63" W x 28" H
	Price \$540	Price \$900	Price \$540	Price \$900
WRAP				
	CS-XX-SM-WRAP	CS-XX-LG-WRAP		
	Dimensions 32" W x 28" H	Dimensions 59" W x 28" H		
Price \$640	Price \$1,045			

Frame Colors

Basic, Classic and Wrap Counter Shields are available in 3 standard frame finishes, Black (BK), White (WH), and Silver (SV) noted in place of -XX- in the product SKU. All standard frame finishes are priced the same. Custom colors may be available upon request.

Finish	Price
Silver, White, and Black	Price included in product.
Custom Colors and Finishes	Contact us for a quote!

Counter Shield desk divider

Panels

All Counter Shields use acrylic insert panels. Panels may be clear or frosted. Both panels are priced the same.

Name	Description	Price
Frosted or Clear Acrylic (AC-*SIZE*-*CL/FC*)	Translucent panel	Price included in product.

Bases

Counter Shield is available with one base option. The base is available in 3 finishes: Black (BK), White (WH), and Silver (SV) noted in place of -XX- in the product SKU. All base finishes are included in the price. Bases are included in the listed price under the typical section.



BP-06-XX/BP-07-XX

6" Floor/Non-Floor Mount

Price *Included*

Desk Shield desk divider

Pricing

To price Desk Shield, select a size-based SKU. Frame color and panel inserts do no impact the price of the Desk Shield.

Typicals

Desk Shield is available in 6 unique size-based styles. Desk Shield is available in 2 panel finishes noted as -XX- in the product SKU.

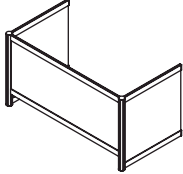
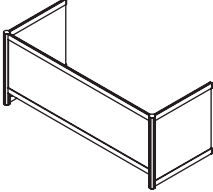
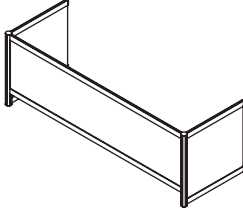
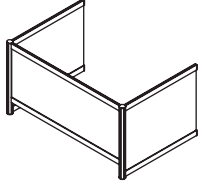
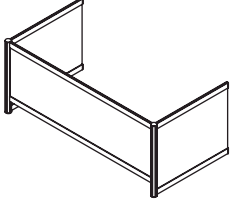
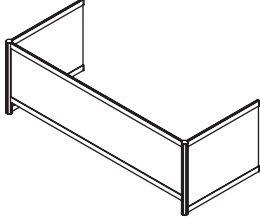
	48" WIDE	60" WIDE	72" WIDE
24" DEPTH			
	DS-XX-48-24	DS-XX-60-24	DS-XX-72-24
	Dimensions 48" W x 24" H x 24" D	Dimensions 60" W x 24" H x 24" D	Dimensions 72" W x 24" H x 24" D
	Panels (3) Panels	Panels (3) Panels	Panels (3) Panels
	Price \$1,365	Price \$1,595	Price \$1,705
30" DEPTH			
	DS-XX-48-30	DS-XX-60-30	DS-XX-72-30
	Dimensions 48" W x 24" H x 30" D	Dimensions 60" W x 24" H x 30" D	Dimensions 72" W x 24" H x 30" D
	Panels (3) Panels	Panels (3) Panels	Panels (3) Panels
	Price \$1,475	Price \$1,715	Price \$1,830

Panels

Desk Shield is available with clear or frosted acrylic panel inserts. Panel inserts are already included in the listed SKU price.

Name	Description
Frosted or Clear Acrylic (AC-*SIZE*-*CL/FC*)	Translucent panel

Frame Colors

Desk Shield is available in 3 standard frame finishes, Black (BK), White (WH), and Silver (SV) noted in place of -XX- in the product SKU. All standard frame finishes are priced the same. Custom colors may be available upon request.

Finish	Price
Silver, White, and Black	Price included in product.
Custom Colors and Finishes	Contact us for a quote!

Hide desk divider

Pricing

All hides are priced the same, regardless of selected acoustic felt finish.

Typicals

Hide is available in 1 size, with 24 9mm acoustic finishes noted as -XX- in the product SKU. Custom colors may be available upon request.

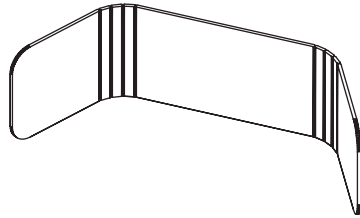

LW-HIDE-XX

63.25" W x 15" H

\$130

Panels

Hide is available in a variety of acoustic felt finishes. For a complete list of finishes, please visit loftwall.com/hide

Name	Description
PET felt (PATTERN-AKUS-64/84-FINISH)	Sound-absorbing panel

Hitch desk divider

Pricing

All Hitch dividers are priced based on their size-based SKU. Frame color, bases and panel inserts do no impact the price of the Hitch.

Typicals

Hitch dividers are available in 6 size-based styles. Hitch is available in 6 finishes noted as -XX- in the product SKU.

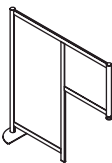
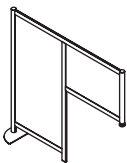
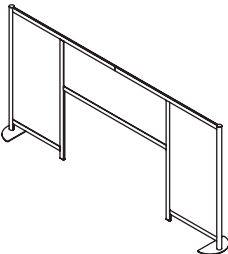
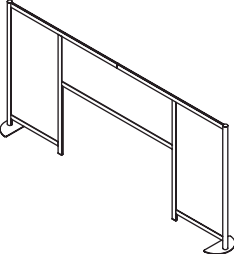
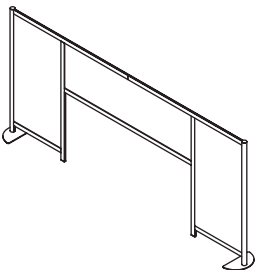
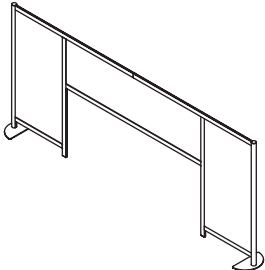
SINGLE				
	<p>HT-XX-24-NG</p> <p>Dimensions 51" W x 53" H</p> <hr/> <p>(1) 2X4 Panels</p> <p>Panels (1) 24" Desk</p> <hr/> <p>Price \$1,010</p>	<p>HT-XX-30-SNG</p> <p>Dimensions 57" W x 53" H</p> <hr/> <p>(1) 2X4 Panels</p> <p>Panels (1) 30" Desk</p> <hr/> <p>Price \$1,180</p>		
DOUBLE				
	<p>HT-XX-51-DBL</p> <p>Dimensions 108" W x 53" H</p> <hr/> <p>(2) 2X4 Panels</p> <p>Panels (1) 51" Double</p> <hr/> <p>Price \$2,025</p>	<p>HT-XX-55-DBL</p> <p>Dimensions 112" W x 53" H</p> <hr/> <p>(2) 2X4 Panels</p> <p>Panels (1) 55" Double</p> <hr/> <p>Price \$2,250</p>	<p>HT-XX-63-DBL</p> <p>Dimensions 120" W x 53" H</p> <hr/> <p>(2) 2X4 Panels</p> <p>Panels (1) 63" Double</p> <hr/> <p>Price \$2,475</p>	<p>HT-XX-67-DBL</p> <p>Dimensions 124" W x 53" H</p> <hr/> <p>(2) 2X4 Panels</p> <p>Panels (1) 67" Double</p> <hr/> <p>Price \$2,700</p>

Panels

Hitch panels are available in a variety of finishes. For Hitch, all panels are priced the same.

Name	Description
PET felt (AKUS-)	Sound-absorbing panel
Twinwall Polycarbonate (TW-)	Translucent panel
Frosted or Clear Acrylic (AC-)	Translucent panel
Nonmagnetic Dry Erase (DEP-)	White dry erase surface
Cutout Composite Panel (PEG-) (WEB-)	Pegboard & Web
Laminates (SC-)	Woodgrain and solid finishes
Magnetic Dry Erase (DEM-)	White dry erase surface
Blox Panel (BLX-)	Up to 85% sound absorption
Custom Artwork Panel	Custom branded panels
Custom Material Panel	3Form, Lumicor, Wilsonart

Frame Colors

Hitch is available in 3 standard frame finishes, Black (BK), White (WH), and Silver (SV) noted in place of -XX- in the product SKU. All standard frame finishes are priced the same. Custom colors may be available upon request.

Name	Price
Silver, White, and Black	Price included in product.
Custom Colors and Finishes	Contact us for a quote!

Hitch desk divider

Bases

Hitch only offers one base option available in 3 finishes: Black (BK), White (WH), and Silver (SV) noted in place of -XX- in the product SKU. All base finishes are included in the price. Bases are not included in the listed price under the typical section.

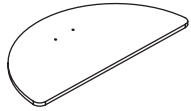

BP-01-XX

13" Half Moon

Price

Included

Parallel desk divider

Pricing

To price Parallel, select a style, size, and finish. All Parallel panels come with the necessary install hardware.

Typicals

Parallel panels are available in 8 standard sizes. Side-to-side panels are available in 1 width, 2 heights. Modesty panels are available in 3 widths, 2 heights. Parallel is available in 24 finishes noted as -XX- in the product SKU.

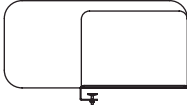
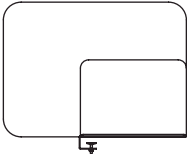
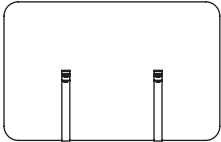
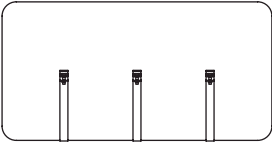
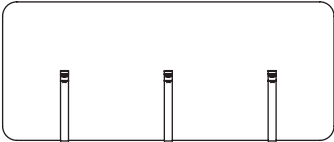
	SIDE-TO-SIDE		MODESTY PANEL							
										
	PA-WH-LF/RT-15H S-PAR-XX-SIZE-XX	PA-WH-LF/RT-24H S-PAR-XX-SIZE-XX	PA-WH-MOD-15H-48W	PA-WH-MOD-15H-60W	PA-WH-MOD-15H-72W					
	Dimensions	30" W x 15" H	Dimensions	46" W x 30" H	Dimensions	57" W x 30" H	Dimensions	70" W x 30" H		
	Acoustic PET panel	\$415	Acoustic PET panel	\$450	Acoustic PET panel	\$660	Acoustic PET panel	\$850	Acoustic PET panel	\$1,015

Typicals Continued

MODESTY PANEL

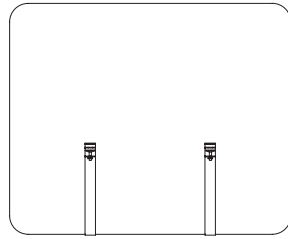

PA-WH-MOD-24H-48W

Dimensions 46" W x 39" H

Acoustic PET panel **\$760**

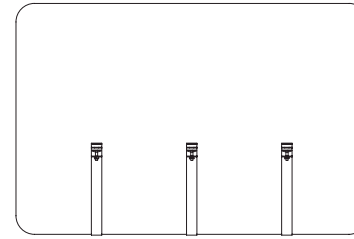

PA-WH-MOD-24H-60W

Dimensions 57" W x 39" H

Acoustic PET panel **\$935**

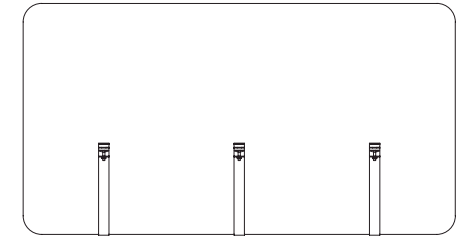

PA-WH-MOD-24H-72W

Dimensions 70" W x 39" H

Acoustic PET panel **\$1,100**

Hardware

All Parallel panels come with the necessary install hardware at no additional cost.

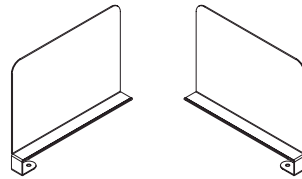

SIDE DEVICE ORGANIZER

18" W x 13" H x 3" D



MODESTY BRACKET

1.75" W x 15" H x 4.25" D

Panels

All Parallel panels are built with two 3/8" acoustic PET panels adhered to each other. The Parallel panel can be either monotone or duo tone at no additional charge. For a complete list of available finishes, please visit loftwall.com/parallel.

Name	Description
Acoustic PET	Sound-absorbing panel

Shelter desk divider

Pricing

To price Shelter, select a sized-based SKU and a panel material.

Side-to-Side Typicals

Shelter is available in 5 unique size-based styles. Shelter offers 24 9mm acoustic finishes noted as -XX- in the product SKU.

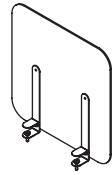

ST-XX-STD-24

Dimensions 24" W x 24" H

PET **\$310**

Acrylic **\$470**

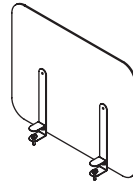

ST-XX-STD-30

Dimensions 30" W x 24" H

PET **\$355**

Acrylic **\$510**

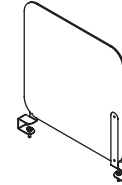

ST-XX-FNT-24

Dimensions 24" W x 24" H

PET **\$310**

Acrylic **\$470**

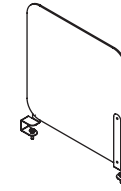

ST-XX-FNT-30

Dimensions 30" W x 24" H

PET **\$355**

Acrylic **\$510**

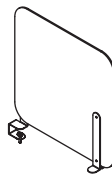

ST-XX-FNT-FREE-24

Dimensions 24" W x 24" H

PET **\$310**

Acrylic **\$470**

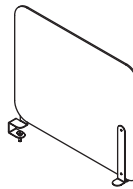

ST-XX-FNT-FREE-30

Dimensions 30" W x 24" H

PET **\$355**

Acrylic **\$510**

Back Panel Typicals

BACK PANEL

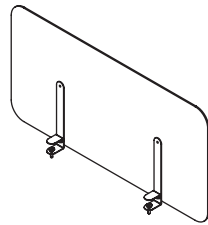

ST-XX-STD-48

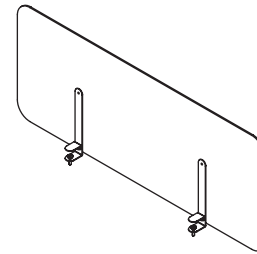

ST-XX-STD-60

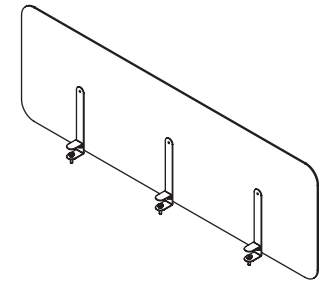

ST-XX-STD-72

Dimensions	48" W x 24" H	Dimensions	60" W x 24" H	Dimensions	72" W x 24" H
PET	\$450	PET	\$525	PET	\$610
Acrylic	\$615	Acrylic	\$690	Acrylic	\$770

Panels

Shelter panels can be outfitted with acoustic felt or acrylic panels. For a complete list of finishes, please visit loftwall.com/shelter.

Name	Description	24x24	24x30	Back Panel
A-kus-tik (AKUS-)	Sound-absorbing panel	Included	Included	Included
Frosted or Clear Acrylic (AC-)	Translucent panel	Included	Included	Included

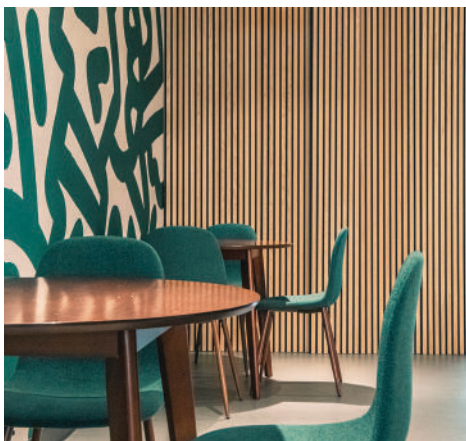
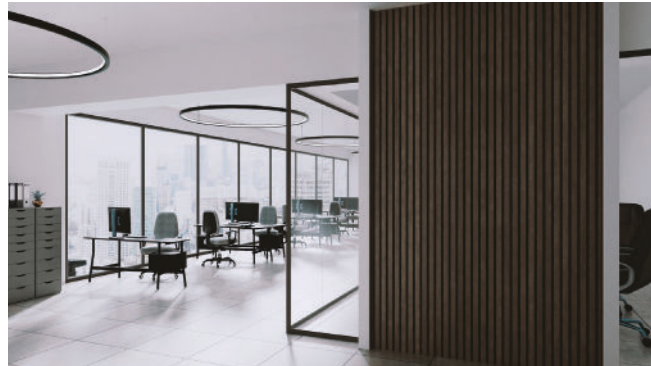
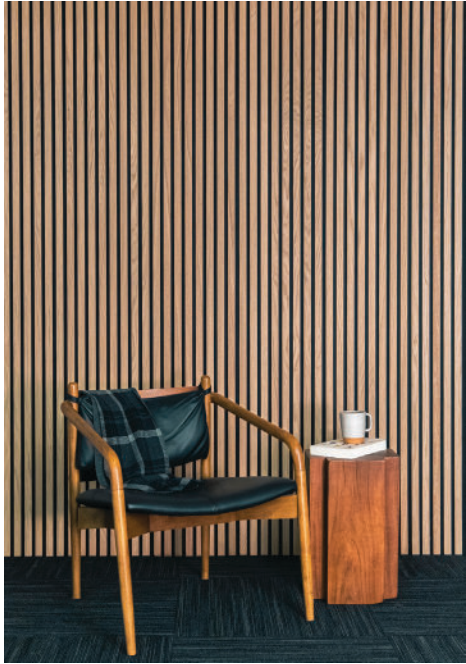

Acoustic Wallcoverings

Felt acoustic wall cladding for offices, hospitals, and schools. Available with a variety of thicknesses, finishes and acoustic properties.

ACOUSTIC WALLCOVERINGS

Arbor.....	51
Tango.....	55
Tempo	61



SCAN FOR MORE VISUAL
REFERENCES OF FEATURED
PRODUCTS

Arbor wallcoverings

Pricing

Available in 3 finishes, 2 styles and 2 size, the only price determining variable is style. All standard panels are priced the same and all slim panels are priced the same.

Typicals

Arbor panels are available in standard or slim thickness. Slim panels have a thinner profile than standard panels. Arbor is available in 3 finishes noted as -XX- in the product SKU.

ARBOR 2x8	ARBOR 2x8 SLIM	ARBOR 2x10	ARBOR 2x10 SLIM
AR-28-STD-XX-XX	AR-28-SLIM-XX-XX	AR-210-STD-XX-XX	AR-210-SLIM-XX-XX
Dimensions 24" W x 95" H	Dimensions 24" W x 95" H	Dimensions 24" W x 118" H	Dimensions 24" W x 118" H
Panel(s) (1) Arbor Panel	Panel(s) (1) Arbor Panel	Panel(s) (1) Arbor Panel	Panel(s) (1) Arbor Panel
Price \$425	Price \$350	Price \$640	Price \$525

Price per Sq Ft.

Often times it is simpler to price wall panels by square foot. Below is a graph that illustrates the cost of Arbor panels based on model and panel spacing. Please keep in mind, pricing by square foot assumes there are no panels being cut. Once a panel is cut, it may not be reusable in other areas due to the interlocking or variance between the left and right side of the panel.

Size	List Price	Dimensions	Price Per Square Foot
Arbor 2x8	\$425.00	15.5 sq ft	\$27.42
Arbor 2x8 Slim	\$350.00	15.5 sq ft	\$22.58
Arbor 2x10	\$640.00	19.37 sq ft	\$33.04
Arbor 2x10 Slim	\$525.00	19.37 sq ft	\$27.10

Arbor Reserve wallcoverings

Pricing

Available in 20 finishes, 2 styles and 2 sizes. Arbor Reserve has a minimum order quantity of 50 panels. Lead times can take up to 12+ weeks.

Typicals

Arbor Reserve panels are available in standard or slim thickness. Slim panels have a thinner profile than standard panels. Arbor is available in 5 wood finishes and 4 PET backers, both noted as -XX- in the product SKU.

ARBOR RESERVE 2x8	ARBOR RESERVE 2x8 SLIM	ARBOR RESERVE 2x10	ARBOR RESERVE 2x10 SLIM
AR-28-STD-XX-XX	AR-28-SLIM-XX-XX	AR-210-STD-XX-XX	AR-210-SLIM-XX-XX
Dimensions 24" W x 95" H	Dimensions 24" W x 95" H	Dimensions 24" W x 118" H	Dimensions 24" W x 118" H
Panel(s) (1) Arbor Panel	Panel(s) (1) Arbor Panel	Panel(s) (1) Arbor Panel	Panel(s) (1) Arbor Panel
Price \$470	Price \$385	Price \$705	Price \$580

Price per Sq Ft.

Often times it is simpler to price wall panels by square foot. Below is a graph that illustrates the cost of Arbor Reserve panels based on model and panel spacing. Please keep in mind, pricing by square foot assumes there are no panels being cut. Once a panel is cut, it may not be reusable in other areas due to the interlocking or variance between the left and right side of the panel.

Size	List Price	Dimensions	Price Per Square Foot
Arbor Reserve 2x8	\$470.00	15.5 sq ft	\$30.32
Arbor Reserve 2x8 Slim	\$385.00	15.5 sq ft	\$24.84
Arbor Reserve 2x10	\$580.00	19.37 sq ft	\$29.94
Arbor Reserve 2x10 Slim	\$705.00	19.37 sq ft	\$36.40





Tango wallcoverings

Pricing

While specific Tango panel prices vary by shape and size, panels roughly follow a \$33 per square foot pricing structure.

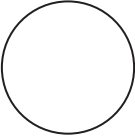
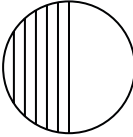
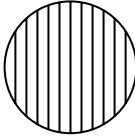
Typicals

Tango is available in eight unique shapes, two unique sizes (large and small), and a variety of styles. For an added design flair, select panels can be outfitted with a series of beveled lines - we refer to this pattern as "corduroy". Panels with full corduroy will have SKUs featuring "FP", half corduroy panels will be "HP", and no corduroy will be "NP". The X's in each SKU refer to the finish of the panel. For a complete list of finishes, please visit loftwall.com/tango.

CIRCLE - LARGE					
	AKUS-TANGO-CIR-LG-NP-XX	AKUS-TANGO-CIR-LG-HP-XX	AKUS-TANGO-CIR-LG-FP-XX		
Dimensions	23.75" x 23.75"	Dimensions	23.75" x 23.75"	Dimensions	23.75" x 23.75"
Price of 1	\$100	Price of 1	\$100	Price of 1	\$100
CIRCLE - SMALL					
	AKUS-TANGO-CIR-SM-NP-XX	AKUS-TANGO-CIR-SM-HP-XX	AKUS-TANGO-CIR-SM-FP-XX		
Dimensions	11.875" x 11.875"	Dimensions	11.875" x 11.875"	Dimensions	11.875" x 11.875"
Price of 1	\$25	Price of 1	\$25	Price of 1	\$25

HALF CIRCLE - LARGE



AKUS-TANGO-HCR-LG-NP-XX

Dimensions 23.75" x 11.875"

Price of 1 \$50

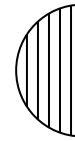

AKUS-TANGO-HCR-LG-HP-XX

Dimensions 23.75" x 11.875"

Price of 1 \$50

HALF CIRCLE - SMALL



AKUS-TANGO-HCR-SM-NP-XX

Dimensions 5.9375" x 11.875"

Price of 1 \$13



AKUS-TANGO-HCR-SM-FP-XX

Dimensions 5.9375" x 11.875"

Price of 1 \$13

TRIANGLE - LARGE

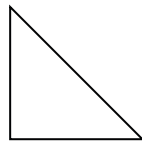

AKUS-TANGO-TRI-LG-NP-XX

Dimensions 23.75" x 23.75"

Price of 1 \$68

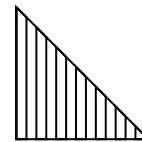

AKUS-TANGO-TRI-LG-FP-XX

Dimensions 23.75" x 23.75"

Price of 1 \$68

Tango wallcoverings

Typicals
Continued

TRIANGLE - SMALL



AKUS-TANGO-TRI-SM-NP-XX

Dimensions 11.875" x 11.875"

Price of 1 **\$17**



AKUS-TANGO-TRI-SM-FP-XX

Dimensions 11.875" x 11.875"

Price of 1 **\$17**

PLANK - LARGE

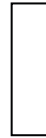

AKUS-TANGO-PLA-LG-NP-XX

Dimensions 23.75" x 5.9375"

Price of 1 **\$132**



AKUS-TANGO-PLA-LG-FP-XX

Dimensions 23.75" x 5.9375"

Price of 1 **\$132**

PLANK - SMALL



AKUS-TANGO-PLA-SM-NP-XX

Dimensions 3" x 11.875"

Price of 1 **\$33**



AKUS-TANGO-PLA-SM-FP-XX

Dimensions 3" x 11.875"

Price of 1 **\$33**

SQUARE - LARGE



AKUS-TANGO-SQU-LG-NP-XX

Dimensions 23.75" x 23.75"

Price of 1 \$132

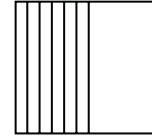

AKUS-TANGO-SQU-LG-HP-XX

Dimensions 23.75" x 23.75"

Price of 1 \$132

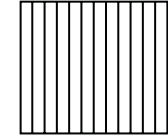

AKUS-TANGO-SQU-LG-FP-XX

Dimensions 23.75" x 23.75"

Price of 1 \$132

SQUARE - SMALL



AKUS-TANGO-SQU-SM-NP-XX

Dimensions 11.875" x 11.875"

Price of 1 \$33



AKUS-TANGO-SQU-SM-HP-XX

Dimensions 11.875" x 11.875"

Price of 1 \$33



AKUS-TANGO-SQU-SM-FP-XX

Dimensions 11.875" x 11.875"

Price of 1 \$33

RECTANGLE - LARGE



AKUS-TANGO-REC-LG-NP-XX

Dimensions 11.875" x 23.75"

Price of 1 \$68

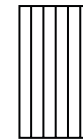

AKUS-TANGO-REC-LG-FP-XX

Dimensions 11.875" x 23.75"

Price of 1 \$68

Tango wallcoverings

Typicals
Continued

RECTANGLE - SMALL



AKUS-TANGO-REC-SM-NP-XX

Dimensions 5.9375" x 11.875"

Price of 1 **\$17**



AKUS-TANGO-REC-SM-FP-XX

Dimensions 5.9375" x 11.875"

Price of 1 **\$17**

HEXAGON - LARGE

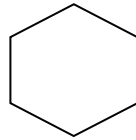

AKUS-TANGO-HEX-LG-NP-XX

Dimensions 27.4325" x 23.75"

Price of 1 **\$120**

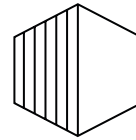

AKUS-TANGO-HEX-LG-HP-XX

Dimensions 27.4325" x 23.75"

Price of 1 **\$120**

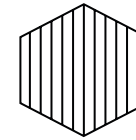

AKUS-TANGO-HEX-LG-FP-XX

Dimensions 27.4325" x 23.75"

Price of 1 **\$120**

HEXAGON - SMALL



AKUS-TANGO-HEX-SM-NP-XX

Dimensions 13.6875" x 11.875"

Price of 1 **\$30**



AKUS-TANGO-HEX-SM-HP-XX

Dimensions 13.6875" x 11.875"

Price of 1 **\$30**



AKUS-TANGO-HEX-SM-FP-XX

Dimensions 13.6875" x 11.875"

Price of 1 **\$30**

SQUARE - LARGE

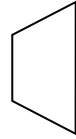

AKUS-TANGO-TRA-LG-NP-XX

Dimensions 27.4325" x 11.875"

Price of 1 **\$60**

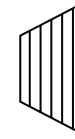

AKUS-TANGO-TRA-LG-FP-XX

Dimensions 27.4325" x 11.875"

Price of 1 **\$60**

SQUARE - SMALL



AKUS-TANGO-TRA-SM-NP-XX

Dimensions 13.6875" x 5.9375"

Price of 1 **\$15**



AKUS-TANGO-TRA-SM-FP-XX

Dimensions 13.6875" x 5.9375"

Price of 1 **\$15**

Panels

Tango is available in a variety of acoustic felt finishes. For a complete list of finishes, please visit loftwall.com/tango.

Name	Description
PET felt (AKUS-)	Sound-absorbing panel

Tempo wallcoverings

Pricing

To price a Tempo wall grid, select a thickness-based SKU. While attached panels are available in a variety in finishes and patterns, all panels are priced the same.

Typicals

Tempo wall grids are available with eight, 9mm or 12mm acoustic felt panels. Tempo is available in 24 finishes noted as -XX- in the product SKU.

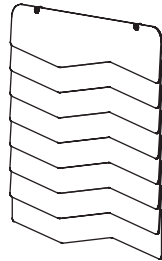

TM-RAW-WALL-XX

Dimensions	48" W x 49" H
Panel(s)	(8) Tempo Panels
9mm Price	\$1,110
12mm Price	\$1,185

Price per Sq Ft.

Often times it is simpler to price wall panels by square foot. Below is a graph that illustrates the cost of wall panels based on model and panel spacing.

Size	List Price	Dimensions	Price Per Square Foot
9mm White Ash	\$1,100.00	16 sq ft	\$68.05
1/2" White Ash	\$1,185.00	16 sq ft	\$74.06

Panels

Tempo panels are available in a variety of acoustic felt finishes and patterns. For a complete list of finishes and patterns, please visit loftwall.com/tempo. All panel finishes and patterns have the same price.

Name	Description
PET felt (AKUS-PANEL-*STYLE*-FINISH)	Sound-absorbing panel

Grid Typicals

Please note, multiple Tempo ceiling grids can be installed next to each other to create continuous runs.

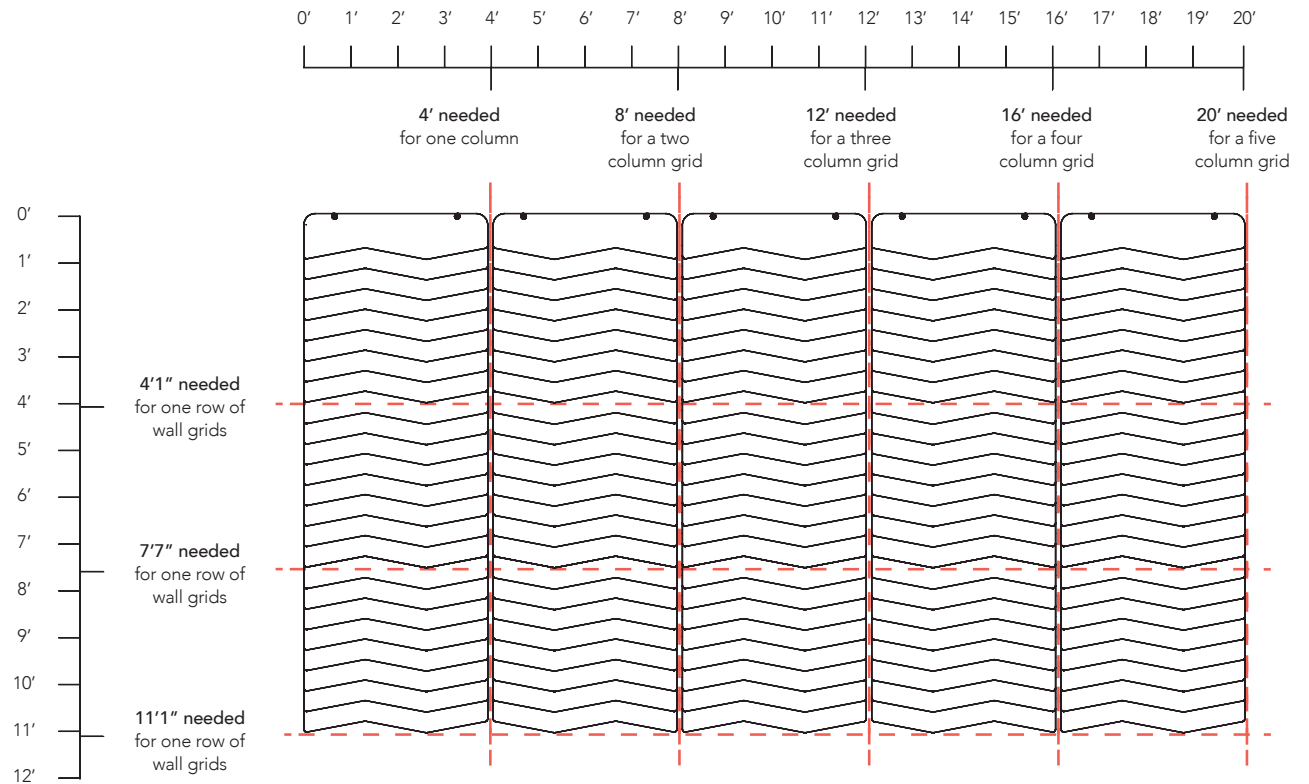

Tempo wallcoverings

Available Designs

Tempo wall grids are available in 4 standard designs. All panels are priced the same, regardless of selected design.



Turn 1



Turn 2

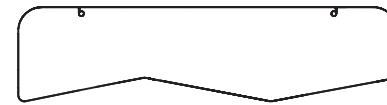

Turn 3



Tilt 1



Tilt 2

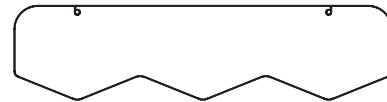

Tilt 3

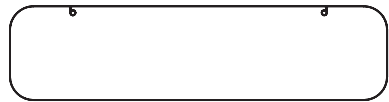

Tab 1



Tab 2

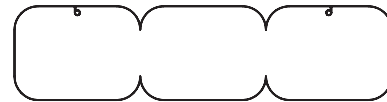

Tab 3



Tide 1



Tide 2



Tide 3

Hardware

Tempo wall grids are shipped with the necessary mounting brackets at no additional cost.

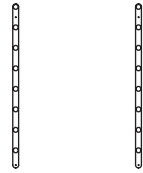

MOUNTING BRACKET

33" W x 42" H



Architectural

Wall-mounted, ceiling-mounted, ceiling track, and floor-mounted room dividers for offices, hospitals, and schools.
Screens are made in the USA and ship quickly.

ARCHITECTURAL

Glide	67
Hover	71
Pivot.....	73
Rooms.....	75



SCAN FOR MORE VISUAL
REFERENCES OF FEATURED
PRODUCTS





Glide architectural

Pricing

To price Glide, select a size-based SKU and request a quote from us to determine the right panel and size for your space.

Typicals

Glide is available in 9 unique size-based styles. Glide offers 12 finishes noted as -XX- in the product SKU.

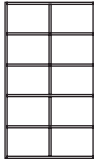
	78" TALL	103" TALL	128" TALL
50" WIDE			
	GL-XX-4-3	GL-XX-4-4	GL-XX-4-5
	Frame <u>\$970</u>	Frame <u>\$1,235</u>	Frame <u>\$1,525</u>
	Panel(s) (3) 2x4 <u>\$1,420</u>	Panel(s) (4) 2x4 <u>\$1,835</u>	Panel(s) (5) 2x4 <u>\$2,275</u>
	Level 1 Panels <u>\$1,420</u>	Level 1 Panels <u>\$1,835</u>	Level 1 Panels <u>\$2,275</u>
	Level 2 Panels <u>\$1,675</u>	Level 2 Panels <u>\$2,175</u>	Level 2 Panels <u>\$2,700</u>
74" WIDE			
	GL-XX-6-3	GL-XX-6-4	GL-XX-6-5
	Frame <u>\$1,525</u>	Frame <u>\$1,865</u>	Frame <u>\$2,205</u>
	Panel(s) (6) 2x3 <u>\$2,425</u>	Panel(s) (8) 2x3 <u>\$3,065</u>	Panel(s) (10) 2x3 <u>\$3,705</u>
	Level 1 Panels <u>\$2,425</u>	Level 1 Panels <u>\$3,065</u>	Level 1 Panels <u>\$3,705</u>
	Level 2 Panels <u>\$2,935</u>	Level 2 Panels <u>\$3,745</u>	Level 2 Panels <u>\$4,555</u>

Typicals Continued

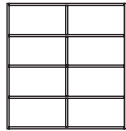
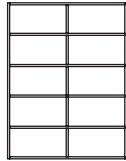
	78" TALL	103" TALL	128" TALL
98" WIDE			
	GL-XX-8-3	GL-XX-8-4	GL-XX-8-5
	Frame	Frame	Frame
	Panel(s)	Panel(s)	Panel(s)
	\$1,810	\$2,205	\$2,625
	(6) 2x4	(8) 2x4	(10) 2x4
	\$2,710	\$3,405	\$4,125
	\$3,220	\$4,085	\$4,975

Frame Colors

Glide is available in 3 standard frame finishes, Black (BK), White (WH), and Silver (SV) noted in place of -XX- in the product SKU. All standard frame finishes are priced the same. Custom colors may be available upon request.

Name	Price
Silver, White, and Black	Price included in product.
Custom Colors and Finishes	Contact us for a quote!

Panels

Glide panels are available in a variety of finishes.

Level	Name	Description
1	PET felt (AKUS-)	Sound-absorbing panel
1	Twinwall Polycarbonate (TW-)	Translucent panel

Panels Continued

Level	Name	Description
2	Frosted or Clear Acrylic (AC-)	Translucent panel
2	Cutout Composite Panel (WEB-)	Web
2	Laminates (SC-)	Woodgrain and solid finishes
2	Chisel (*PATTERN*-AKUS-)	Acoustic knife cut design panels

Hardware

All Glide panels need overhead track to attach to. Please note the price change for track at 60" in length.

Name	Description	Level
GL-TRK-60	<60" Single Track Section	\$105
GL-TRK-94	>60" Single Track Section	\$200

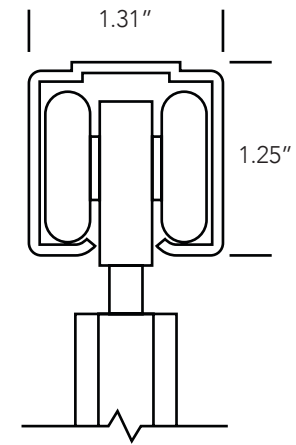

Hover architectural

Pricing

To price Hover, select a size-based SKU and add the price of selected infill panels as well as the base. There is no price difference for various frame finishes.

Typicals

Hover is available in 3 unique size-based styles. Hover offers 3 frame finishes noted as -XX- in the product SKU.

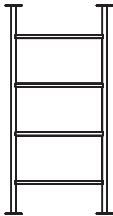
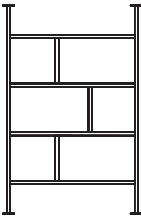
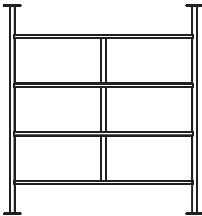
	52" WIDE	76" WIDE	100" WIDE
78" TALL			
	HV-XX-4	HV-XX-6	HV-XX-8
Dimensions	52" W x 78" H	76" W x 78" H	100" W x 78" H
Panel(s)	(3) 2x4	(3) 2x2, (3) 2x4	(6) 2x4
Price	\$1,500	\$1,975	\$2,425

Panels

Hover divider panels are compatible with a variety of panels. Please note the price difference of each panel type. Small panels are 2'x2', medium panels are 2'x3', and large panels are 2'x4'.

Level	Name	Description	2x2	2x4
1	PET felt (AKUS-)	Sound-absorbing panel	\$75	\$150
1	Twinwall Polycarbonate (TW-)	Translucent panel	\$75	\$150
2	Frosted or Clear Acrylic (AC-)	Translucent panel	\$120	\$235
2	Nonmagnetic Dry Erase (DEP-)	White dry erase surface	\$120	\$235

Panels Continued

Level	Name	Description	2x2	2x4
2	Cutout Composite Panel (PEG-) (WEB-)	Pegboard & Web	\$120	\$235
2	Laminates (SC-)	Woodgrain and solid finishes	\$120	\$235
2	Chisel (*PATTERN*-AKUS-)	Acoustic knife cut design panels	\$120	\$235
3	Magnetic Dry Erase (DEM-)	White dry erase surface	\$370	\$730
3	Custom Artwork Panel	Custom branded panels	quote	quote
3	Custom Material Panel	3Form, Lumicor, Wilsonart	quote	quote

Frame Colors

Hover is available in 3 standard frame finishes, Black (BK), White (WH), and Silver (SV) noted in place of -XX- in the product SKU. All standard frame finishes are priced the same. Custom colors may be available upon request.

Finish	Price
Silver, White, and Black	Price included in product.
Custom Colors and Finishes	Contact us for a quote!

Bases

Hover is available with two standard base options. There are 3 available finishes: Black (BK), White (WH), and Silver (SV) noted in place of -XX- in the product SKU. All base finishes are included in the price. Bases are not included in the listed price under the typical section.



BP-06-XX

6" Floor/Non-Floor Mount

Price \$125 per

Pricing

To price Pivot, select a size-based SKU and a delivery method. Pivots are shipped fully assembled.

Typicals

Pivot is available in 6 unique size-based styles. Pivot offers 3 frame finishes noted as -XX- in the product SKU.

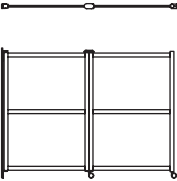
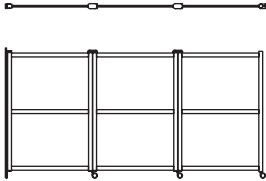
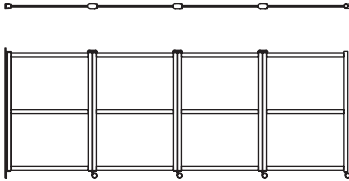
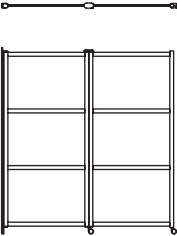
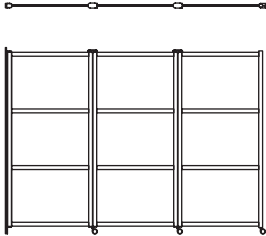
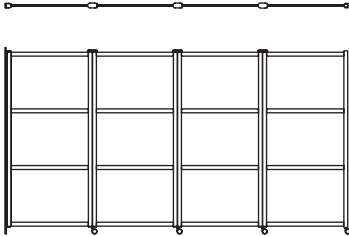
	77" WIDE	115" WIDE	153" WIDE
57" TALL			
	PV-XX-LH-2S	PV-XX-LH-3S	PV-XX-LH-4S
	Dimensions <u>77" W x 57" H</u>	Dimensions <u>115" W x 57" H</u>	Dimensions <u>153" W x 57" H</u>
	Panel(s) <u>(4) 2x3</u>	Panel(s) <u>(6) 2x3</u>	Panel(s) <u>(8) 2x3</u>
	Price <u>\$3,830</u>	Price <u>\$5,755</u>	Price <u>\$7,675</u>
82" TALL			
	PV-XX-FH-2S	PV-XX-FH-3S	PV-XX-FH-4S
	Dimensions <u>77" W x 82" H</u>	Dimensions <u>115" W x 82" H</u>	Dimensions <u>153" W x 82" H</u>
	Panel(s) <u>(6) 2x3</u>	Panel(s) <u>(9) 2x3</u>	Panel(s) <u>(12) 2x3</u>
	Price <u>\$4,850</u>	Price <u>\$7,265</u>	Price <u>\$9,685</u>

Panels

Pivot walls are compatible with a variety of panel inserts. For Pivot, all panel inserts are priced the same.

Name	Description
PET felt (AKUS-)	Sound-absorbing panel
Twinwall Polycarbonate (TW-)	Translucent panel
Frosted or Clear Acrylic (AC-)	Translucent panel
Nonmagnetic Dry Erase (DEP-)	White dry erase surface
Cutout Composite Panel (PEG-) (WEB-)	Pegboard & Web
Laminates (SC-)	Woodgrain and solid finishes
Chisel (*PATTERN*-AKUS-)	Acoustic knife cut design panels
Magnetic Dry Erase (DEM-)	White dry erase surface
Custom Artwork Panel	Custom branded panels
Custom Material Panel	3Form, Lumicor, Wilsonart

Frame Colors

Pivot is available in 3 standard frame finishes, Black (BK), White (WH), and Silver (SV) noted in place of -XX- in the product SKU. All standard frame finishes are priced the same. Custom colors may be available upon request.

Finish	Price
Silver, White, and Black	Price included in product.
Custom Colors and Finishes	Contact us for a quote!

Hardware

Pivot comes standard with non-locking casters. Locking casters can be added for no additional price.

Rooms architectural

Pricing

To price a Room, determine the number of 2', 3', and 4' walls and doors you require and any additional mounting needed (floor wall mounting available). While walls and doors are available in various styles and with frame and panel finishes, all styles and finishes are priced the same.

Wall Typicals

Rooms can be divided into 5 modular SKUs: 2' walls, 3' walls, 3' doors, 4' walls and 4' doors. Rooms is available in 3 frame finishes noted as -XX- in the product SKU; and features 3 wall styles noted as the last X in the SKU. For additional wall styles please visit loftwall.com/rooms.



RM-XX-2-8.X

Dimensions	2' W x 92" H
2' Wall	\$1,590
2' Door	N/A



RM-XX-3/RM-DR-XX-3-8.X

Dimensions	3' W x 92" H
3' Wall	\$1,850
3' Door	\$2,850

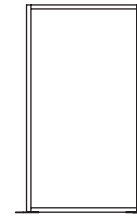

RM-XX-4/RM-DR-XX-4-8.X

Dimensions	4' W x 92" H
4' Wall	\$2,050
4' Door	\$3,050

Wall Styles

Each wall in Rooms can feature any one of our wall styles. All walls are priced the same, regardless of selected style.

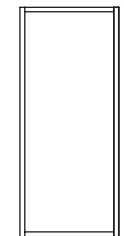

STYLE 1

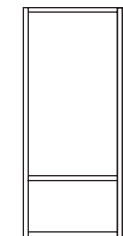

STYLE 2

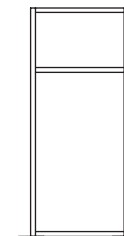

STYLE 3

Panels

Rooms are available with a variety of material. Please note, all Rooms panels are priced the same. For a comprehensive list of what panels are compatible with each wall style, please visit loftwall.com/rooms.

Level	Name	Description
1	PET felt (AKUS-)	Sound-absorbing panel
1	Twinwall Polycarbonate (TW-)	Translucent panel
2	Frosted or Clear Acrylic (AC-)	Translucent panel
2	Nonmagnetic Dry Erase (DEP-)	White dry erase surface
2	Cutout Composite Panel (PEG-) (WEB-)	Pegboard & Web
2	Laminates (SC-)	Woodgrain and solid finishes
2	Chisel (*PATTERN*-AKUS-)	Acoustic knife cut design panels
3	Magnetic Dry Erase (DEM-)	White dry erase surface
3	Blox Panel (BLX-)	Up to 85% sound absorption
3	Custom Artwork Panel	Custom branded panels
3	Custom Material Panel	3Form, Lumicor, Wilsonart

Frame Colors

Rooms is available in 3 standard frame finishes, Black (BK), White (WH), and Silver (SV) noted in place of -XX- in the product SKU. All standard frame finishes are priced the same. Custom colors may be available upon request.

Name	Price
Silver, White, and Black	Price included in product.
Custom Colors and Finishes	Contact us for a quote!

Rooms architectural

Shape Typicals

Simple designs intended to get the ball rolling, Rooms Shapes can be combined and even grow overtime as your space's needs change. Rooms Shapes is available in 3 frame finishes noted as -XX- in the product SKU. Rooms Shapes must be wall mounted for stability.

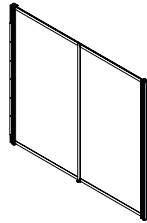

I SHAPE

2' Walls	\$1,590 per
3' Walls	\$1,850 per
4' Walls	\$2,050 per

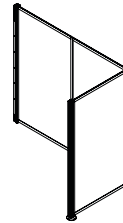

L SHAPE

2' Walls	\$1,590 per
3' Walls	\$1,850 per
4' Walls	\$2,050 per

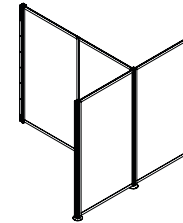

T SHAPE

2' Walls	\$1,590 per
3' Walls	\$1,850 per
4' Walls	\$2,050 per

Pod Typicals

6' x 6' focus spaces designed to move you into a productive flow state. Perfect as dedicated workspaces or retreat relaxation zones. Available in all wall styles. Rooms is available in 3 frame finishes noted as -XX- in the product SKU.

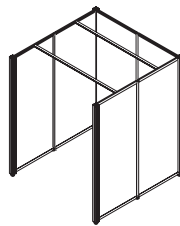

RM-XX-6X6-POD

Dimensions	72" W x 92" H x 72" D
Panels Used	(6) 3' Wide
Price	\$11,100

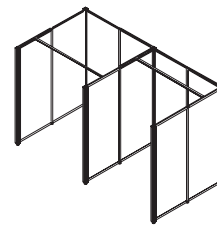

RM-XX-6X12-POD

Dimensions	144" W x 92" H x 72" D
Panels Used	(10) 3' Wide
Price	\$18,500

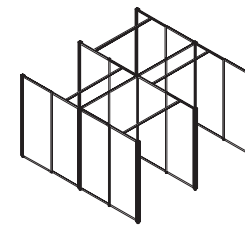

RM-XX-12X12-POD

Dimensions	144" W x 92" H x 144" D
Panels Used	(16) 3' Wide
Price	\$29,600

Small Group Typicals

Small group touchdown spaces. Designed and stylized for maximum collaboration for groups of 2 - 6 people. Available in all wall styles.

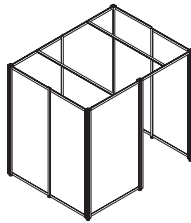

RM-XX-8X6-SMALLGROUP

Dimensions	96" W x 92" H x 72" D
Panels Used	(4) 3' Wide, (3) 4' Wide
Price	\$13,550

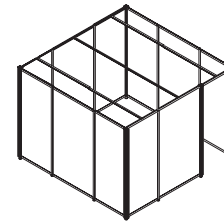

RM-XX-10X10-SMALLGROUP

Dimensions	120" W x 92" H x 120" D
Panels Used	(7) 3' Wide, (4) 4' Wide
Price	\$21,150

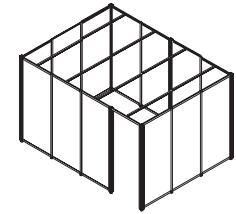

RM-XX-9X12-SMALLGROUP

Dimensions	144" W x 92" H x 108" D
Panels Used	(13) 3' Wide
Price	\$24,050

Large Group Typicals

Large group meeting spaces. War rooms for your team to collaborate in real time. Designed for groups of 7 or more. Available in all wall styles.

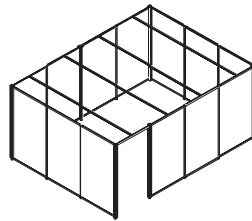

RM-XX-12X16-LARGEGROUP

Dimensions	192" W x 92" H x 144" D
Panels Used	(13) 4' Wide
Price	\$26,520

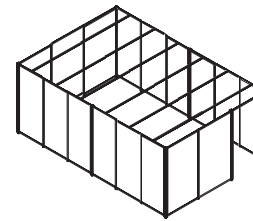

RM-XX-12X18-LARGEGROUP

Dimensions	1216" W x 92" H x 144" D
Panels Used	(12) 3' Wide, (5) 4' Wide
Price	\$31,800

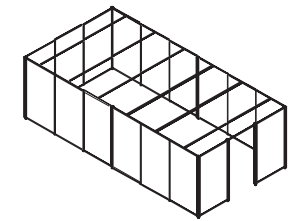

RM-XX-12X24-LARGEGROUP

Dimensions	288" W x 92" H x 144" D
Panels Used	(17) 4' Wide
Price	\$34,680

Rooms architectural

Baffle Typical

For an additional cost, acoustic ceiling baffles can be added to most Rooms. Baffles are priced by the square foot; on average, Rooms baffles are around \$33/SF if exactly quantity is unknown. There are two baffle types available: 9mm thick and 12mm thick. Room Baffles are available in 24 finishes.

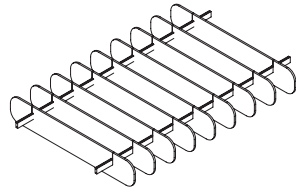

BAFFLES

3' Panels \$66 per panel

4' Panels \$88 per panel

Baffle Typical

Acoustic ceiling baffles can be added to part of or all of a Room.

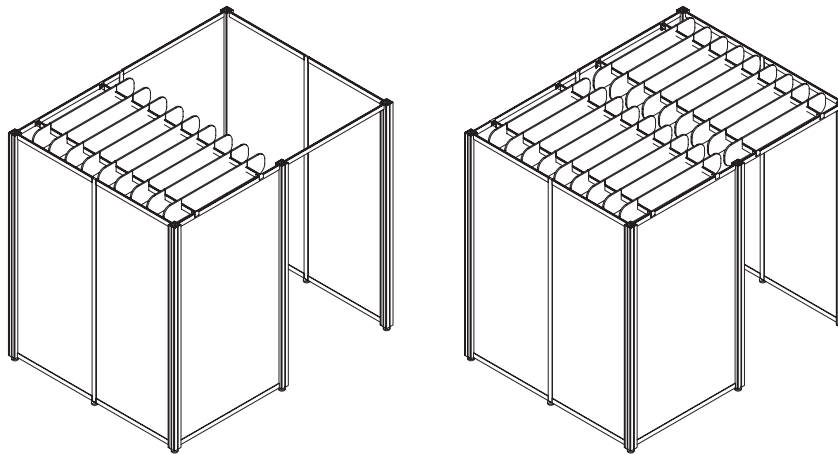

Mounting

All rooms come with freestanding level feet but in some configurations, floor and wall mounting may be required at an additional cost for stability purposes.

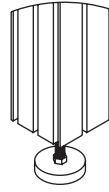

FREE STANDING

with leveling feet list price: \$0

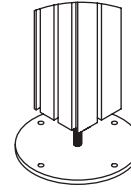

FLOOR MOUNTED

with leveling feet list price: \$225.00



WALL MOUNTED

with leveling feet list price: \$220.00

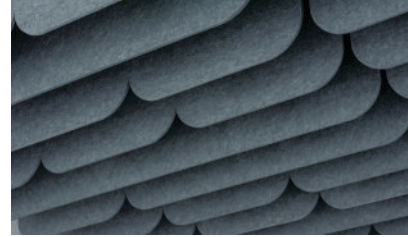

Acoustic Baffles

Commercial-grade acoustic baffle ceiling systems for offices, hospitals, and schools. All of our baffles are made in the USA and ship quickly.

ACOUSTIC BAFFLES

Gravity	83
Layer	87
Sky.....	89
Pocket.....	91
Tempo	93
Thicc	97
Thin.....	99



SCAN FOR MORE VISUAL
REFERENCES OF FEATURED
PRODUCTS





Gravity acoustic baffles

Pricing

To price Gravity, select a size-based SKU and mounting method. All like-sized panels are priced the same regardless of finish or cut pattern.

Dimensions

Gravity panels are available in 2 heights (67" and 91.5") and two thicknesses (9mm and 12mm).

9mm PET		12mm PET	
			
SLAB-AKUS-64-XX-9MM	SLAB-AKUS-84-XX-9MM	SLAB-AKUS-64-XX-1/2	SLAB-AKUS-84-XX-1/2
Dimensions 46" W x 67" H	Dimensions 46" W x 91.5" H	Dim. 46" W x 67" H	Dimensions 46" W x 91.5" H
Panel(s) (1) PET Panel	Panel(s) (1) PET Panel	Panel(s) (1) PET Panel	Panel(s) (1) PET Panel
Price \$600	Price \$700	Price \$700	Price \$800

Cut Patterns

Gravity has 12 different design options for both the full size panel and 3/4 size panel. All standard cut patterns are included in the price. For a 20% up charge, custom designs can be cut into Gravity panels. All custom designs must be approved before ordering.

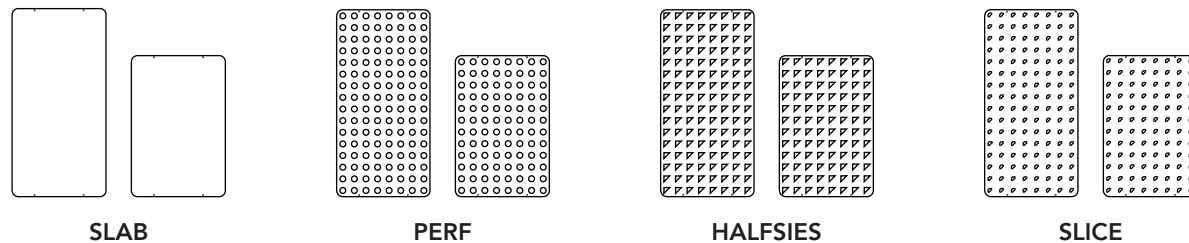

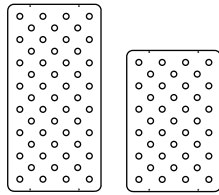

OFFSET

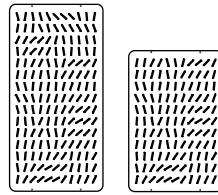

SCATTER

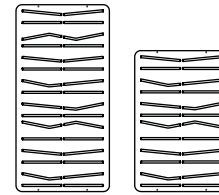

TURN

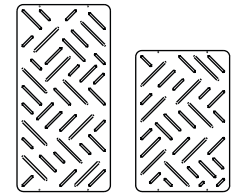

HATCH

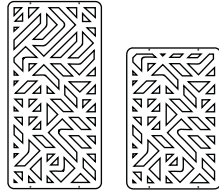

TRANSIT

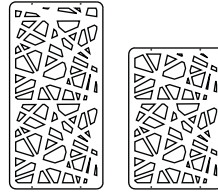

WEB

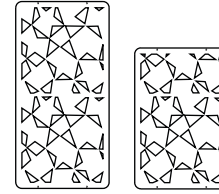

FRACTAL

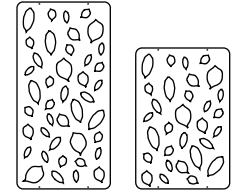

PETAL

Finish

9mm Gravity panels are available in 24 acoustic felt finishes with a variety of cut patterns, 12mm panels are only available in Marble and Charcoal. For a complete list of finishes and patterns, please visit loftwall.com/gravity. All panel finishes are included in the price.

Name	Description
PET felt (*PATTERN*-AKUS-64-*FINISH*)	Sound-absorbing panel

Mounting Typicals

Gravity has 4 ceiling mounting options and 2 floor mounting options, they can be combined to fit your space's needs.



GV-MOUNT-STND

Included



GV-MOUNT-TRACK

\$150



GV-MOUNT-TGRID

\$60

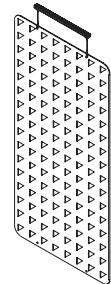

GV-MOUNT-UNIS

\$170

Gravity acoustic baffles

Mounting Typicals

Gravity has 4 ceiling mounting options and 2 floor mounting options, they can be combined to fit your space's needs.

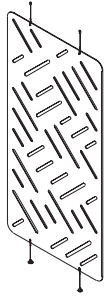

GV-MOUNT-STND-STND

\$200

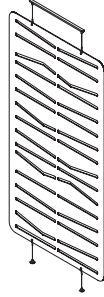

GV-MOUNT-TRACK-STND

\$300



GV-MOUNT-TGRID-STND

\$260

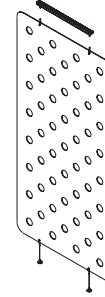

GV-MOUNT-UNIS-STND

\$370

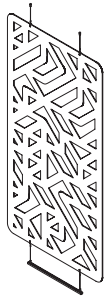

GV-MOUNT-STND-TRACK

\$300



GV-MOUNT-TRACK-TRACK

\$400



GV-MOUNT-TGRID-TRACK

\$360



GV-MOUNT-UNIS-TRACK

\$470

Mounting Hardware

All Gravity panels need to be ceiling mounted with either a ceiling coupler or a ceiling track. For added stability, panels can be floor mounted with a floor track or floor mount base.

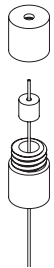
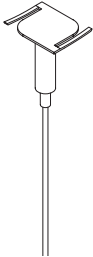
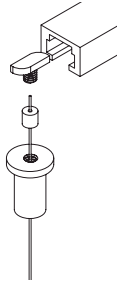
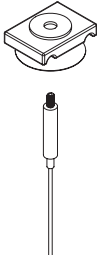
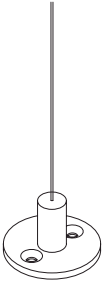
				
Single Point Coupler	T-Grid Clip	*Track/Track Coupler	Unistrut Coupler	Floor Mount
Price <i>Included</i>	Price <i>\$60 per</i>	Price <i>\$150</i>	Price <i>*\$170 per</i>	Price <i>\$170 per</i>

*Track is shipped in 26" increments *Unistrut track is not provided

Layer acoustic baffles

Pricing

To price Layer, select a size-based SKU and mounting method.

Typicals

Layer is available in 3 sizes, all of which use 9mm thick PET.

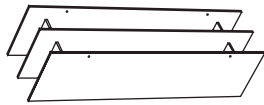

BA-LAY-BASE-SML

Dimensions	47.5" W x 11.75" H x 11.5"
Panel(s)	(1) panel
Price	\$700 per



BA-LAY-BASE-MED

Dimensions	72" W x 11.75" H x 11.5"
Panel(s)	(1) panel
Price	\$900 per

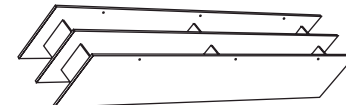

BA-LAY-BASE-LRG

Dimensions	92" W x 11.75" H x 11.5"
Panel(s)	(1) panel
Price	\$1,100 per

Price per Sq Ft.

Often times it is simpler to price baffles by square foot. Below is a graph that illustrates the cost of baffles based on model, size, amount of baffles and baffle spacing.

Size	List Price	Length (ft)	6" Spacing	12" Spacing	24" Spacing	Price Per Square Foot
Small	\$700.00	4	\$175.00	\$87.50	\$43.75	\$175.00
Medium	\$900.00	6	\$150.00	\$75.00	\$37.50	\$150.00
Large	\$1,100.00	7.6	\$144.74	\$72.37	\$36.18	\$144.74

Mounting

Layer needs to be ceiling mounted with either a ceiling coupler, ceiling track or clip.



CEILING COUPLER

Price *Included*

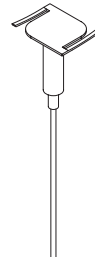

T-GRID CLIP

Price *\$60 per*

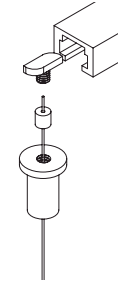

TMU COUPLER & TRACK

Price *\$555*

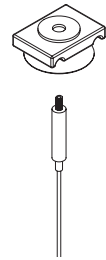

UNISTRUT COUPLER

Price *\$170 per*

Panels

Layer is available in a variety of acoustic felt finishes. For a complete list of finishes please visit loftwall.com/layer. All panel finishes and designs are priced the same.

Name	Description
PET felt (AKUS-)	Sound-absorbing panel

Designs

Layer has three different design options for all three of its sizes.



BASE



PITCH



WAVE

Sky acoustic baffles

Pricing

To price Sky, select a thickness-based SKU and mounting method. All like-sized panels are priced the same regardless of finish or cut pattern.

Typicals

Sky is available in 9mm and 12mm acoustic PET.

9mm PET

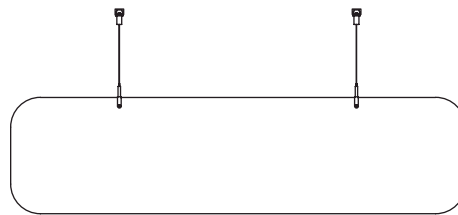

SLAB-AKUS-14-XX-9MM

Dimensions	46" W x 11.75" H x .25" D
Panel(s)	(1) Sky Panel
Price	\$170

12mm PET

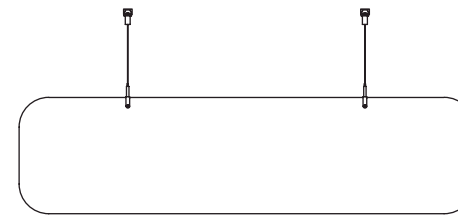

SLAB-AKUS-14-XX-12MM

Dimensions	46" W x 11.75" H x .5" D
Panel(s)	(1) Sky Panel
Price	\$185

Price per Sq Ft.

Often times it is simpler to price baffles by square foot. Below is a graph that illustrates the cost of baffles based on model, size, amount of baffles and baffle spacing.

Size	List Price	Length (ft)	6" Spacing	12" Spacing	24" Spacing	Price Per Square Foot
1/4"	\$160.00	4	\$80.00	\$40.00	\$20.00	\$40.00
1/2"	\$175.00	4	\$87.50	\$43.75	\$21.88	\$43.75

Mounting

All Sky panels need to be ceiling mounted with either a ceiling coupler or a ceiling track.

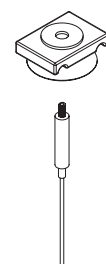
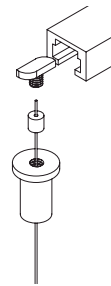
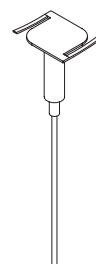
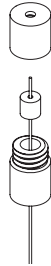

CEILING COUPLER

Price *Included*

T-GRID CLIP

Price *\$60 per baffle*

TMU COUPLER & TRACK

Price *\$150 per baffle*

*UNISTRUT COUPLER

Price *\$170 per baffle*

*Unistrut tracks are not included

Finish

9mm Sky panels are available in 24 acoustic felt finishes with a variety of cut patterns, 12mm panels are only available in Marble and Charcoal. For a complete list of finishes and patterns, please visit loftwall.com/sky. All panel finishes are included in the price.

Name	Description
PET felt (*PATTERN*-AKUS-14-*FINISH*)	Sound-absorbing panel

Designs

Sky has 12 different design options for to choose from. For a 20% up charge, custom designs can be cut into Gravity panels. All custom designs must be approved before ordering.



SLAB

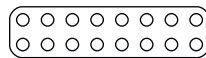

PERF

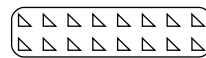

HALFSIES

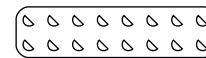

SLICE

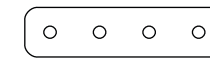

OFFSET



SCATTER

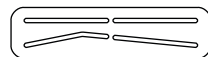

TURN

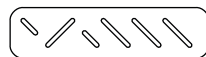

HATCH



TRANSIT



WEB

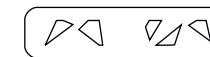

FRACTAL

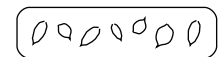

PETAL

Pocket acoustic baffles

Pricing

To price Pocket, select a size-based SKU and mounting method.

Typicals

Pocket is available in 3 sizes, all of which use 9mm thick PET.



BA-PKT-BASE-SML

Dimensions	47.5" W x 11.75" H x 2"
Panel(s)	(1) panel
Price	\$215 per



BA-PKT-BASE-MED

Dimensions	72" W x 11.75" H x 2"
Panel(s)	(1) panel
Price	\$325 per



BA-PKT-BASE-LRG

Dimensions	92" W x 11.75" H x 2"
Panel(s)	(1) panel
Price	\$430 per

Price per Sq Ft.

Often times it is simpler to price baffles by square foot. Below is a graph that illustrates the cost of baffles based on model, size, amount of baffles and baffle spacing.

Size	List Price	Length (ft)	6" Spacing	12" Spacing	24" Spacing	Price Per Square Foot
Small	\$215.00	4	\$107.50	\$53.75	\$26.88	\$53.75
Medium	\$325.00	6	\$108.33	\$54.17	\$27.08	\$54.17
Large	\$430.00	7.6	\$113.16	\$56.58	\$28.29	\$56.58

Mounting

Pocket needs to be ceiling mounted with either a ceiling coupler, ceiling track or clip.



CEILING COUPLER

Price *Included*

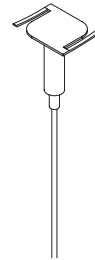

T-GRID CLIP

Price *\$60 per*

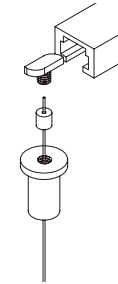

TMU COUPLER & TRACK

Price *\$555*



UNISTRUT COUPLER

Price *\$170 per*

Panels

Pocket is available in a variety of acoustic felt finishes. For a complete list of finishes please visit loftwall.com/pocket. All panel finishes and designs are priced the same.

Name	Description
PET felt (AKUS-)	Sound-absorbing panel

Designs

Pocket has three different design options for all three of its sizes.



BASE

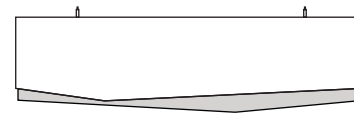

PITCH

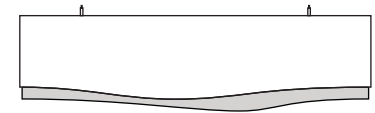

WAVE

Tempo acoustic baffles

Pricing

To price a Tempo ceiling grid, select a thickness-based SKU. While attached panels are available in a variety in finishes and patterns, all panels are priced the same.

Typicals

Tempo ceiling grids are available with eight 9mm or 12mm acoustic felt panels. Tempo is available in 24 finishes noted as -XX- in the product SKU.

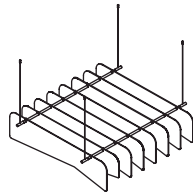

TM-XX-CEILING-XX-9MM

Dimensions	48" W x 12" H x 51" D
Panel(s)	(8) 9mm Panels
White Ash Dowel	\$1,110
Aspen Dowel	\$1,340
Ebony Dowel	\$1,340

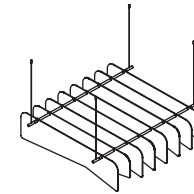

TM-XX-CEILING-XX-1/2

Dimensions	48" W x 12" H x 51" D
Panel(s)	(8) 12mm Panels
White Ash Dowel	\$1,185
Aspen Dowel	\$1,425
Ebony Dowel	\$1,425

Price per Sq Ft.

Often times it is simpler to price baffles by square foot. Below is a graph that illustrates the cost of baffles based on model, size, amount of baffles and baffle spacing.

Size	List Price	Dimensions	Price Per Square Foot
1/4" White Ash	\$1,100.00	16 sq ft	\$69.38
1/2" White Ash	\$1,185.00	16 sq ft	\$74.06
1/4" Other	\$1,340.00	16 sq ft	\$83.75
1/2" Other	\$1,425.00	16 sq ft	\$89.06

Panels

Tempo panels are available in a variety of acoustic felt finishes and patterns. For a complete list of finishes and patterns, please visit loftwall.com/tempo. All panel finishes and patterns have the same price.

Name	Description
PET felt (AKUS-PANEL-*STYLE*-*FINISH*)	Sound-absorbing panel

Grid Typicals

Please note, multiple Tempo ceiling grids can be installed next to each other to create continuous runs.

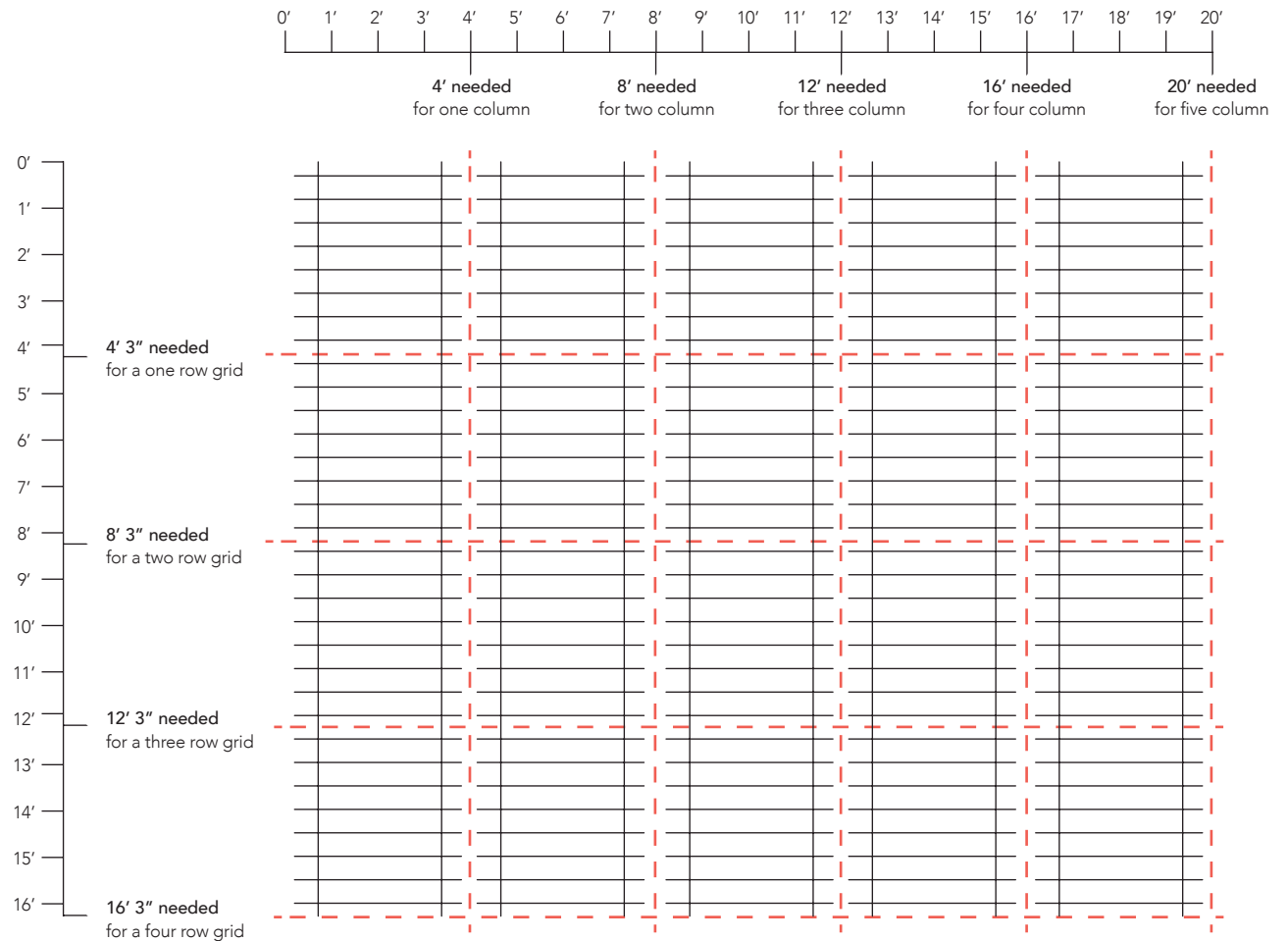

Tempo acoustic baffles

Available Designs

Tempo ceiling grids are available in 4 standard designs. All panels are priced the same, regardless of selected design.

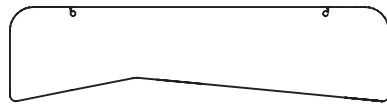

Turn 1



Turn 2

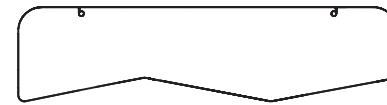

Turn 3



Tilt 1



Tilt 2

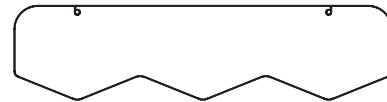

Tilt 3



Tab 1



Tab 2

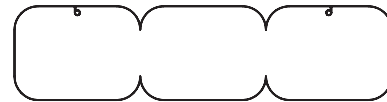

Tab 3



Tide 1



Tide 2



Tide 3

Hardware

Tempo ceiling grids are mounted with 4 ceiling couplers, 4 cables, and 2 dowel rods. Standard ceiling grids have a white ash dowel rod. For an additional cost, Aspen or Ebony dowel rods are available.

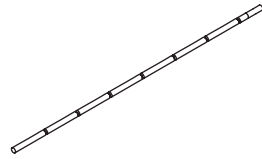

DOWEL ROD



CEILING COUPLER

Thicc acoustic baffles

Pricing

To price Thicc, select a size-based SKU and mounting method.

Typicals

Thicc is available in 3 sizes, all of which use 9mm thick PET.



BA-THC-BASE-SML

Dimensions	47.5" W x 11.75" H x 3"
Panel(s)	(1) panel
Price	\$230 per



BA-THC-BASE-MED

Dimensions	72" W x 11.75" H x 3"
Panel(s)	(1) panel
Price	\$340 per



BA-THC-BASE-LRG

Dimensions	92" W x 11.75" H x 3"
Panel(s)	(1) panel
Price	\$450 per

Price per Sq Ft.

Often times it is simpler to price baffles by square foot. Below is a graph that illustrates the cost of baffles based on model, size, amount of baffles and baffle spacing.

Size	List Price	Length (ft)	6" Spacing	12" Spacing	24" Spacing	Price Per Square Foot
Small	\$120.00	4	\$60.00	\$30.00	\$15.00	\$30.00
Medium	\$180.00	6	\$60.00	\$30.00	\$15.00	\$30.00
Large	\$240.00	7.6	\$63.16	\$31.58	\$15.79	\$31.58

Mounting

Thicc needs to be ceiling mounted with either a ceiling coupler, ceiling track or clip.

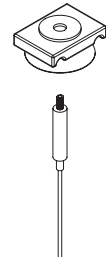
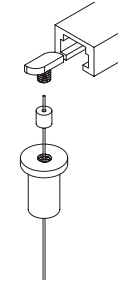
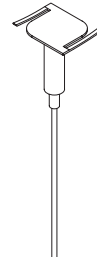
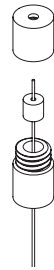

CEILING COUPLER

Price *Included*

T-GRID CLIP

Price *\$60 per*

TMU COUPLER & TRACK

Price *\$555*

UNISTRUT COUPLER

Price *\$170 per*

Panels

Thicc is available in a variety of acoustic felt finishes. For a complete list of finishes please visit loftwall.com/thicc. All panel finishes and designs are priced the same.

Name	Description
PET felt (AKUS-)	Sound-absorbing panel

Designs

Thicc has three different design options for all three of its sizes.



BASE



PITCH

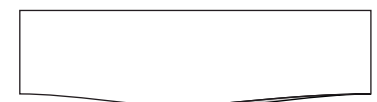

WAVE

Thin acoustic baffles

Pricing

To price Thin, select a size-based SKU and mounting method.

Typicals

Thin is available in 3 sizes, all of which use 9mm thick PET.



BA-THN-BASE-SML

Dimensions	47.5" W x 11.75" H x 1.125"
Panel(s)	(1) panel
Price	\$120 per



BA-THN-BASE-MED

Dimensions	72" W x 11.75" H x 1.125"
Panel(s)	(1) panel
Price	\$180 per



BA-THN-BASE-LRG

Dimensions	92" W x 11.75" H x 1.125"
Panel(s)	(1) panel
Price	\$240 per

Price per Sq Ft.

Often times it is simpler to price baffles by square foot. Below is a graph that illustrates the cost of baffles based on model, size, amount of baffles and baffle spacing.

Size	List Price	Length (ft)	6" Spacing	12" Spacing	24" Spacing	Price Per Square Foot
Small	\$230.00	4	\$115.00	\$57.50	\$28.75	\$57.50
Medium	\$340.00	6	\$113.33	\$56.67	\$28.33	\$56.67
Large	\$450.00	7.6	\$182.42	\$59.21	\$29.61	\$59.21

Mounting

Thin needs to be ceiling mounted with either a ceiling coupler, ceiling track or clip.



CEILING COUPLER

Price *Included*

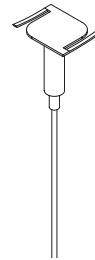

T-GRID CLIP

Price *\$60 per*

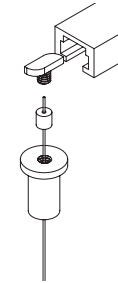

TMU COUPLER & TRACK

Price *\$555*

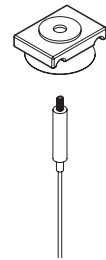

UNISTRUT COUPLER

Price *\$170 per*

Panels

Thin is available in a variety of acoustic felt finishes. For a complete list of finishes please visit loftwall.com/Thin. All panel finishes and designs are priced the same.

Name	Description
PET felt (AKUS-)	Sound-absorbing panel

Designs

Thin has three different design options for all three of its sizes.

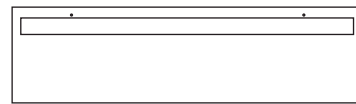

BASE

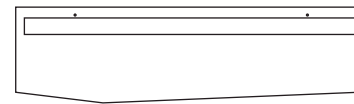

PITCH



WAVE

LOFTWALL