

Material finishes

Variety is the spice of life

LOFTWALL



Product contents



BUFFER 6
room divider



CHISEL 8
room divider



FLOX 11
room divider



FRAMEWALL 13
room divider



SPLIT 17
room divider



WAVE 20
room divider



WEAVE 22
room divider

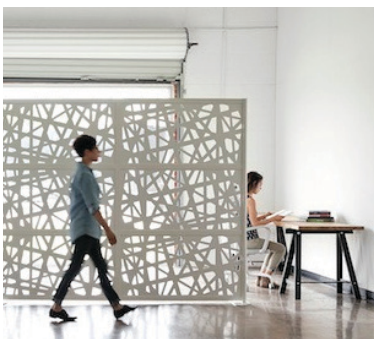

WEB 24
room divider



HEDGE 26
storage systems



SHIFT 28
storage systems



COUNTER SHIELD 30
desk divider



DESK SHIELD 32
desk divider



HIDE 34
desk divider



HITCH 36
desk divider



PARALLEL 39
desk divider



SHELTER 41
desk divider



ARBOR 43
wallcovering

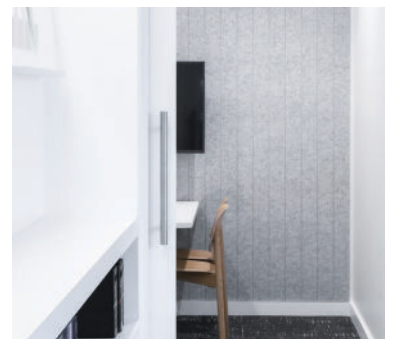

TANGO 45
wallcovering

Product contents



TEMPO WALL 47
wallcovering



GLIDE 49
architectural



HOVER 52
desk divider



PIVOT 54
desk divider



ROOMS 58
desk divider

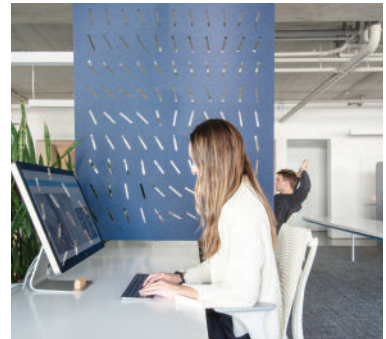

GRAVITY 61
wallcovering



LAYER 64
wallcovering



POCKET 66
wallcovering



SKY 68
acoustic baffle



TEMPO
acoustic baffle

71



THICC
acoustic baffle

74



THIN
acoustic baffle

76

OUR PRODUCTS AND MATERIALS ARE SPECIFICALLY DESIGNED & SELECTED TO PROVIDE OUR CLIENTS WITH AS MANY OPTIONS TO CREATE A SPACE THAT MEETS THEIR NEEDS. FOR THE MOST UP TO DATE INFORMATION ON OUR MATERIAL FINISHES, VISIT [LOFTWALL.COM/FINISHES](https://loftwall.com/finishes)



Buffer room divider

minimalistic partition for maximum privacy

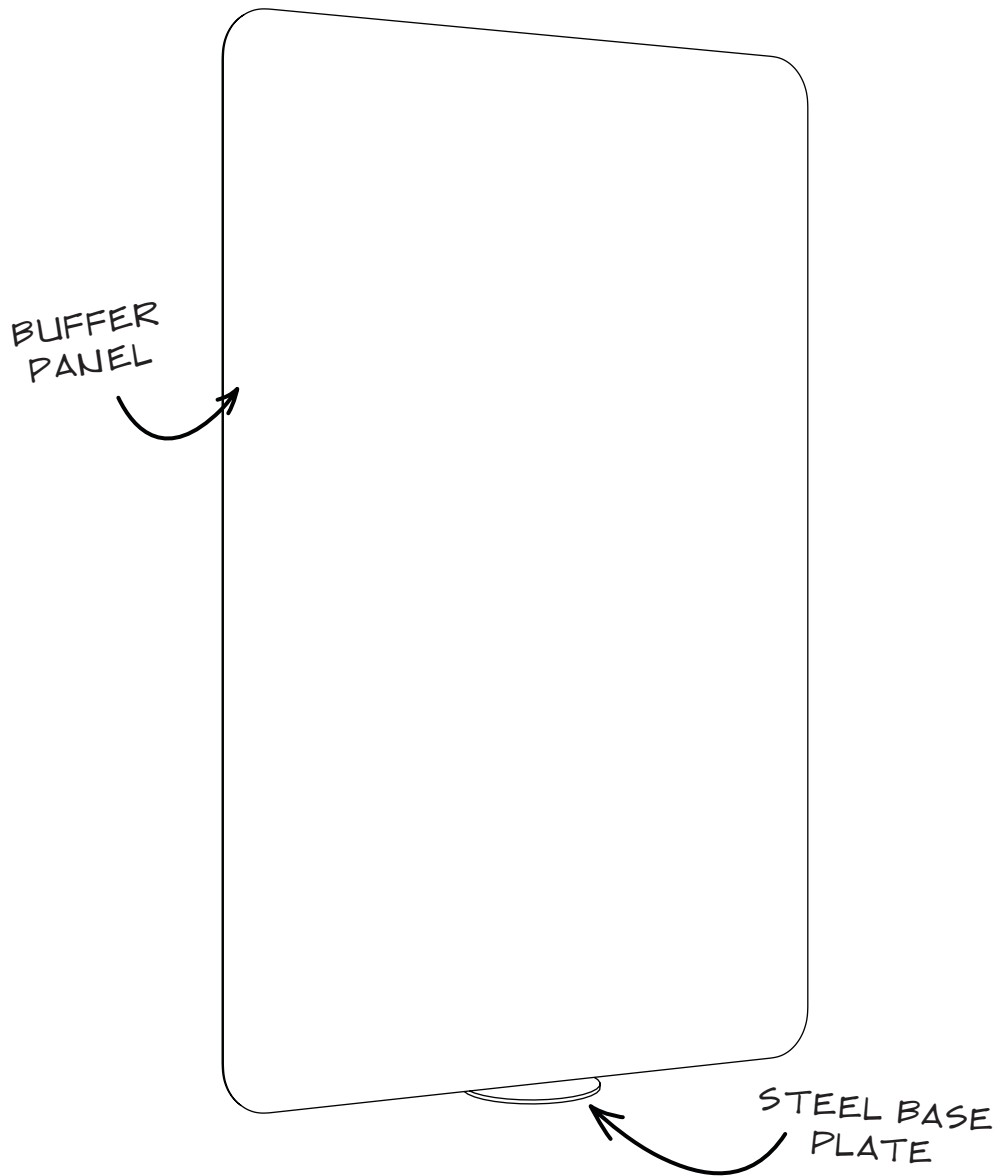

*AVAILABLE IN THREE HEIGHTS AND THREE WIDTHS

Steel Base Plate Finishes



Red



Orange



Yellow



Green



Slate Blue



Dark Blue

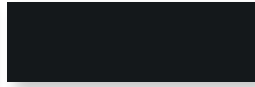

Black



Silver

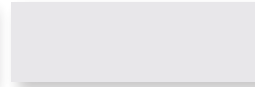

White

Buffer Panel Finishes

ACOUSTIC PET



Brick



Pumpkin Spice



Cherry



Carrot



Sunflower



Straw

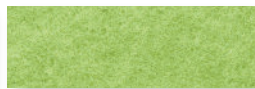

Lime



Guac



Ice



Seafoam

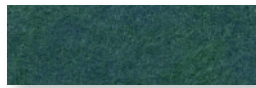

Peacock



Sapphire



Cobalt



Midnight



Grape



Bark



Concrete



Sand



Snow



Mystic



Marble



Steel



Charcoal



Raven

Chisel room divider

decrease the noise, increase the design

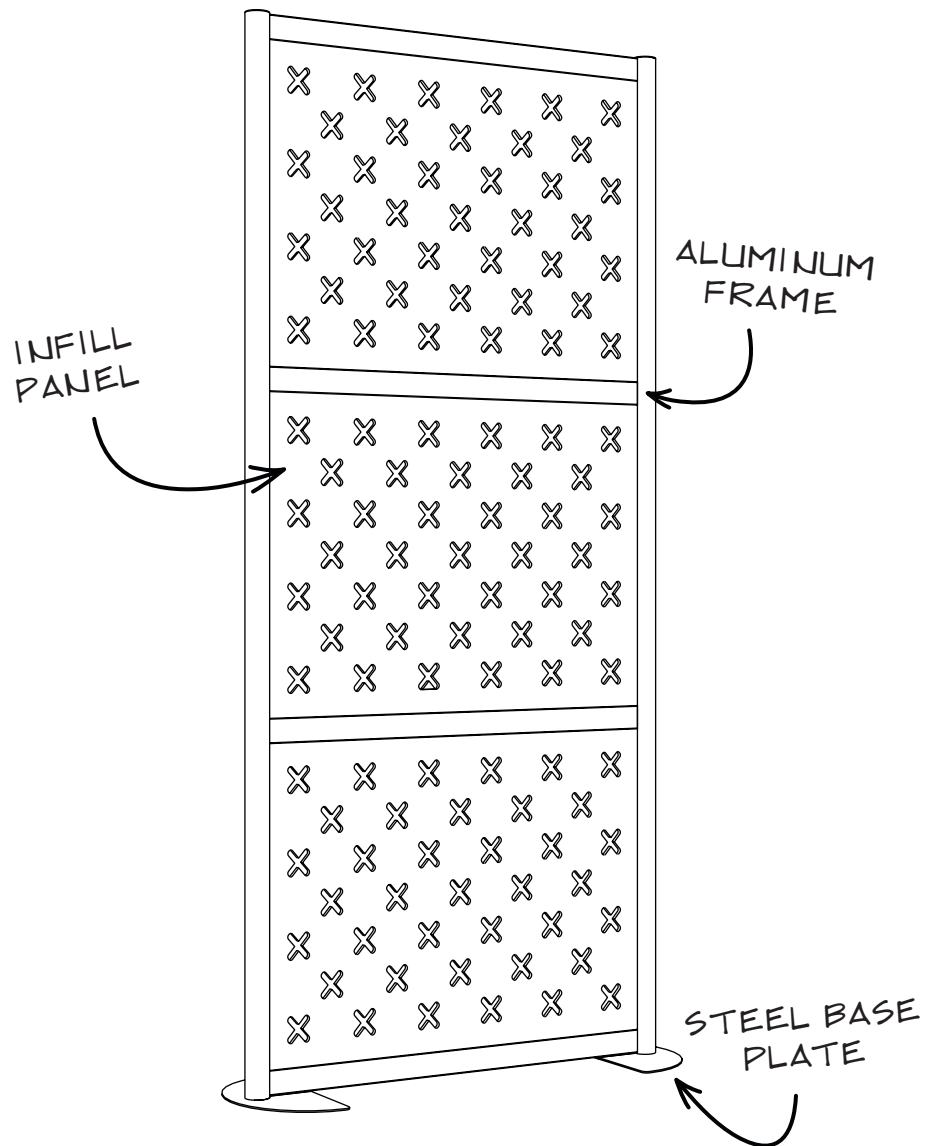

*AVAILABLE IN TWO HEIGHTS, FIVE WIDTHS
£ A VARIETY OF DESIGN STYLES

Aluminum Frame Finishes



Anodized Aluminum



Glossy White



Matte Black

Steel Base Plate Finishes



Silver



Glossy White



Matte Black

Infill Panel Finishes

ACOUSTIC PET

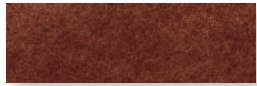

Brick



Pumpkin Spice

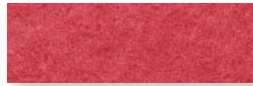

Cherry



Carrot



Sunflower



Straw



Lime



Guac



Ice



Seafoam



Peacock



Sapphire



Cobalt



Midnight



Grape



Bark



Concrete



Sand

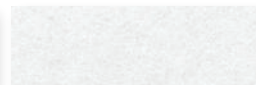

Snow



Mystic



Marble



Steel



Charcoal



Raven

Cut Design Patterns

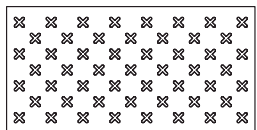

Multiply

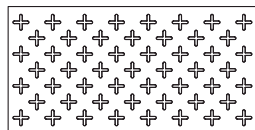

Plus

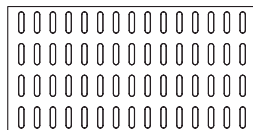

Pills

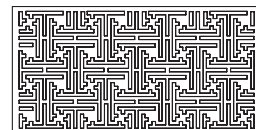

Maze

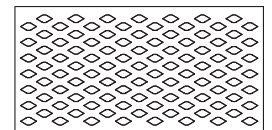

Grate

Cut Design Patterns

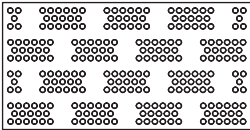

Brick

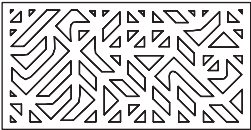

Transit

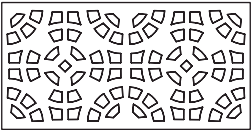

Aztec

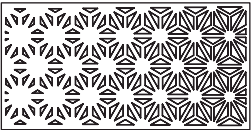

Kaleidoscope

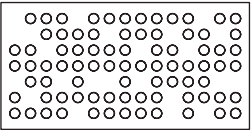

Circles

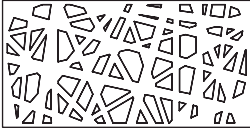

Web

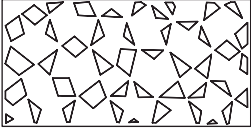

Fractal

*Chisel panels are only available in 2' x 2', 2' x 3' and 2' x 4'

Flox room divider

for when you need flexible sound control

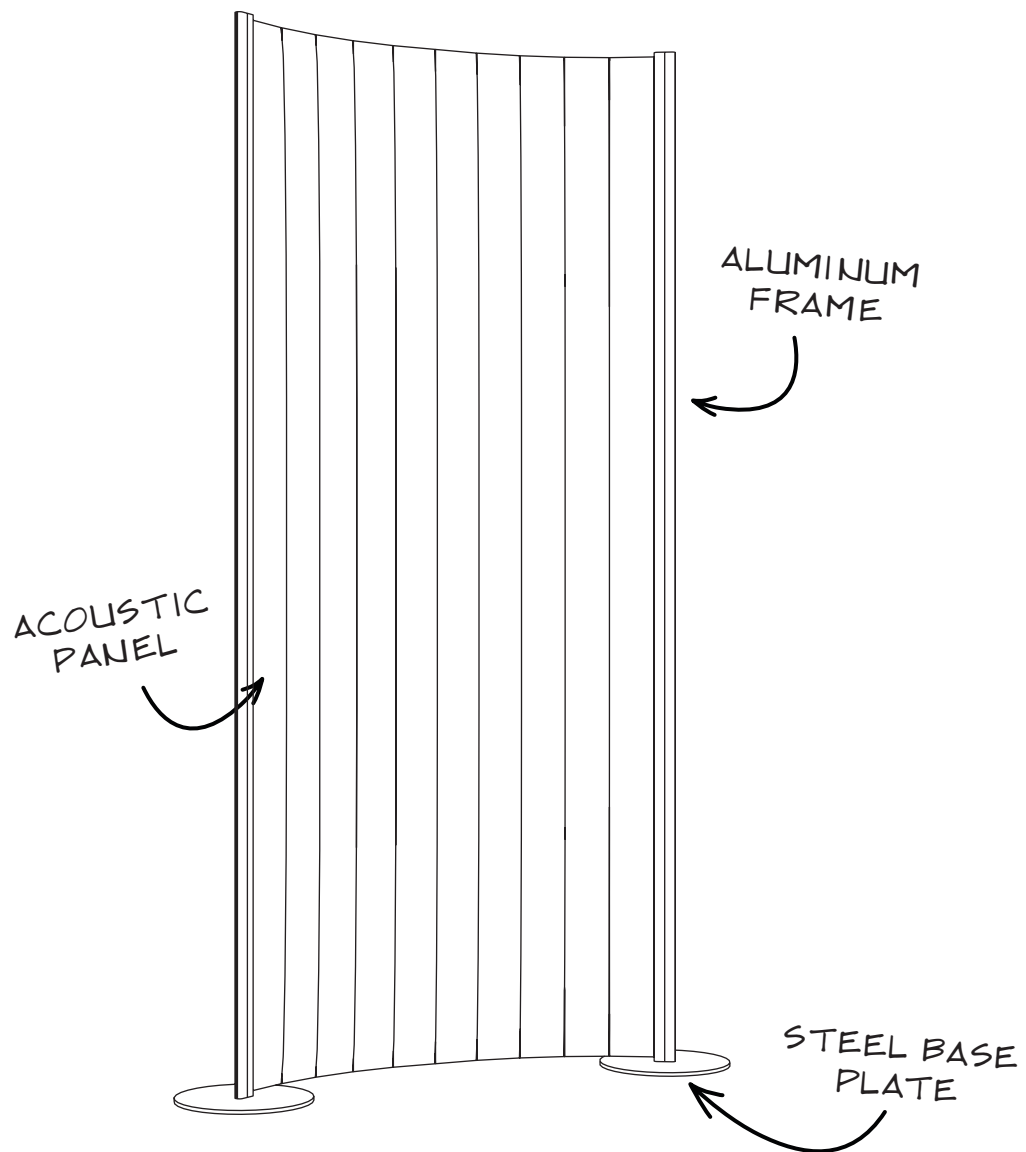

*AVAILABLE IN ONLY ONE HEIGHT AND ONE WIDTH
BUT CAN BE LINKED WITH OTHER FLOX

Aluminum Frame Finishes



Anodized Aluminum

Glossy White

Matte Black

Steel Base Plate Finishes



Anodized Aluminum

Glossy White

Matte Black

Acoustic Panel Finishes

FLOX



Feather

Linen

Slate

Fossil

Moss

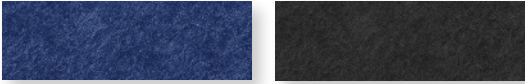

Marine

Coal

Framework room divider

for when you need to divide and conquer

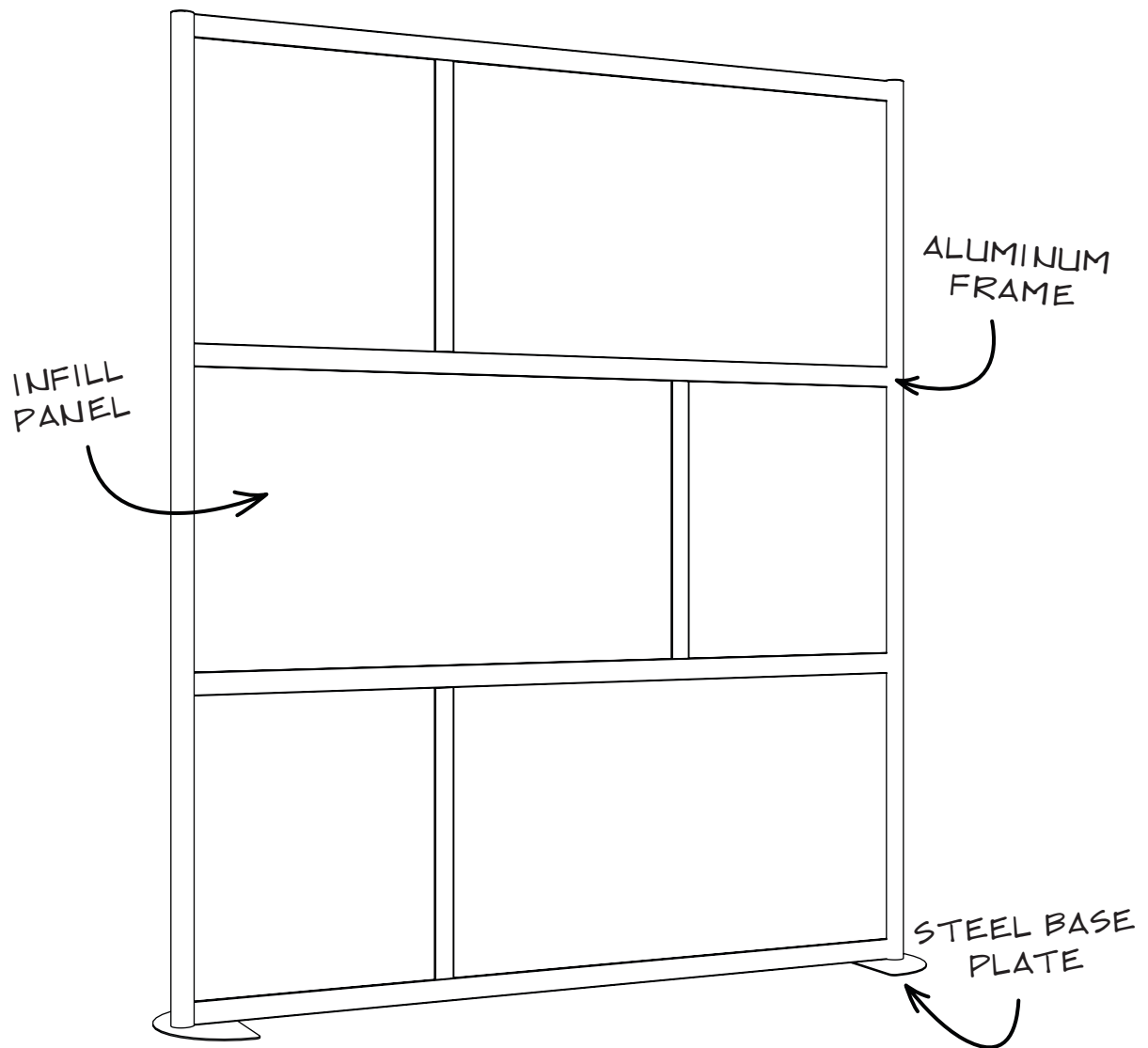

*AVAILABLE IN TWO HEIGHTS, FIVE WIDTHS
& A VARIETY OF DESIGN STYLES

Aluminum Frame Finishes



Anodized Aluminum

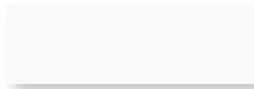

Glossy White



Matte Black

Steel Base Plate Finishes



Anodized Aluminum



Glossy White



Matte Black

Infill Panel Finishes

LAMINATE



Maroon



Teal



Navy



Slate Blue



Gray

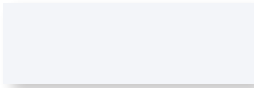

White

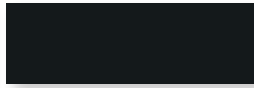

Black

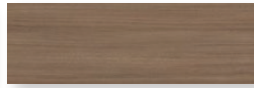

Walnut

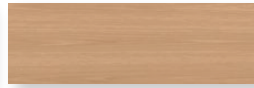

Oak



Elm

BLOX



Tomato Red



Electric Green



Emerald Green



Spruce Blue



True Blue



Navy

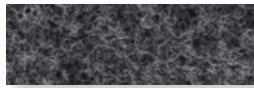

Charcoal



Medium Gray

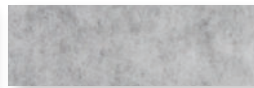

Light Gray

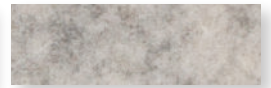

Almost White

*Blox is made of premium polyester fibers** Only available in 2' x 2' and 2' x 4' panels

ACOUSTIC PET



Brick



Pumpkin Spice



Cherry



Carrot



Sunflower



Straw



Lime



Guac



Ice



Seafoam

Infill Panel Finishes

ACOUSTIC PET (CONTINUED)

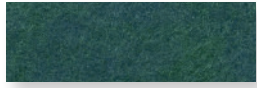

Peacock



Sapphire

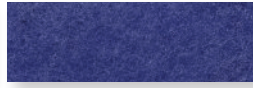

Cobalt

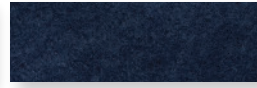

Midnight



Grape



Bark



Concrete



Sand

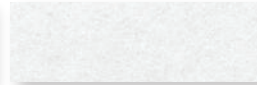

Snow



Mystic



Marble



Steel



Charcoal

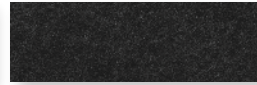

Raven

WRITABLE

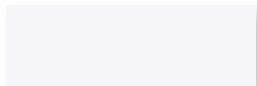

Non-magnetic Dry Erase

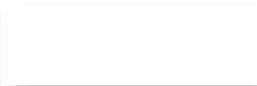

Magnetic Dry Erase

TRANSLUCENT

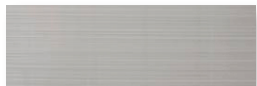

Twinwall Clear

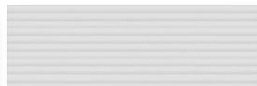

Twinwall White

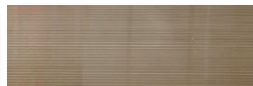

Twinwall Smoke



Frosted Acrylic

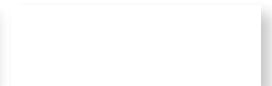

Clear Acrylic



Smoked Acrylic

SPECIALTY PANEL FINISHES



Pegboard



COM Textile



Custom Logo

Infill Panel Finishes

ACOUSTIC PET (CONTINUED)

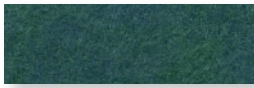

Peacock



Sapphire



Cobalt



Midnight



Grape



Bark



Concrete



Sand



Snow



Mystic



Marble



Steel



Charcoal



Raven

TRANSLUCENT

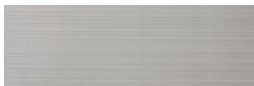

Twinwall Clear

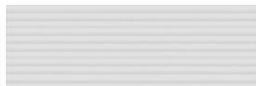

Twinwall White

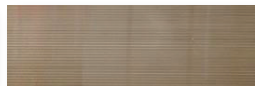

Twinwall Smoke



Frosted Acrylic

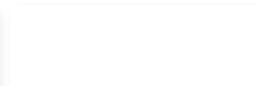

Clear Acrylic



Smoked Acrylic

SPECIALTY PANEL FINISHES



Pegboard



COM Textile



Custom Logo

Split room divider

light on hardware, heavy on design

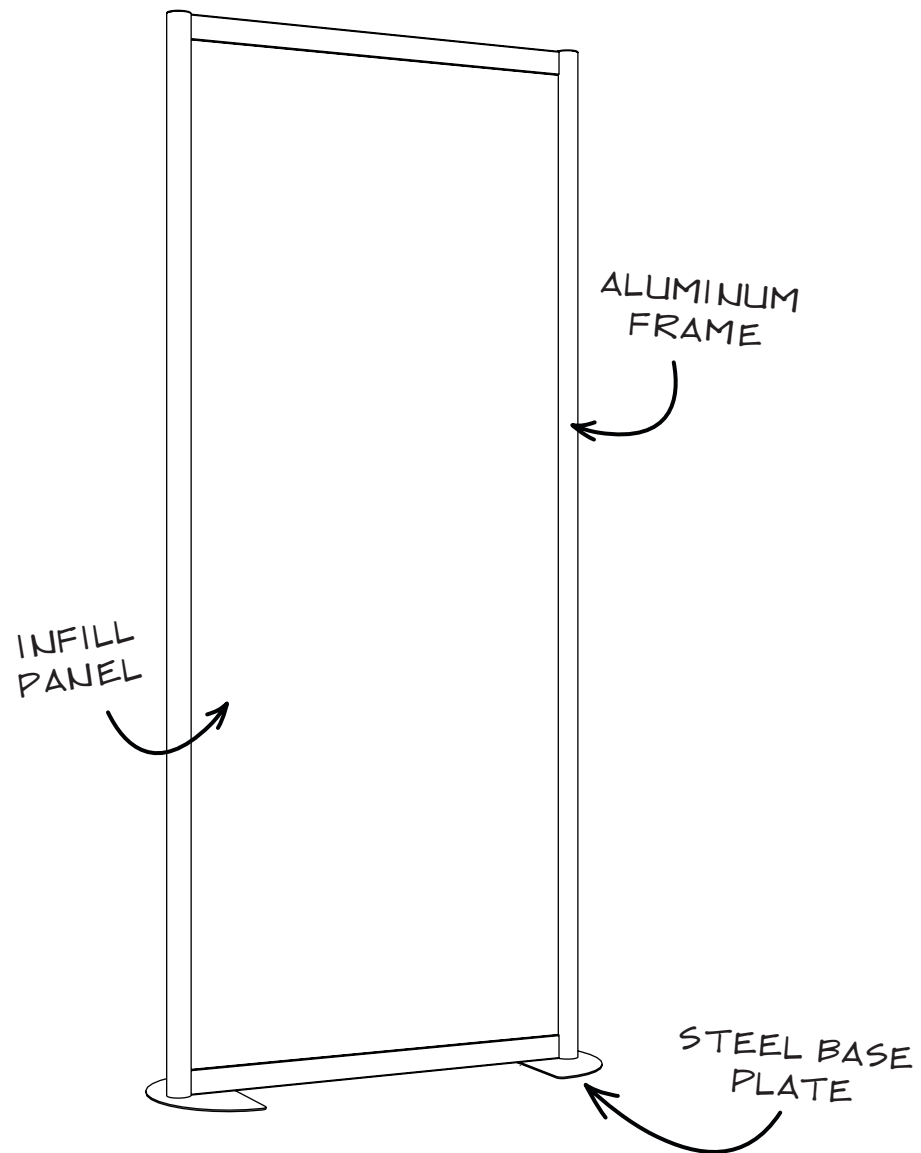

*AVAILABLE IN TWO HEIGHTS AND FOUR WIDTHS

Aluminum Frame Finishes



Anodized Aluminum

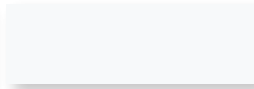

Glossy White



Matte Black

Steel Base Plate Finishes



Anodized Aluminum



Glossy White



Matte Black

Infill Panel Finishes

LAMINATE



Maroon



Teal



Navy



Slate Blue



Gray

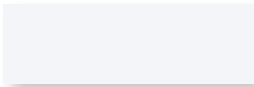

White



Black



Walnut



Oak



Elm

ACOUSTIC PET



Brick



Pumpkin Spice



Cherry



Carrot



Sunflower



Straw



Lime



Guac



Ice



Seafoam



Peacock



Sapphire



Cobalt



Midnight



Grape



Bark



Concrete



Sand



Snow



Mystic



Marble



Steel



Charcoal



Raven

Infill Panel Finishes

WRITABLE

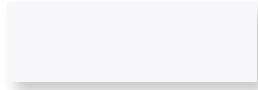

Non-magnetic Dry Erase

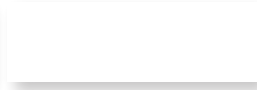

Magnetic Dry Erase

TRANSLUCENT



Twinwall Clear

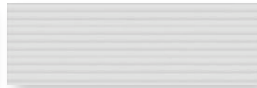

Twinwall White

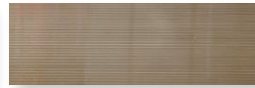

Twinwall Smoke



Frosted Acrylic

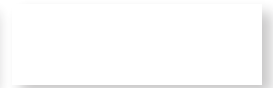

Clear Acrylic



Smoked Acrylic

SPECIALTY PANEL FINISHES



Custom Logo

Wave room divider

divide a space + add texture

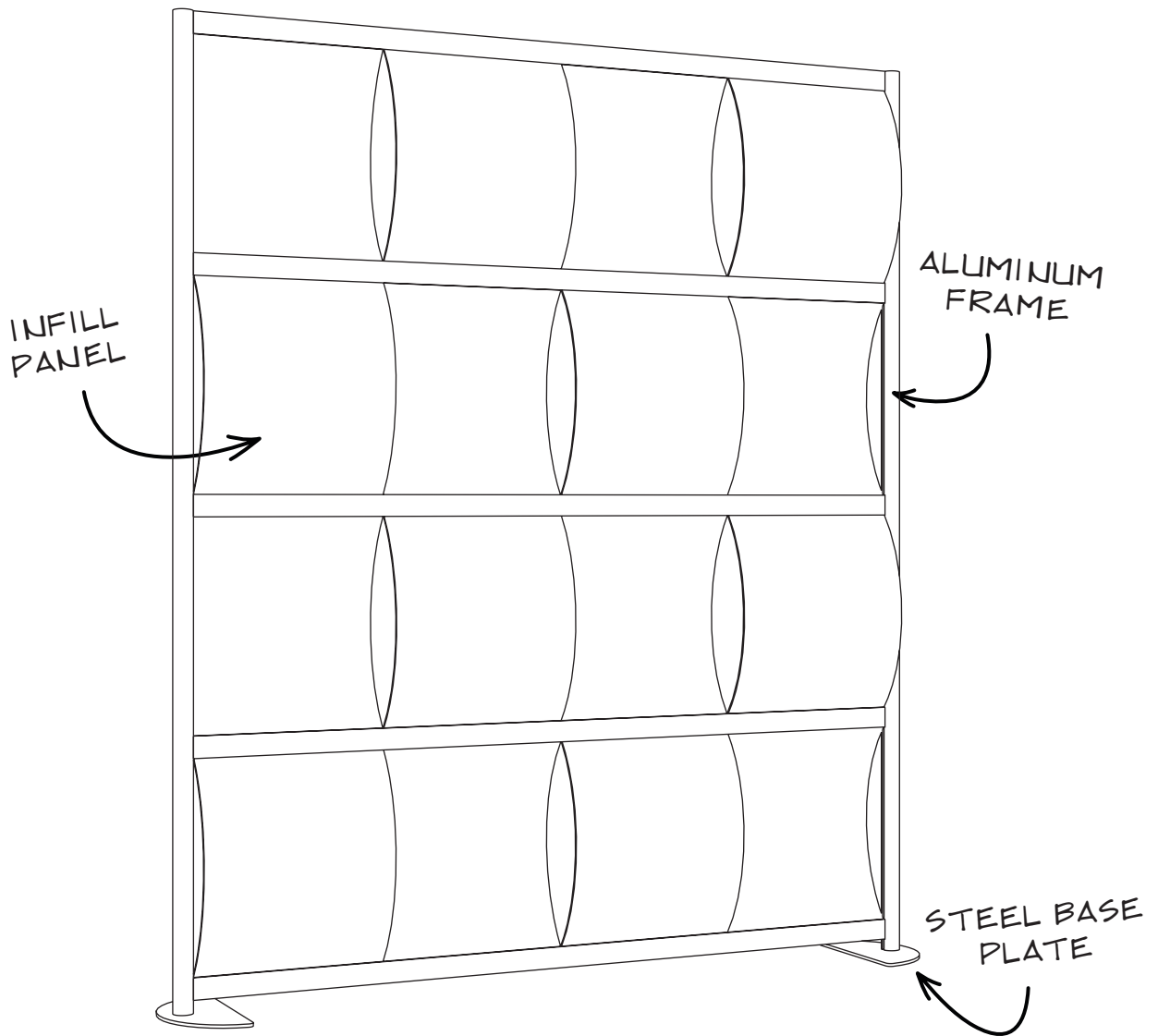

*AVAILABLE IN ONE STANDARD HEIGHT AND
THREE STANDARD WIDTHS

Aluminum Frame Finishes



Anodized Aluminum

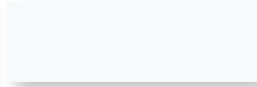

Glossy White



Matte Black

Steel Base Plate Finishes



Anodized Aluminum

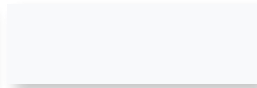

Glossy White



Matte Black

Infill Panel Finishes

WAVE PANEL



Gray

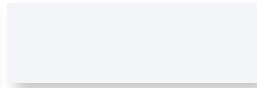

White

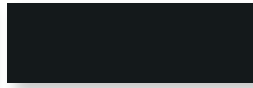

Black

Weave room divider

wrap your space in more than just quiet

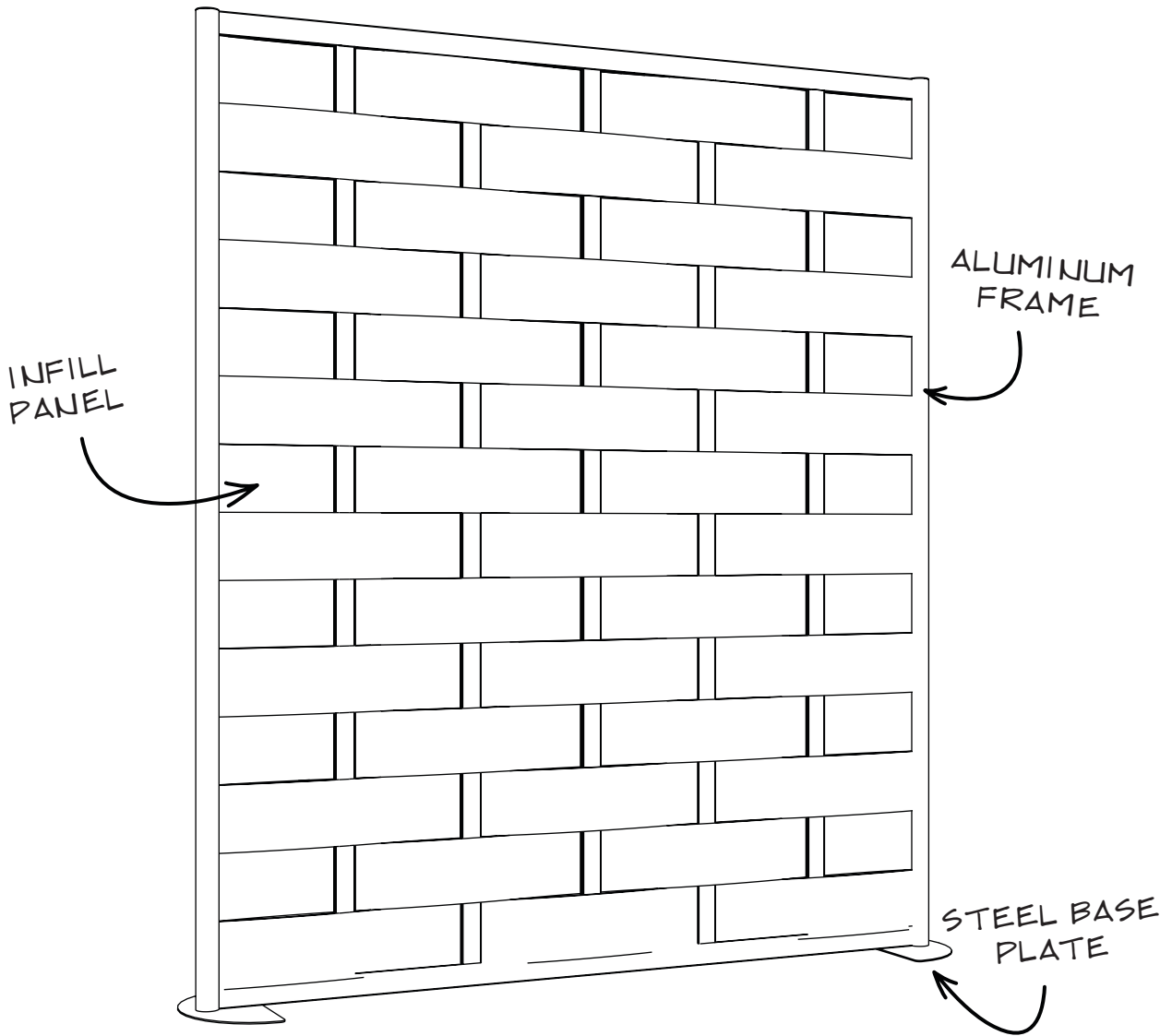

*AVAILABLE IN TWO HEIGHTS AND THREE WIDTHS

Aluminum Frame Finishes



Anodized Aluminum

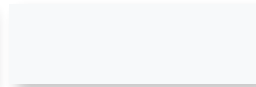

Glossy White



Matte Black

Steel Base Plate Finishes



Anodized Aluminum



Glossy White



Matte Black

Infill Panel Finishes

ACOUSTIC PET



Brick



Pumpkin Spice



Cherry



Carrot



Sunflower



Straw



Lime



Guac



Ice



Seafoam



Peacock



Sapphire



Cobalt



Midnight



Grape



Bark



Concrete



Sand

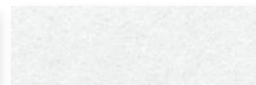

Snow



Mystic



Marble



Steel



Charcoal



Raven

Web room divider

for when you need to let some light in

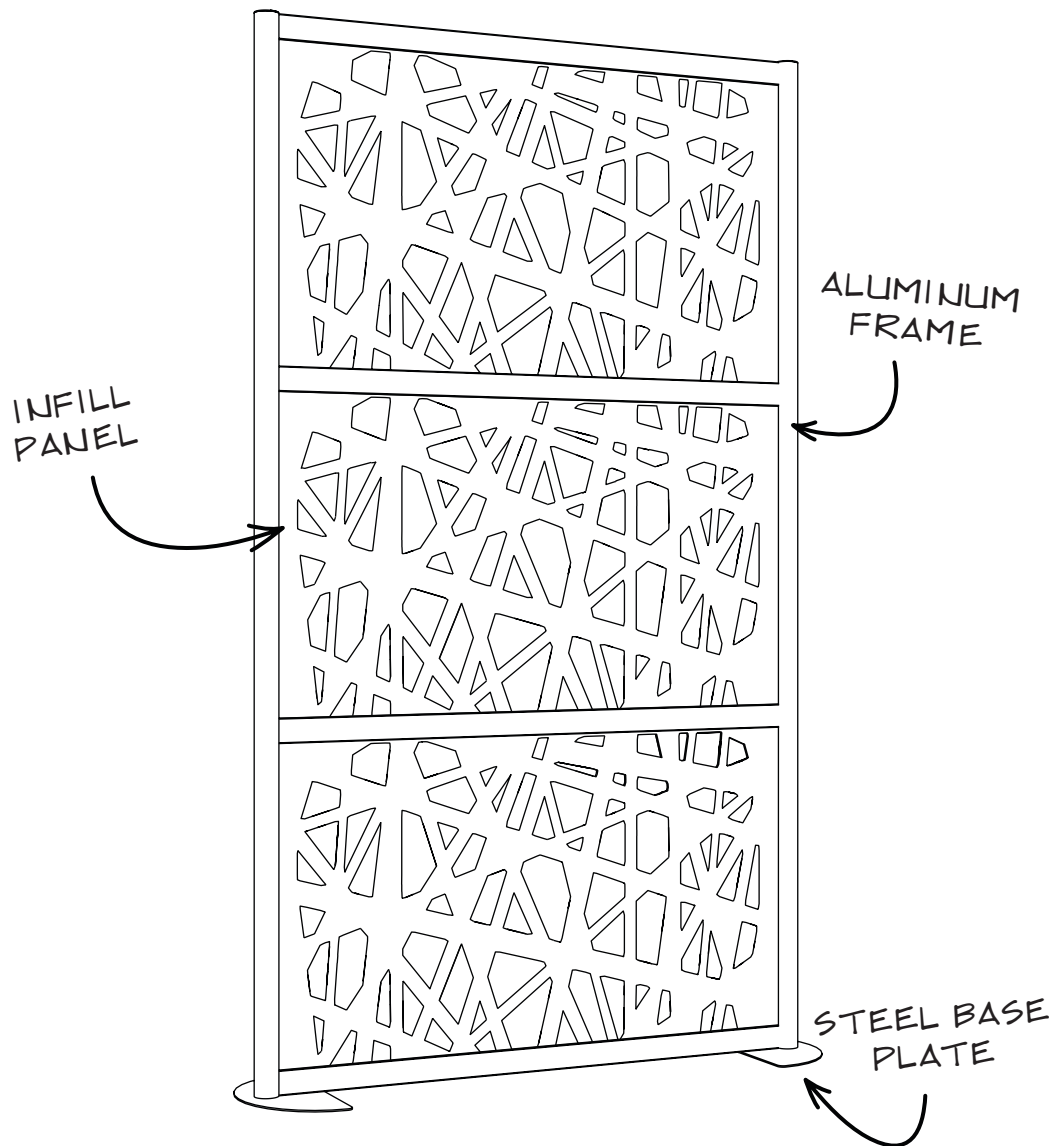

*AVAILABLE IN TWO HEIGHTS, FIVE WIDTHS
& A VARIETY OF DESIGN STYLES

Aluminum Frame Finishes



Anodized Aluminum



Glossy White



Matte Black

Steel Base Plate Finishes



Anodized Aluminum



Glossy White



Matte Black

Infill Panel Finishes

HDPE



Gray

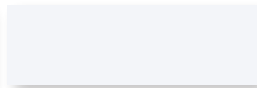

White



Black

Hedge storage systems

modern shelving where privacy meets storage

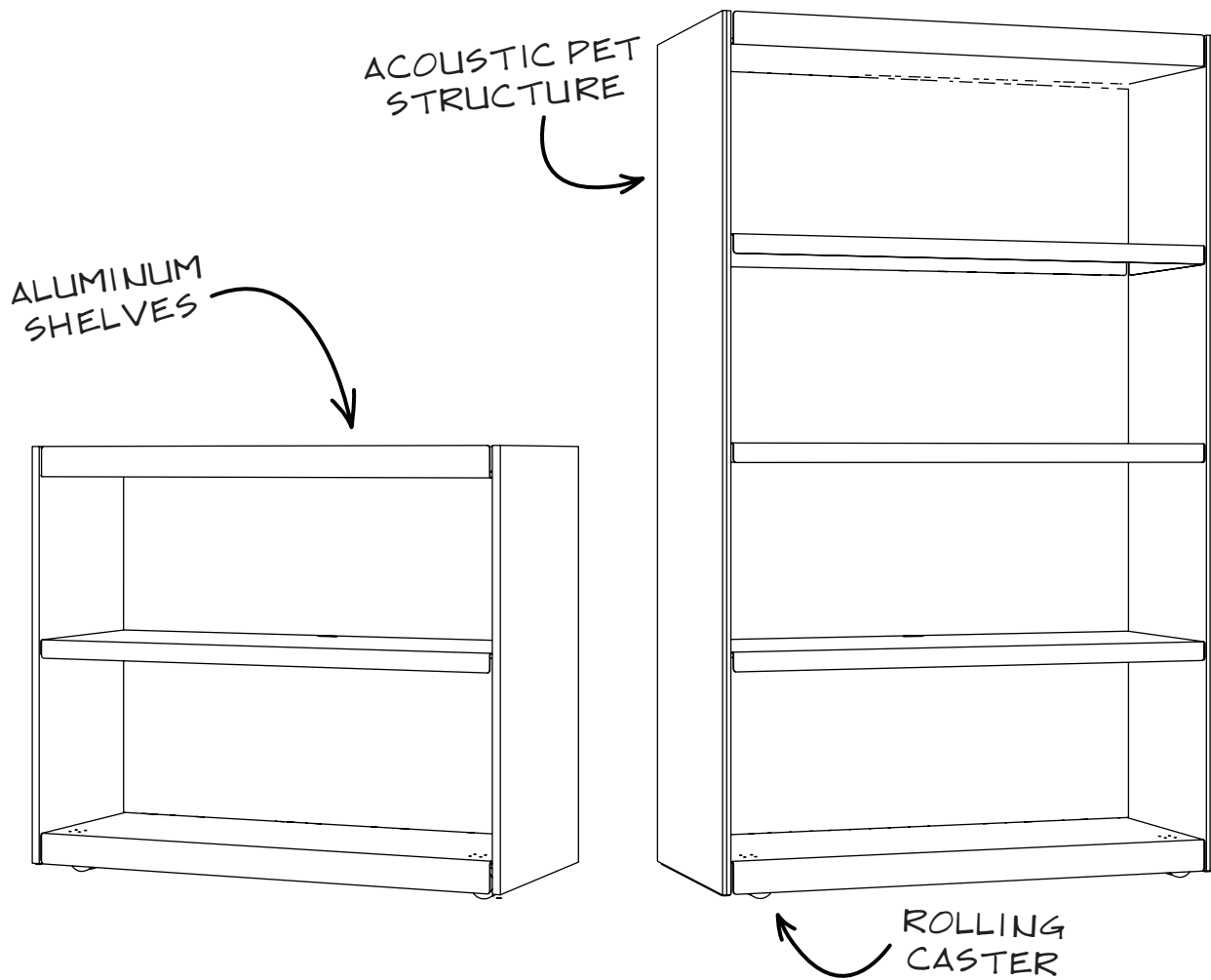

*AVAILABLE IN TWO HEIGHTS WITH THE OPTION TO ADD A WHITE BOARD, MOUNTED TV AND DOORS.

Aluminum Shelf Finishes



Glossy White



Matte Black

Acoustic PET Structure Finishes

ACOUSTIC PET



Marble



Charcoal

Acoustic PET Door Finishes

ACOUSTIC PET



Brick



Pumpkin Spice



Cherry



Carrot



Sunflower



Straw



Lime



Guac



Ice



Seafoam

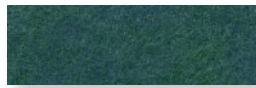

Peacock



Sapphire



Cobalt



Midnight



Grape



Bark



Concrete



Sand



Snow



Mystic



Marble



Steel



Charcoal



Raven

Shift room divider

modern shelving where privacy meets storage

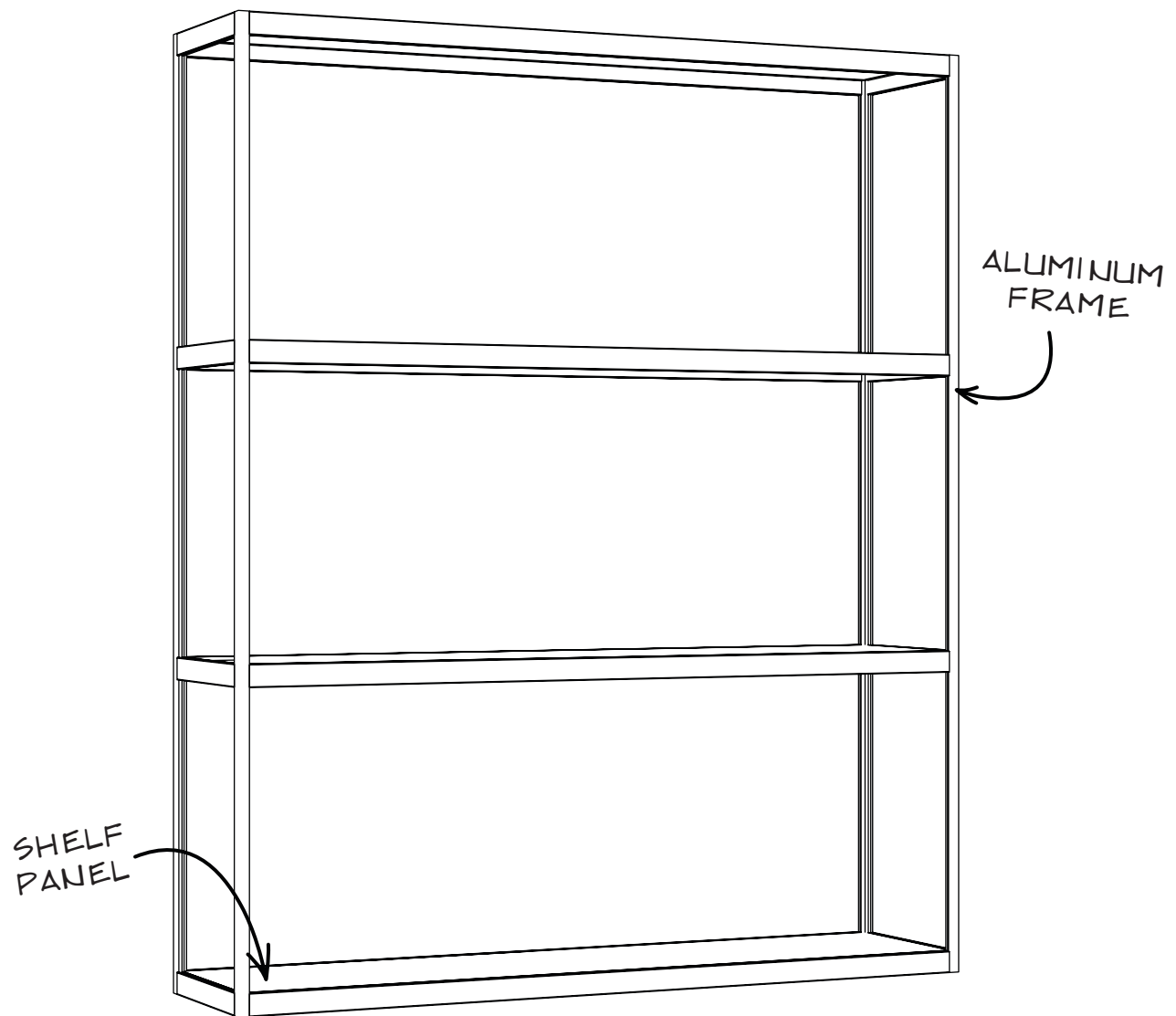

*AVAILABLE IN TWO HEIGHTS, TWO WIDTHS
& A VARIETY OF PANEL CONFIGURATIONS

Aluminum Frame Finishes



Anodized Aluminum

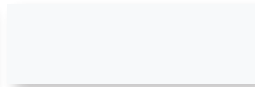

Glossy White



Matte Black

Shelf Finishes

LAMINATE



Walnut



Oak



Elm

Infill Panel Finishes

LAMINATE



Maroon



Teal



Navy



Slate Blue



Gray

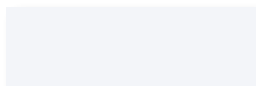

White



Black



Walnut



Oak



Elm

BLOX



Tomato Red



Electric Green



Emerald Green



Spruce Blue



True Blue

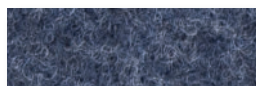

Navy



Charcoal



Medium Gray

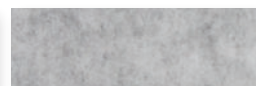

Light Gray



Almost White

*Blox is made of premium polyester fibers** Only available in 2' x 2' and 2' x 4' panels

ACOUSTIC PET



Brick



Pumpkin Spice



Cherry



Carrot



Sunflower



Straw



Lime



Guac



Ice

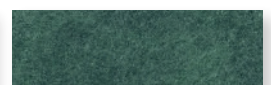

Seafoam

Counter Shield desk divider

a family of healthcare-grade sneeze guards

Lite Style

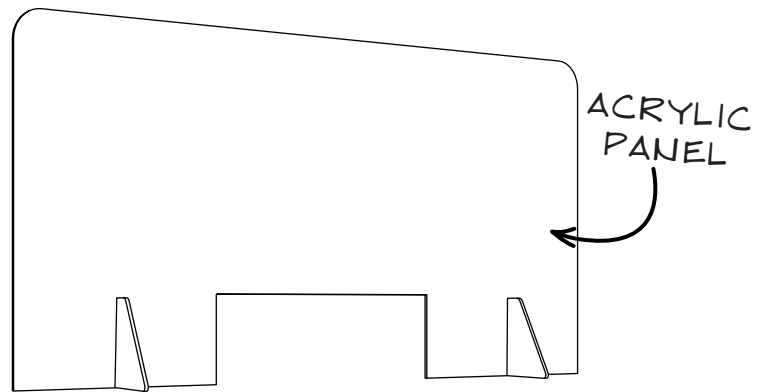

Basic Style

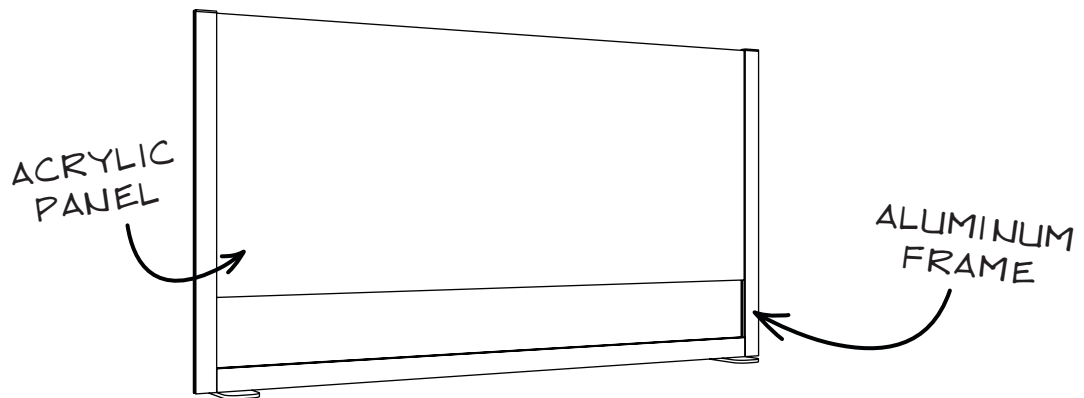

Classic Style

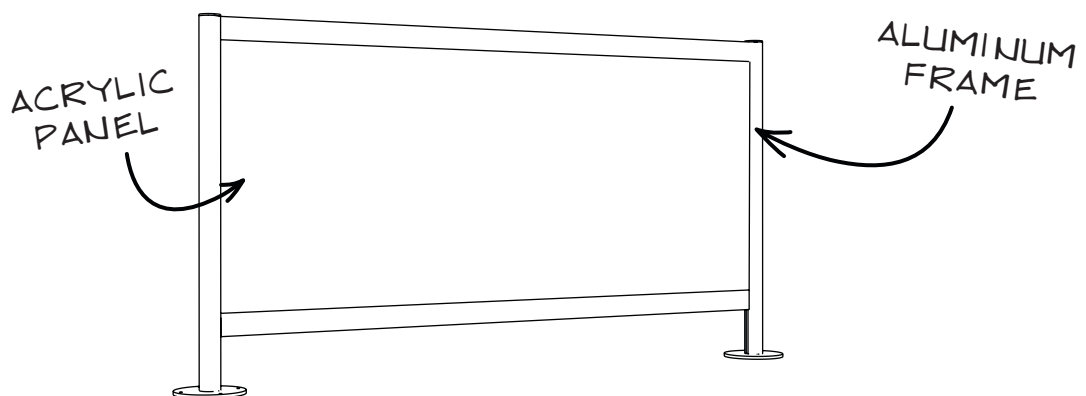

Wrap Style

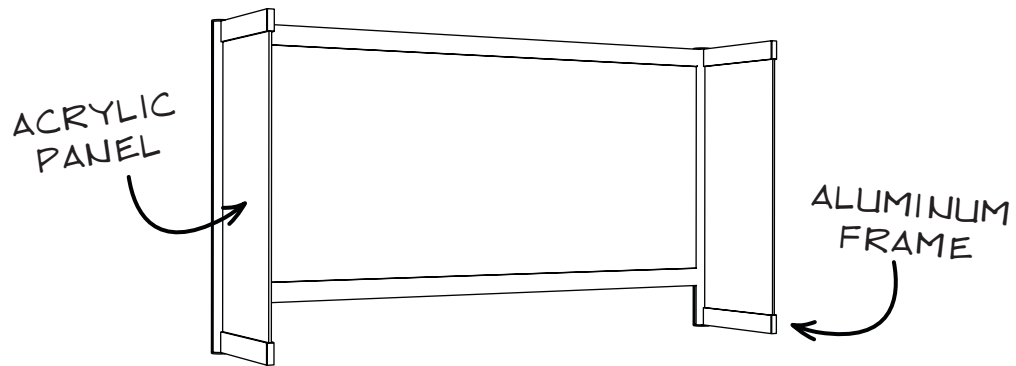

*ALL COUNTER SHIELDS ARE AVAILABLE IN TWO WIDTHS,
SMALL & LARGE

Aluminum Frame Finishes



Anodized Aluminum

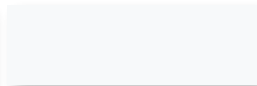

Glossy White



Matte Black

Acrylic Panel Finishes

TRANSLUCENT

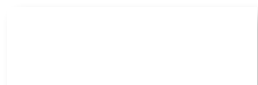

Clear Acrylic



*Frosted Acrylic



Smoked Acrylic

*Frosted & Smoked Acrylic is available on all Counter Shield styles except for Lite

Desk Shield desk divider

a refuge from distractions and germs

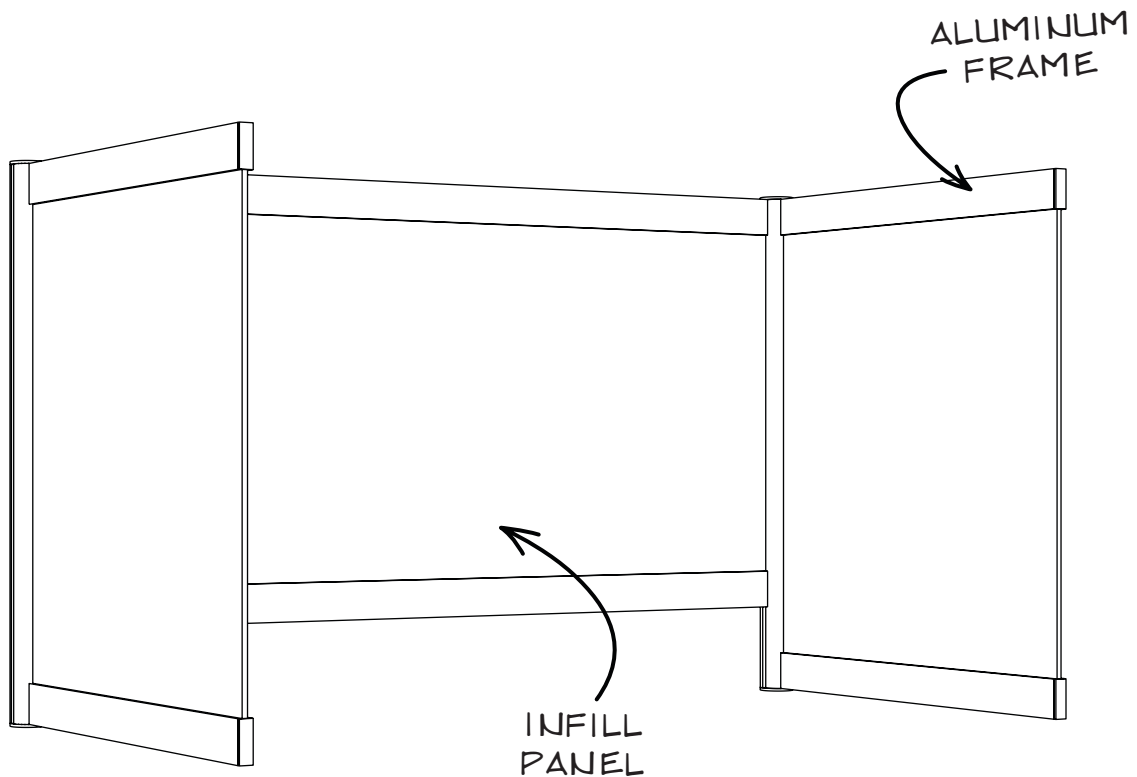

*AVAILABLE IN ONE HEIGHT OPTION, THREE WIDTHS
AND TWO DEPTHS

Aluminum Frame Finishes



Anodized Aluminum

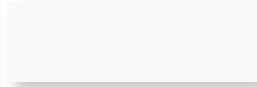

Glossy White



Matte Black

*Brackets are made of steel

Infill Panel Finishes

TRANSLUCENT



Frosted Acrylic

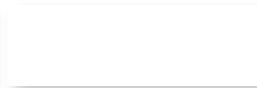

Clear Acrylic



Smoked Acrylic

Hide desk divider

a hassle-free way to escape from chaos

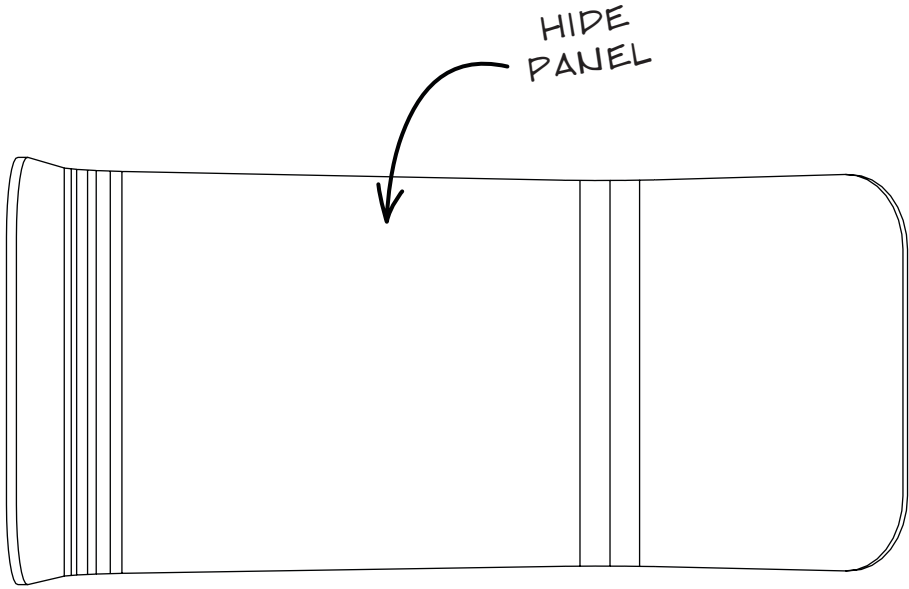

*AVAILABLE IN ONLY ONE SIZE

Hide Panel Finishes

ACOUSTIC PET



Hitch desk divider

tie privacy to any workstation

Single Hitch

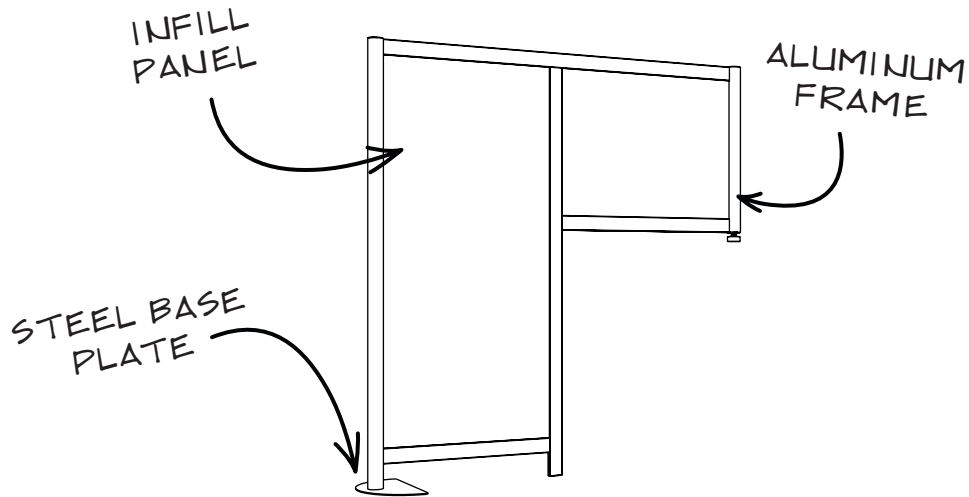

*AVAILABLE IN ONE HEIGHT AND TWO WIDTHS

Double Hitch

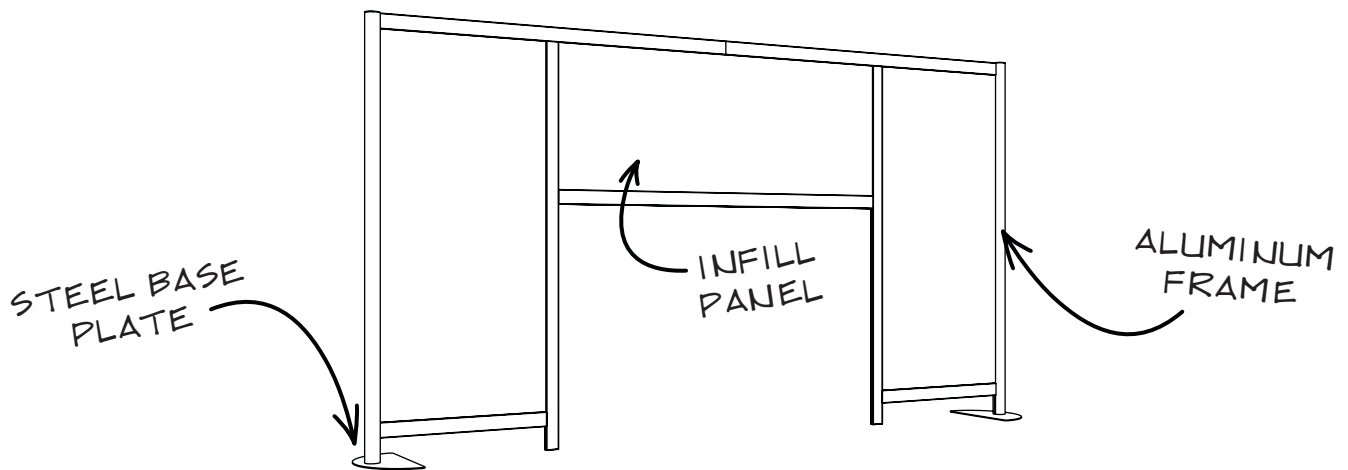

*AVAILABLE IN ONE HEIGHT AND FOUR WIDTHS

Aluminum Frame Finishes



Anodized Aluminum

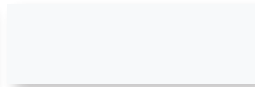

Glossy White



Matte Black

Steel Base Plate Finishes



Anodized Aluminum



Glossy White



Matte Black

Infill Panel Finishes

LAMINATE



Maroon



Teal



Navy



Slate Blue



Gray

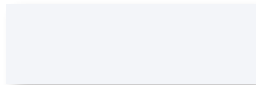

White

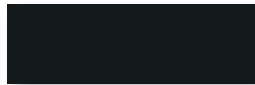

Black



Walnut



Oak



Elm

ACOUSTIC PET



Brick



Pumpkin Spice



Cherry



Carrot



Sunflower



Straw



Lime



Guac



Ice



Seafoam



Peacock



Sapphire



Cobalt



Midnight



Grape



Bark



Concrete



Sand



Snow



Mystic



Marble



Steel



Charcoal



Raven

Infill Panel Finishes

ACOUSTIC PET (CONTINUED)

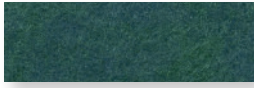

Peacock



Sapphire

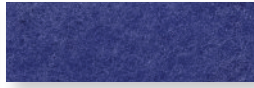

Cobalt



Midnight

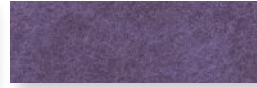

Grape



Bark



Concrete



Sand



Snow



Mystic



Marble



Steel



Charcoal

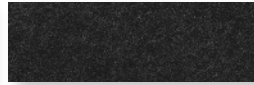

Raven

WRITABLE

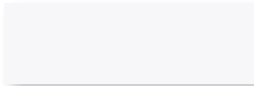

Non-magnetic Dry Erase

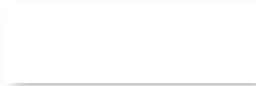

Magnetic Dry Erase

TRANSLUCENT

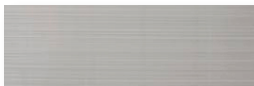

Twinwall Clear

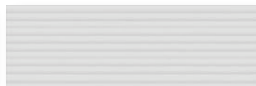

Twinwall White

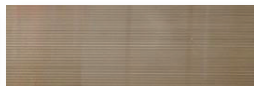

Twinwall Smoke



Frosted Acrylic

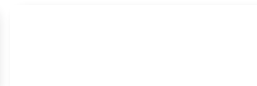

Clear Acrylic



Smoked Acrylic

SPECIALTY PANEL FINISHES



Pegboard



COM Textile



Custom Logo

Parallel desk divider

the most flexible way to divide your desk

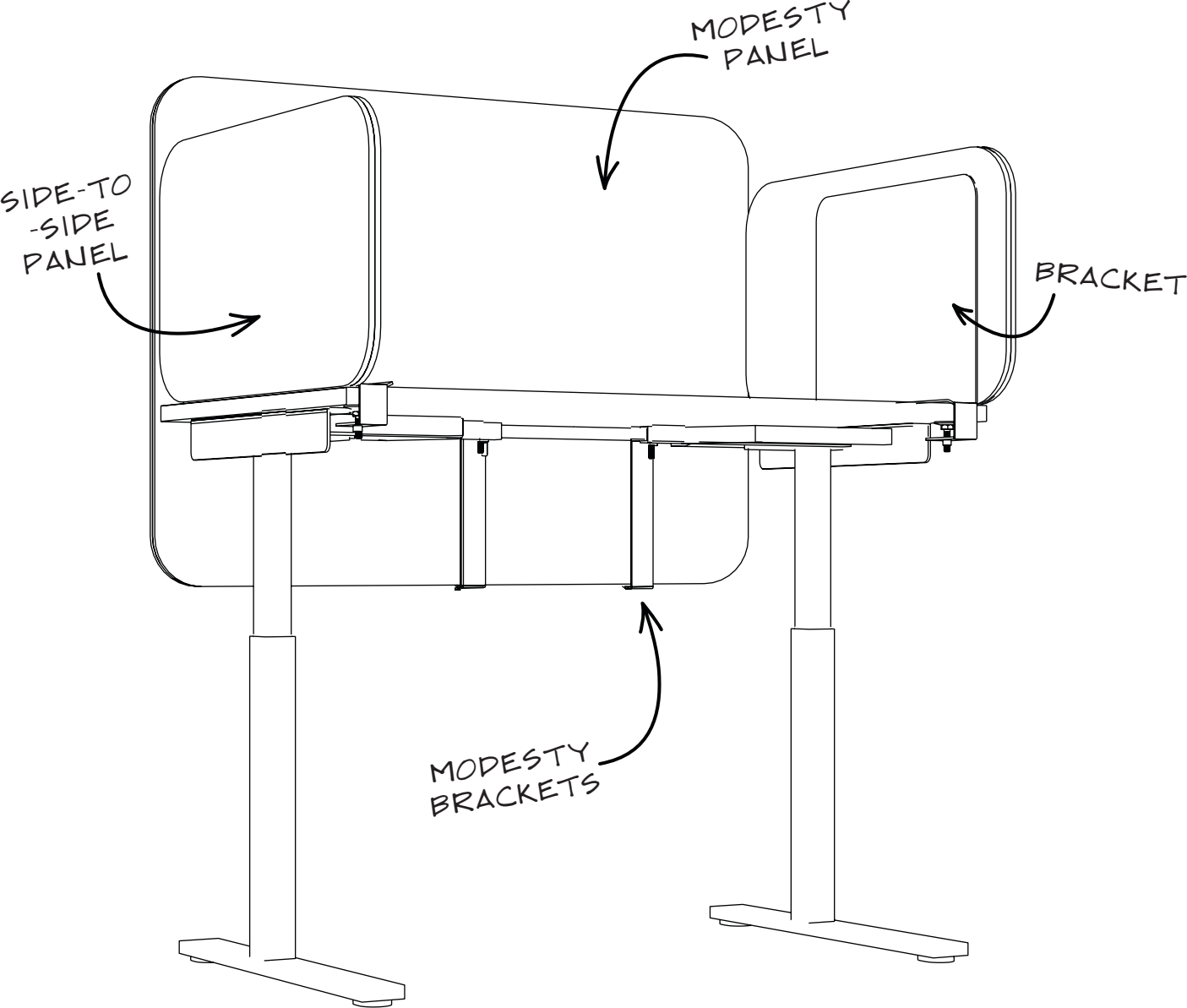

*DESK NOT INCLUDED

Bracket Finishes

WRITABLE

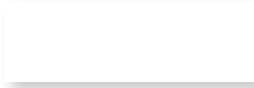

Magnetic Dry Erase

Modesty Bracket Finishes



Glossy White

Panel Finishes

ACOUSTIC PET



Brick



Pumpkin Spice



Cherry



Carrot



Sunflower



Straw



Lime



Guac



Ice

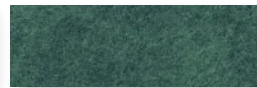

Seafoam

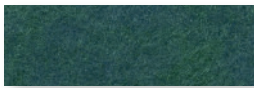

Peacock



Sapphire



Cobalt



Midnight



Grape



Bark



Concrete



Sand

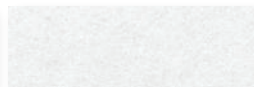

Snow



Mystic



Marble



Steel



Charcoal



Raven

Shelter desk divider

a safe place to touchdown and work

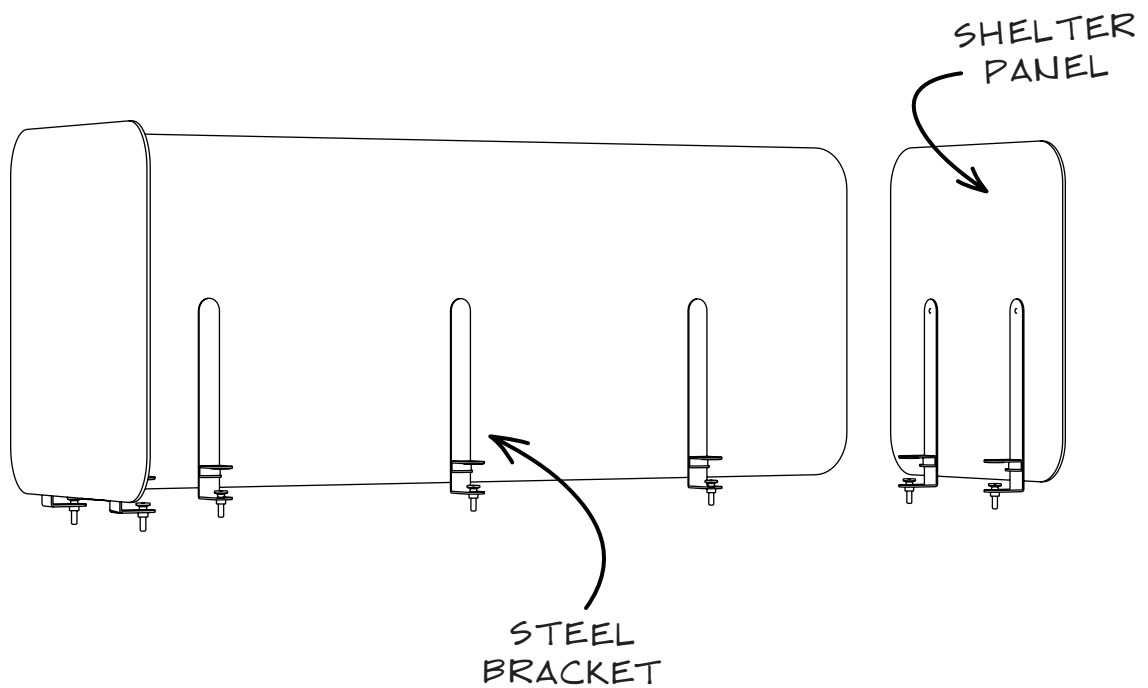

*AVAILABLE IN TWO HEIGHTS AND A VARIETY OF WIDTHS AND DEPTHS: AS WELL AS MOUNTING ORIENTATIONS.

Steel Bracket Finishes



Silver

Shelter Panel Finishes

ACOUSTIC PET



Brick



Pumpkin Spice



Cherry



Carrot



Sunflower



Straw



Lime



Guac



Ice

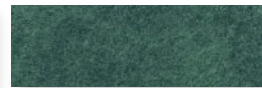

Seafoam



Peacock



Sapphire



Cobalt



Midnight



Grape



Bark



Concrete



Sand

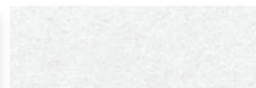

Snow



Mystic



Marble



Steel



Charcoal



Raven

TRANSLUCENT



Frosted Acrylic

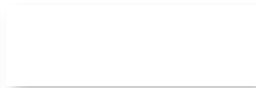

Clear Acrylic



Smoked Acrylic

Arbor wall coverings

Beautiful, sound-dampening slatted wood wall panels

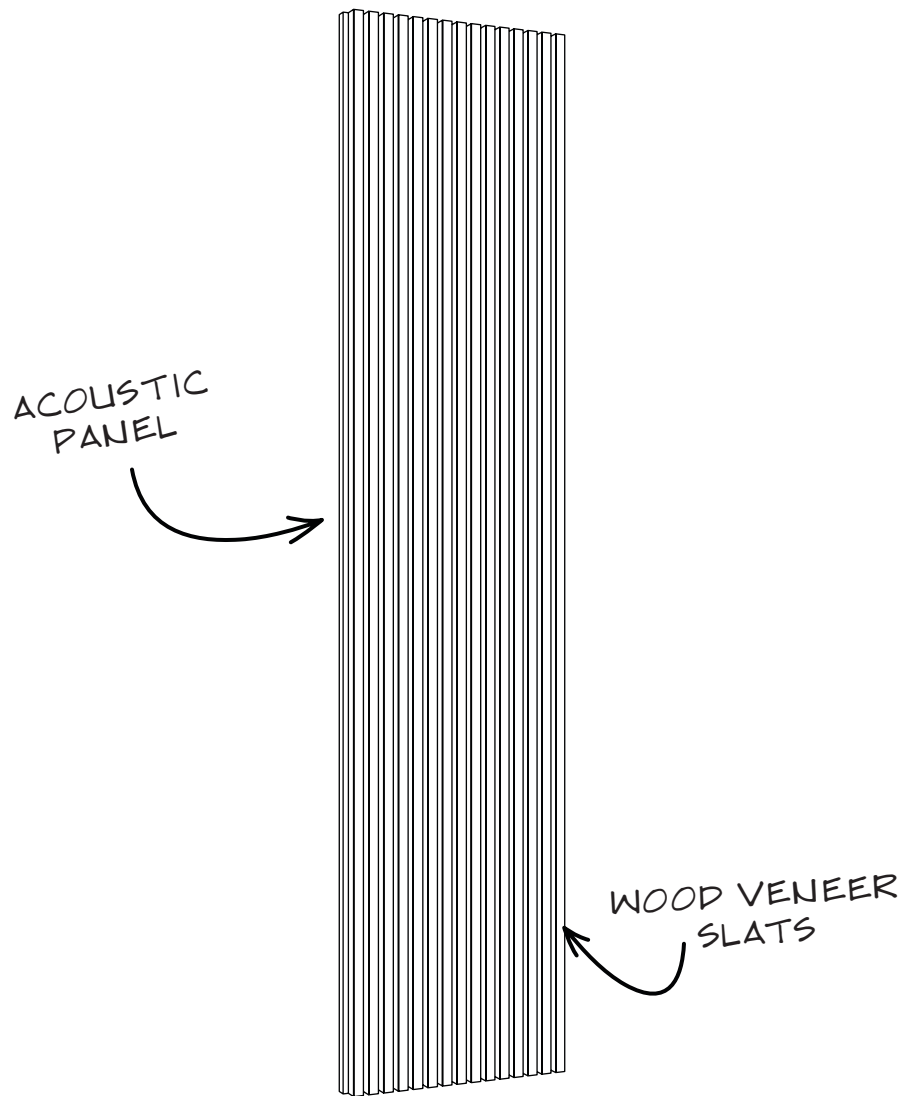

*AVAILABLE IN TWO HEIGHTS AND TWO DEPTHS

Wood Veneer Slat Finishes

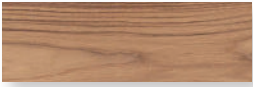

Teak



Oak

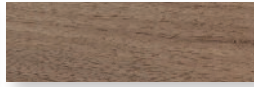

Walnut

Acoustic Panel Finishes

ACOUSTIC PET

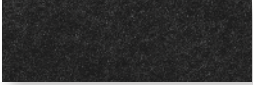

Raven

RESERVE Collection

Wood Veneer Slat Finishes



Black Oak



Dark Walnut



Gray Oak



Smoked Oak



Washed Oak

Acoustic Panel Finishes

ACOUSTIC PET



Raven



Steel



Marble



Midnight

Tango wall coverings

sound-reducing modular wall tiles

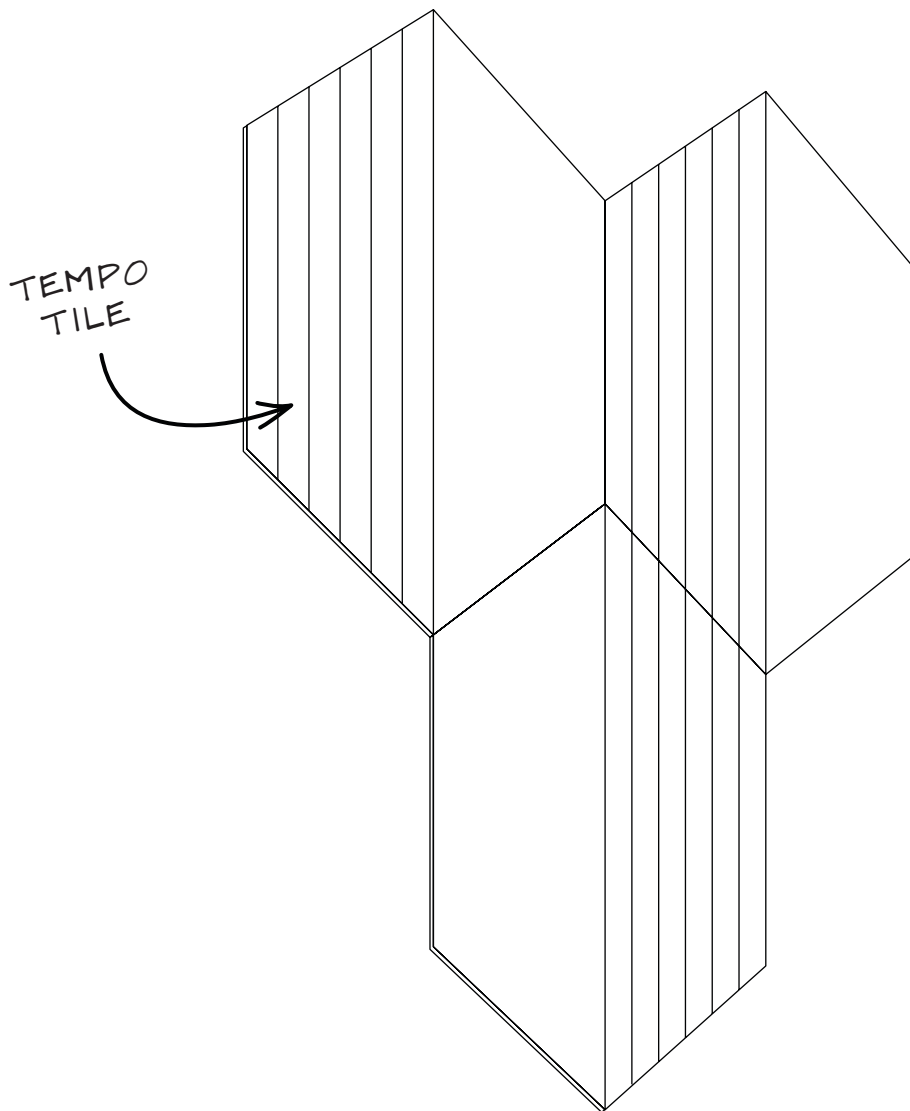

*AVAILABLE IN EIGHT SHAPES, TWO SIZES AND THREE STYLES

Tango Tile Finishes

ACOUSTIC PET



Tango Tile Cut Designs and Sizes

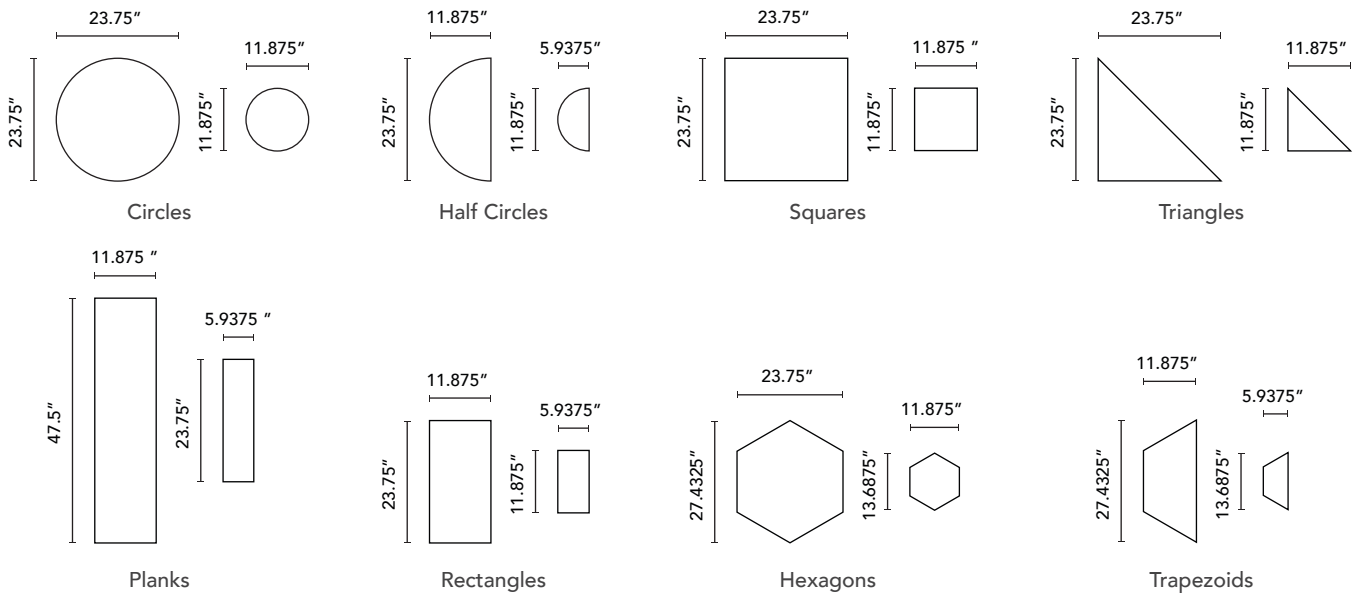

Tempo Wall wall coverings

turn down the volume, with style

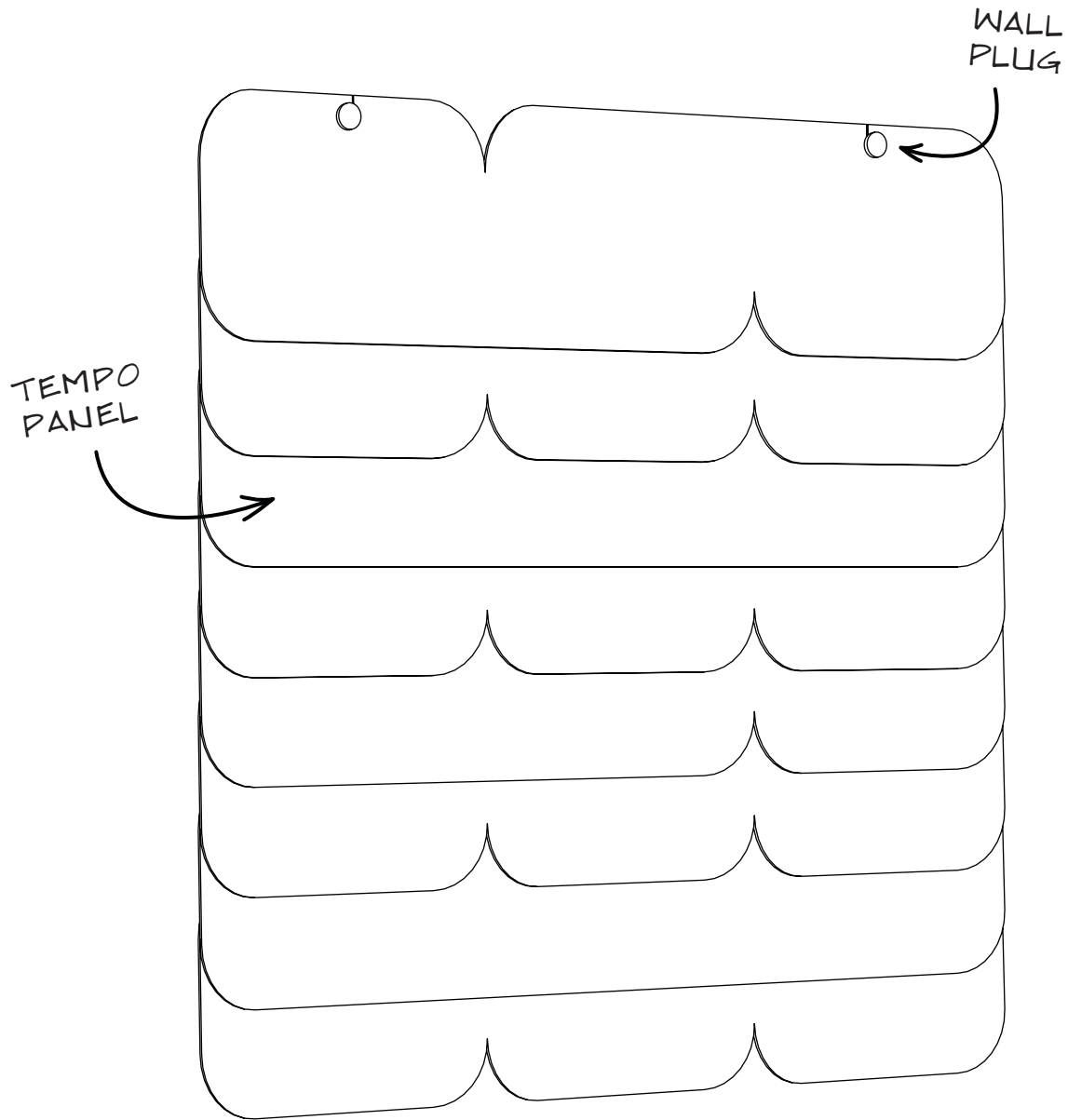

*AVAILABLE IN TWELVE PANEL STYLES AND
SOLD IN 4' X 4' GRID SYSTEMS

Wall Plug Finishes



Cork

Tempo Panel Finishes

ACOUSTIC PET

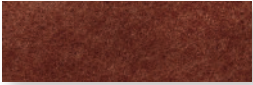

Brick



Pumpkin Spice

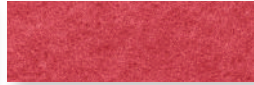

Cherry



Carrot



Sunflower



Straw



Lime



Guac



Ice

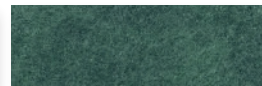

Seafoam



Peacock



Sapphire



Cobalt



Midnight



Grape



Bark



Concrete



Sand

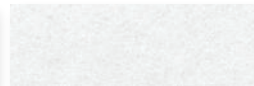

Snow



Mystic



Marble



Steel



Charcoal



Raven

Tempo Panel Designs



Turn 1



Turn 2

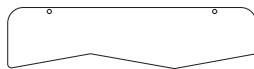

Turn 3



Tilt 1



Tilt 2

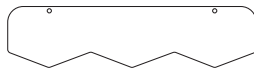

Tilt 3



Tab 1



Tab 2



Tab 3



Tide 1



Tide 2



Tide 3

Glide architectural

sliding privacy, concealed magic

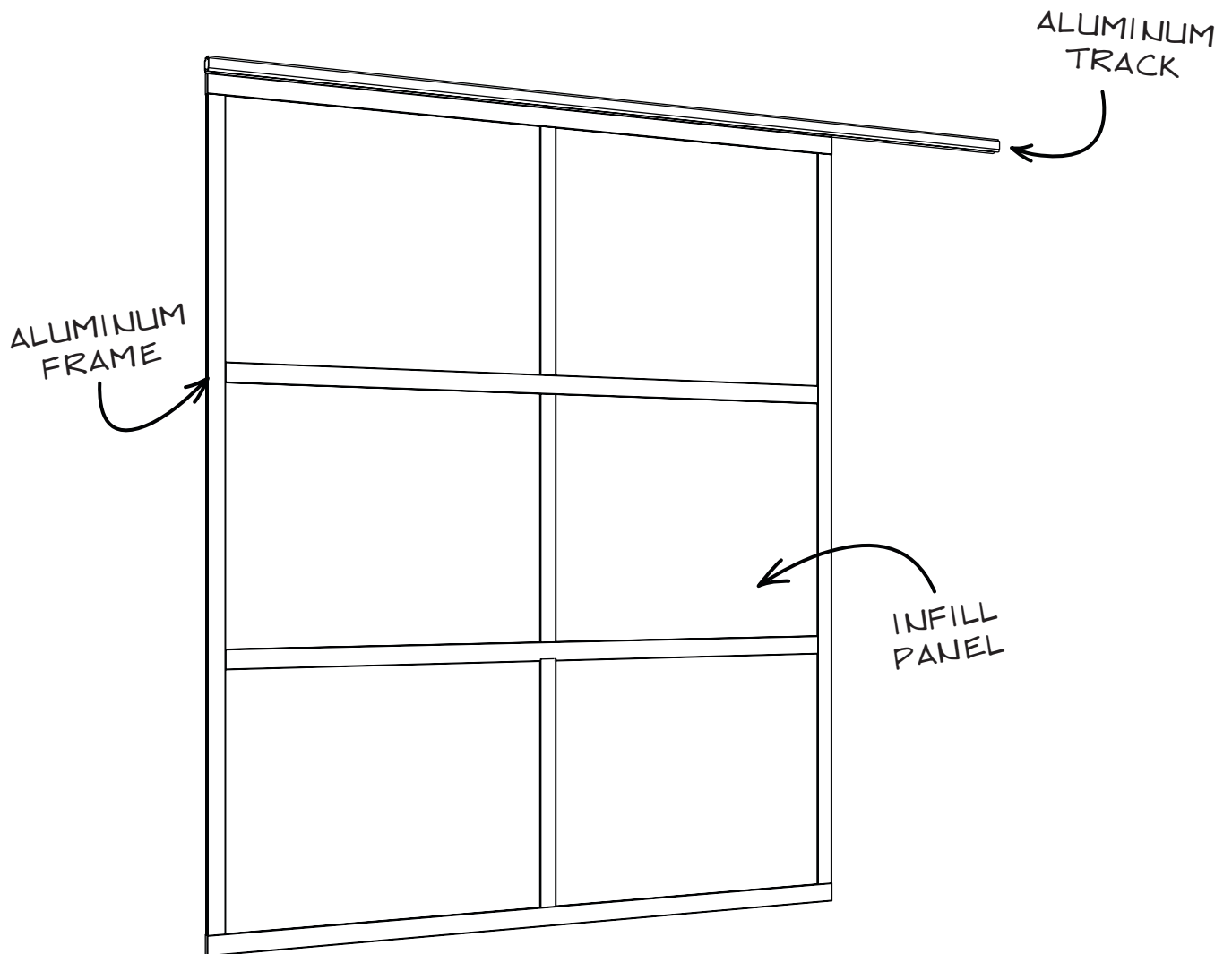

*AVAILABLE IN THREE HEIGHTS, TWO WIDTHS

Aluminum Frame Finishes



Anodized Aluminum

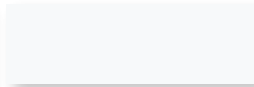

Glossy White



Matte Black

Infill Panel Finishes

LAMINATE



Maroon



Teal



Navy



Slate Blue



Gray

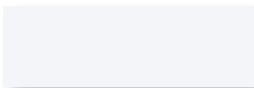

White



Black

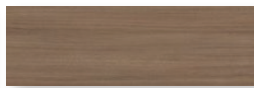

Walnut

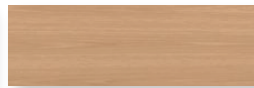

Oak



Elm

ACOUSTIC PET



Brick



Pumpkin Spice



Cherry



Carrot



Sunflower



Straw



Lime



Guac



Ice

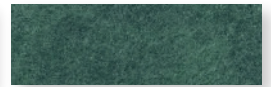

Seafoam

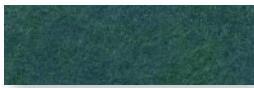

Peacock



Sapphire



Cobalt



Midnight



Grape



Bark



Concrete



Sand



Snow



Mystic



Marble



Steel



Charcoal



Raven

TRANSLUCENT



Twinwall Clear

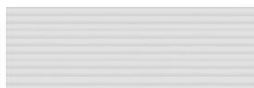

Twinwall White

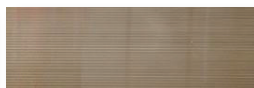

Twinwall Smoke



Frosted Acrylic

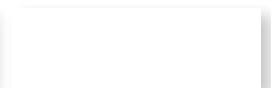

Clear Acrylic

Infill Panel Finishes



Smoked Acrylic

SPECIALTY PANEL FINISHES



Pegboard



COM Textile



Custom Logo

Hover architectural

when full coverage privacy is needed

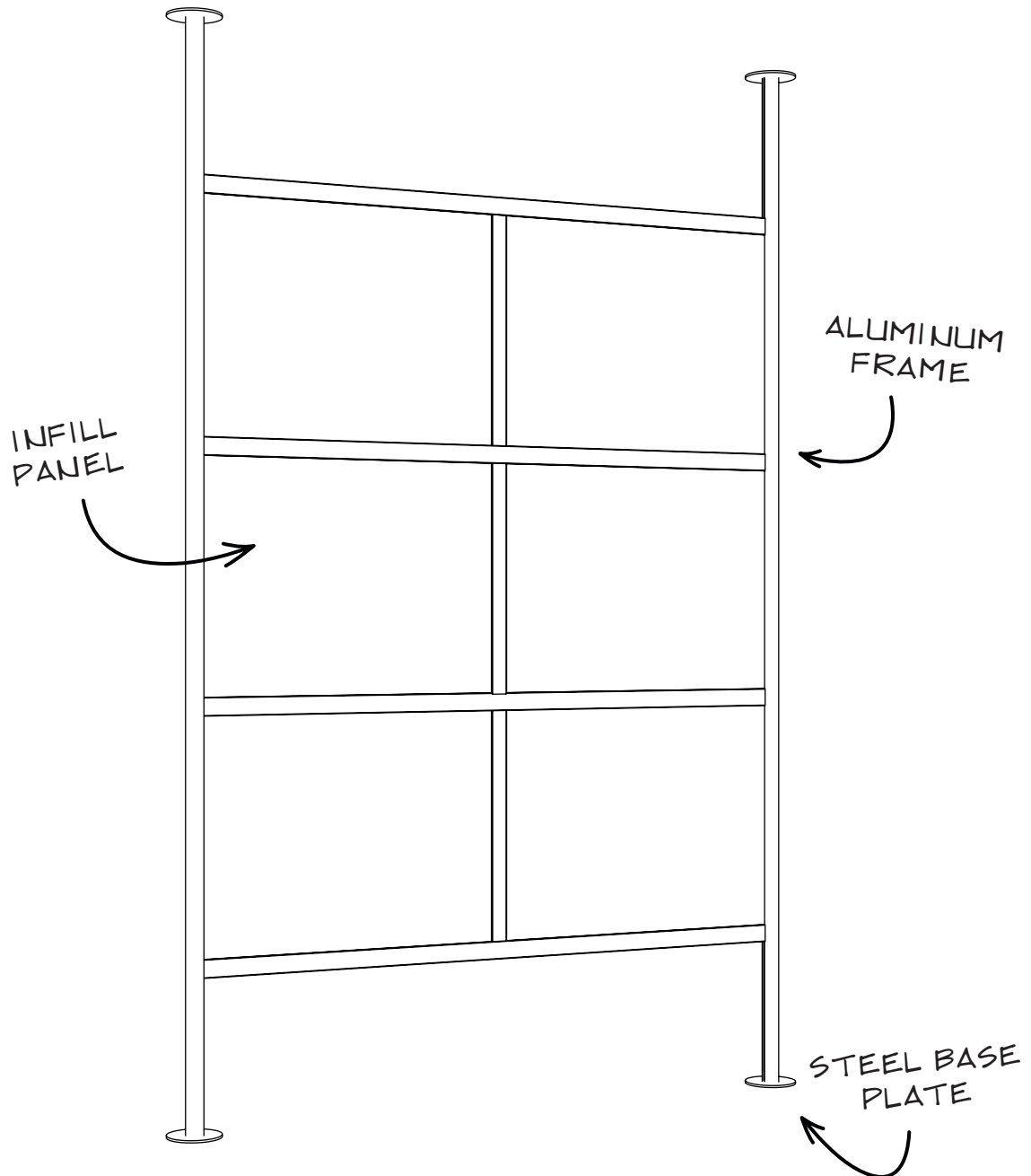

*AVAILABLE IN TWO HEIGHTS, THREE WIDTHS
& A VARIETY OF DESIGN STYLES

Aluminum Frame Finishes



Anodized Aluminum

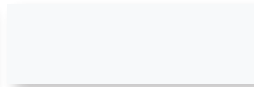

Glossy White



Matte Black

Steel Base Plate Finishes



Anodized Aluminum

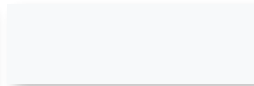

Glossy White



Matte Black

Infill Panel Finishes

LAMINATE



Maroon



Teal



Navy



Slate Blue



Gray

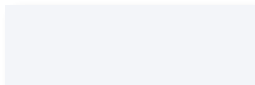

White



Black



Walnut



Oak



Elm

BLOX



Tomato Red



Electric Green



Emerald Green



Spruce Blue



True Blue

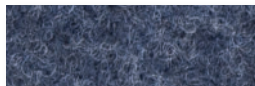

Navy

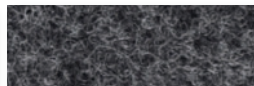

Charcoal



Medium Gray

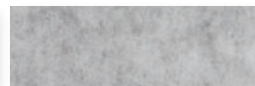

Light Gray



Almost White

*Blox is made of premium polyester fibers** Only available in 2' x 2' and 2' x 4' panels

ACOUSTIC PET



Brick



Pumpkin Spice



Cherry



Carrot



Sunflower



Straw



Lime



Guac



Ice

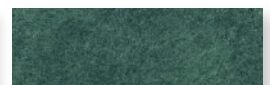

Seafoam

Infill Panel Finishes (continued)

ACOUSTIC PET

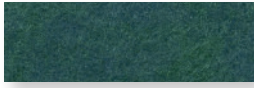

Peacock



Sapphire

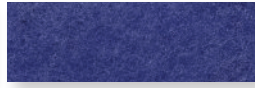

Cobalt



Midnight

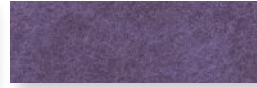

Grape



Bark



Concrete



Sand

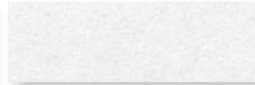

Snow



Mystic



Marble



Steel



Charcoal



Raven

WRITABLE

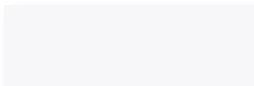

Non-magnetic Dry Erase

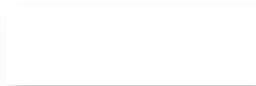

Magnetic Dry Erase

TRANSLUCENT

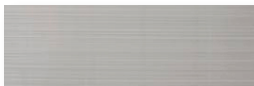

Twinwall Clear

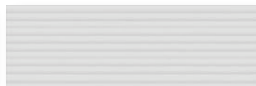

Twinwall White

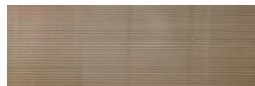

Twinwall Smoke



Frosted Acrylic

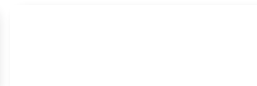

Clear Acrylic



Smoked Acrylic

SPECIALTY PANEL FINISHES



Pegboard



COM Textile



Custom Logo

Pivot architectural

a lot of privacy for a little footprint.

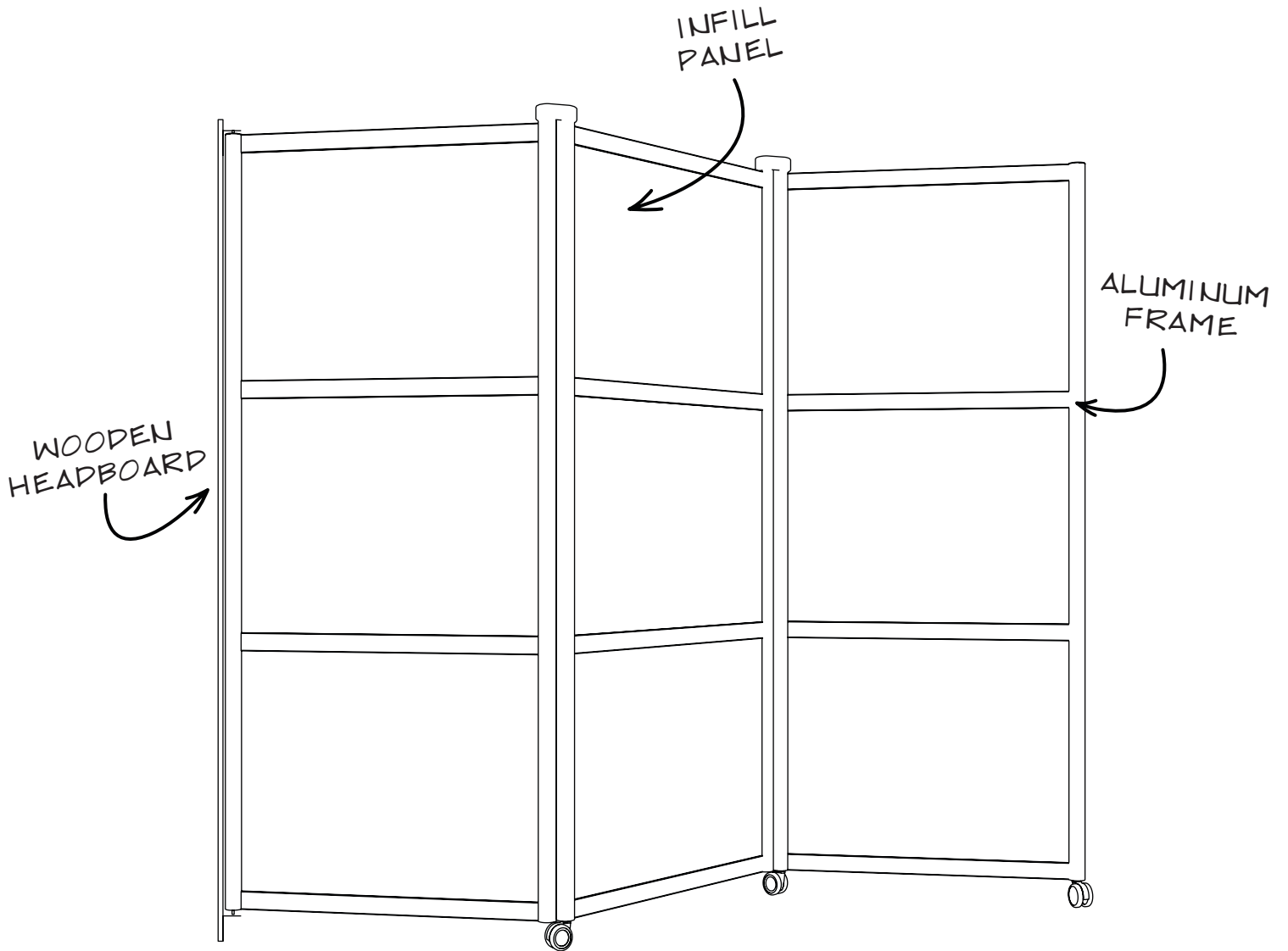

*AVAILABLE IN TWO HEIGHTS, FOUR WIDTHS

Aluminum Frame Finishes



Anodized Aluminum



Glossy White



Matte Black

Wooden Headboard Finishes



White

Infill Panel Finishes

LAMINATE



Maroon



Teal



Navy



Slate Blue



Gray

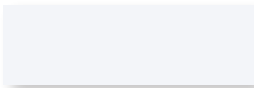

White



Black



Walnut



Oak



Elm

ACOUSTIC PET



Brick



Pumpkin Spice



Cherry



Carrot



Sunflower



Straw



Lime



Guac



Ice



Seafoam



Peacock



Sapphire



Cobalt



Midnight



Grape



Bark



Concrete



Sand

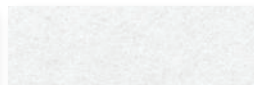

Snow



Mystic



Marble



Steel



Charcoal



Raven

Infill Panel Finishes

WRITABLE

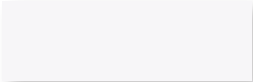

Non-magnetic Dry Erase



Magnetic Dry Erase

TRANSLUCENT



Twinwall Clear



Twinwall White



Twinwall Smoke



Frosted Acrylic



Clear Acrylic



Smoked Acrylic

SPECIALTY PANEL FINISHES



Pegboard



COM Textile



Custom Logo

Rooms architectural

make space within your space

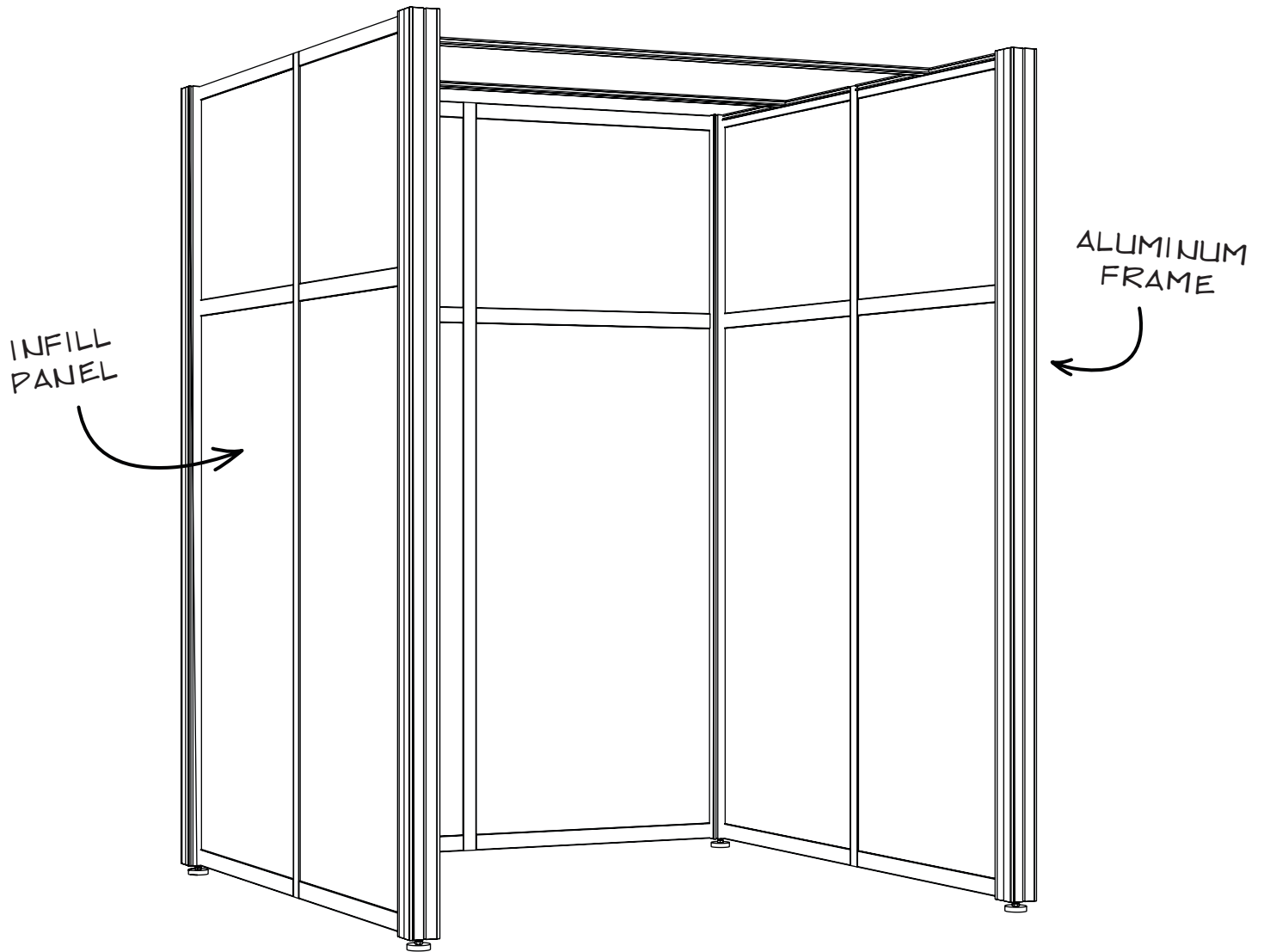

*AVAILABLE IN TWO HEIGHTS, THREE WIDTHS
& A VARIETY OF DESIGN STYLES

Aluminum Frame Finishes



Anodized Aluminum

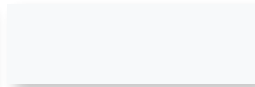

Glossy White



Matte Black

Infill Panel Finishes

LAMINATE



Maroon



Teal



Navy



Slate Blue



Gray



White



Black



Walnut



Oak



Elm

*BLOX



Tomato Red



Electric Green



Emerald Green



Spruce Blue



True Blue



Navy

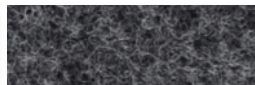

Charcoal



Medium Gray

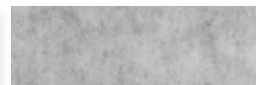

Light Gray

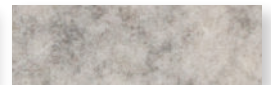

Almost White

*Blox is only available in specific Room sizes, reach out to an account manager for more clarity **Blox is made of premium polyester fibers

ACOUSTIC PET



Brick



Pumpkin Spice



Cherry



Carrot



Sunflower



Straw



Lime



Guac



Ice



Seafoam



Peacock



Sapphire



Cobalt



Midnight



Grape



Bark



Concrete



Sand

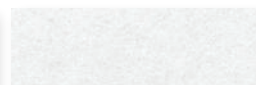

Snow



Mystic

Infill Panel Finishes

ACOUSTIC PET (CONTINUED)



Marble

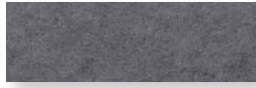

Steel



Charcoal

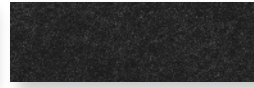

Raven

WRITABLE

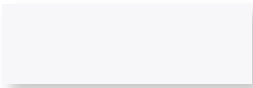

Non-magnetic Dry Erase

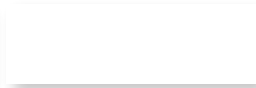

*Magnetic Dry Erase

*Magnetic Dry Erase panels are not available in Style 1 size panels

TRANSLUCENT



Twinwall Clear

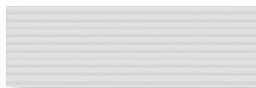

Twinwall White

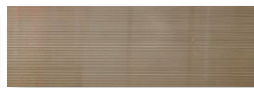

Twinwall Smoke



Frosted Acrylic

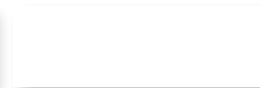

Clear Acrylic



Smoked Acrylic

SPECIALTY PANEL FINISHES



COM Textile



Custom Logo

Gravity acoustic baffle

acoustic division from above

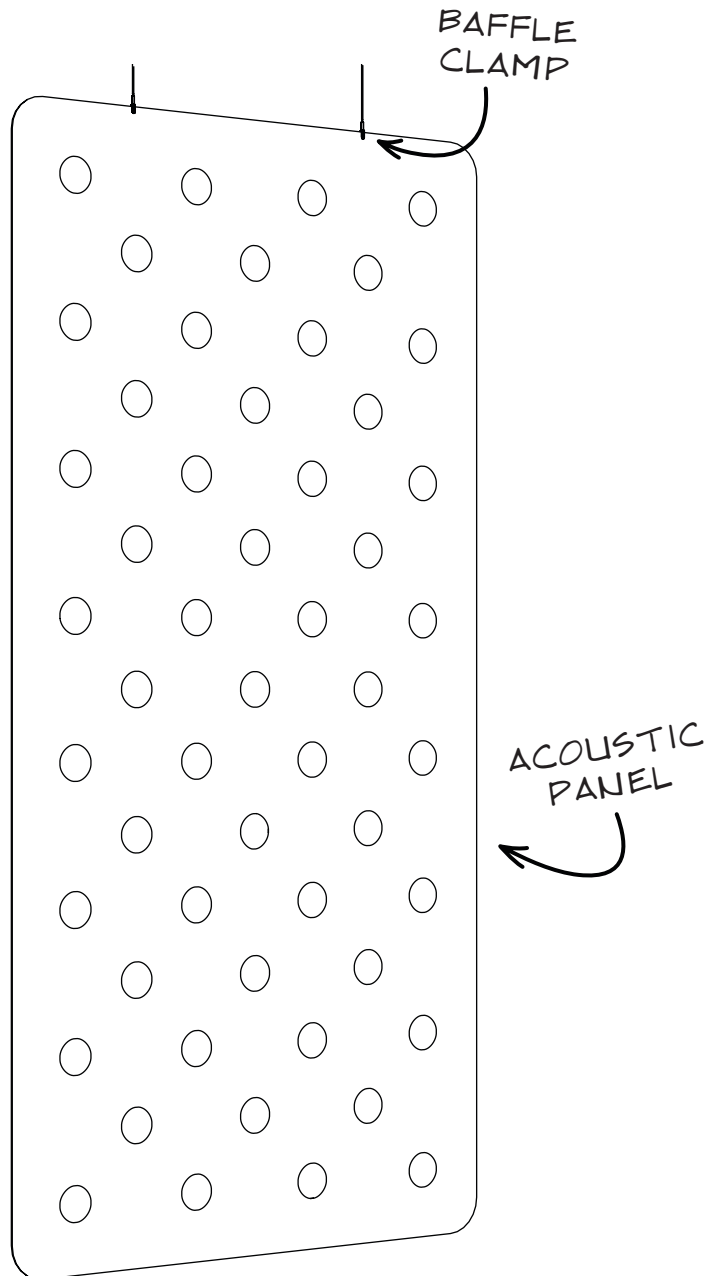

*AVAILABLE IN TWO HEIGHTS, A VARIETY OF DESIGN STYLES AND FIVE MOUNTING METHODS

Baffle Clamp Finishes

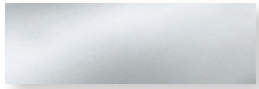

Silver

Acoustic Panel Finishes

ACOUSTIC PET

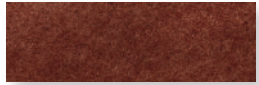

Brick



Pumpkin Spice



Cherry



Carrot



Sunflower



Straw



Lime



Guac



Ice

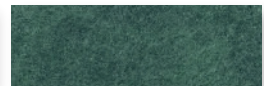

Seafoam



Peacock



Sapphire



Cobalt



Midnight



Grape



Bark



Concrete



Sand



Snow



Mystic



Marble



Steel



Charcoal



Raven

Mounting Hardware Finishes



Silver



White



Black

Gravity Panel Cut Designs



Slab

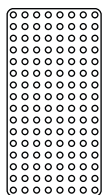

Perf



Halfsies



Slice

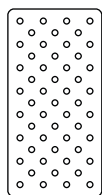

Offset

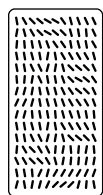

Scatter



Turn

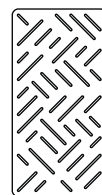

Hatch

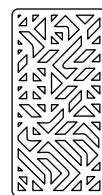

Transit

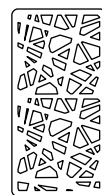

Web

Gravity Panel Cut Designs

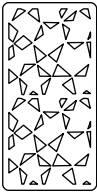

Fractal

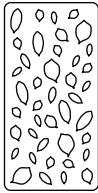

Petal

Layer acoustic baffle

an array of acoustic ceiling panels

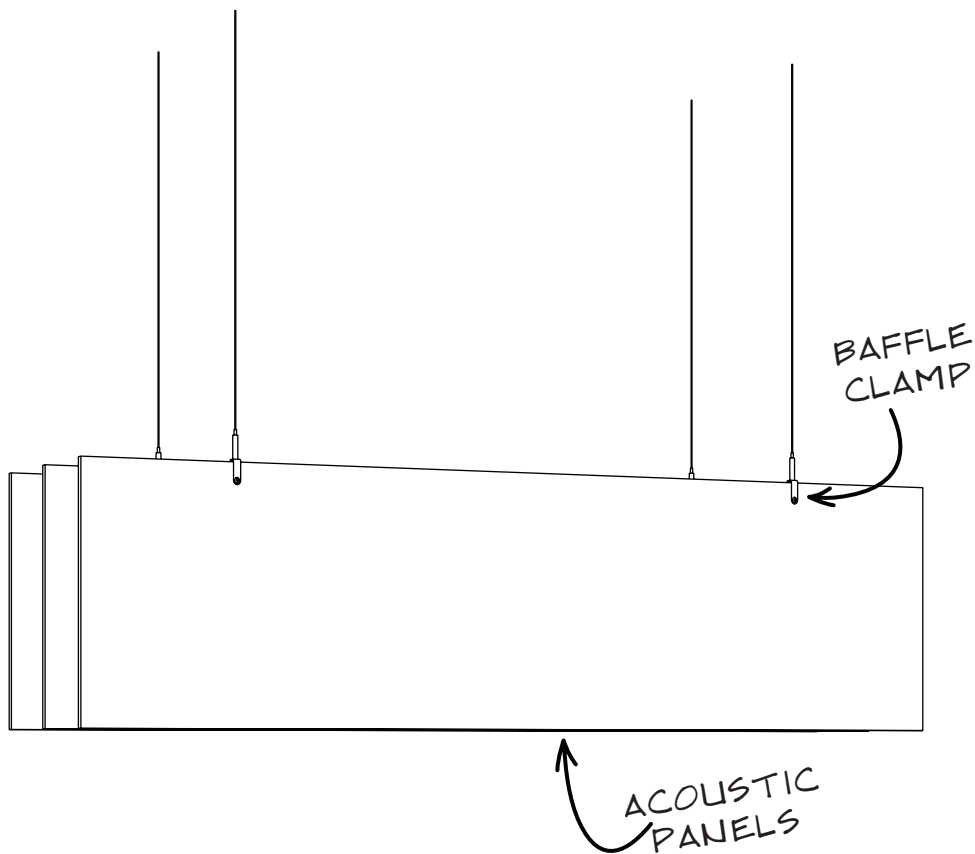

*AVAILABLE IN THREE LENGTHS AND FOUR MOUNTING METHODS

Baffle Clamp Finishes

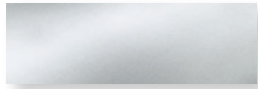

Silver

Acoustic Panel Finishes

ACOUSTIC PET



Brick



Pumpkin Spice



Cherry



Carrot



Sunflower



Straw

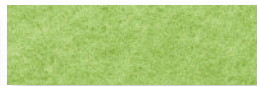

Lime



Guac



Ice

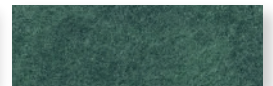

Seafoam



Peacock



Sapphire



Cobalt



Midnight



Grape



Bark



Concrete



Sand

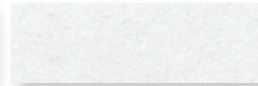

Snow



Mystic



Marble



Steel



Charcoal



Raven

Mounting Hardware Finishes



Silver



White



Black

Layer Panel Designs



Base



Pitch



Wave

Pocket acoustic baffle

playful baffles designed to catch all of your unwanted sounds

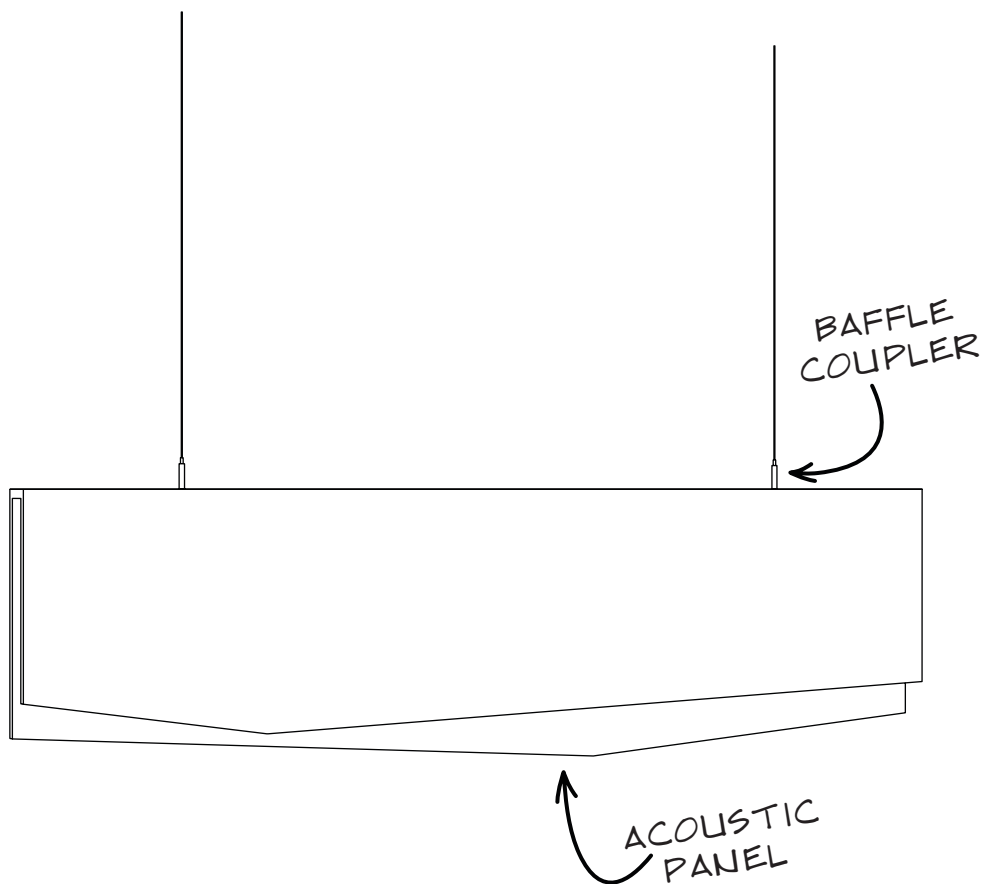

*AVAILABLE IN THREE LENGTHS AND FOUR MOUNTING METHODS

Baffle Coupler Finishes

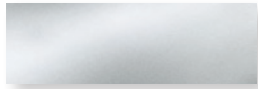

Silver

Acoustic Panel Finishes

ACOUSTIC PET



Brick



Pumpkin Spice



Cherry



Carrot



Sunflower



Straw



Lime



Guac



Ice

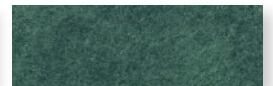

Seafoam



Peacock



Sapphire



Cobalt



Midnight



Grape



Bark



Concrete



Sand

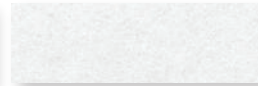

Snow



Mystic



Marble



Steel



Charcoal



Raven

Mounting Hardware Finishes



Silver



White



Black

Pocket Panel Designs

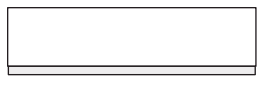

Base

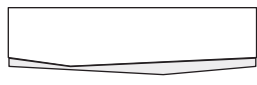

Pitch



Wave

Sky acoustic baffle

elevate your space, acoustically

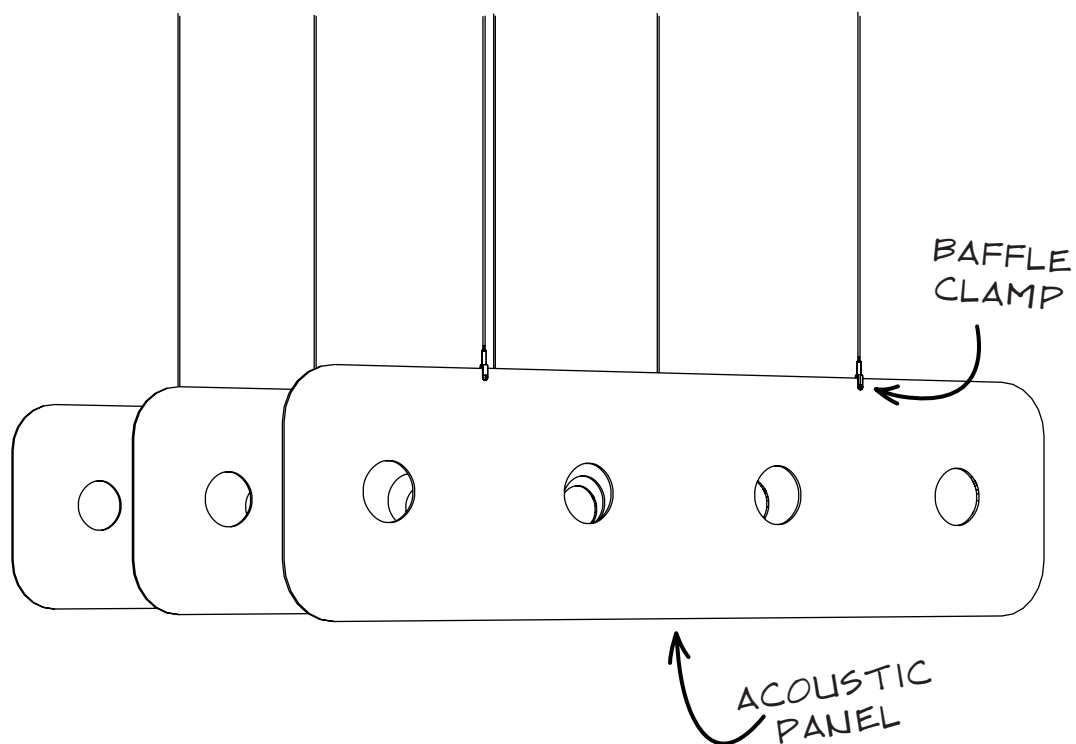

*AVAILABLE IN TWO THICKNESSES AND FOUR MOUNTING METHODS

Baffle Clamp Finishes

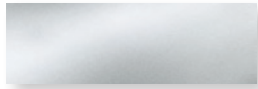

Silver

Acoustic Panel Finishes

ACOUSTIC PET



Brick



Pumpkin Spice



Cherry



Carrot



Sunflower



Straw



Lime



Guac



Ice

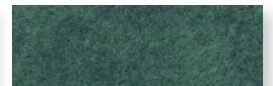

Seafoam



Peacock



Sapphire



Cobalt



Midnight



Grape



Bark



Concrete



Sand

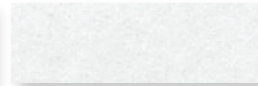

Snow



Mystic



Marble



Steel



Charcoal



Raven

Mounting Hardware Finishes



Silver



White



Black

Gravity Panel Cut Designs



Slab

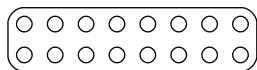

Perf

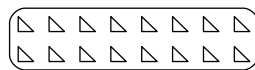

Halvesies

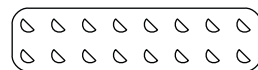

Slice

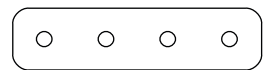

Offset

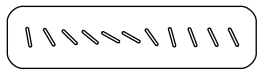

Scatter

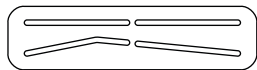

Turn

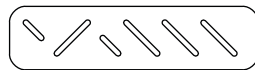

Hatch

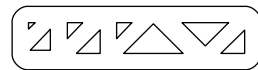

Transit



Web

Sky Panel Cut Designs



Fractal

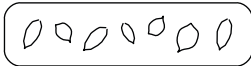

Petal

Tempo acoustic baffle

turn down the volume, with style

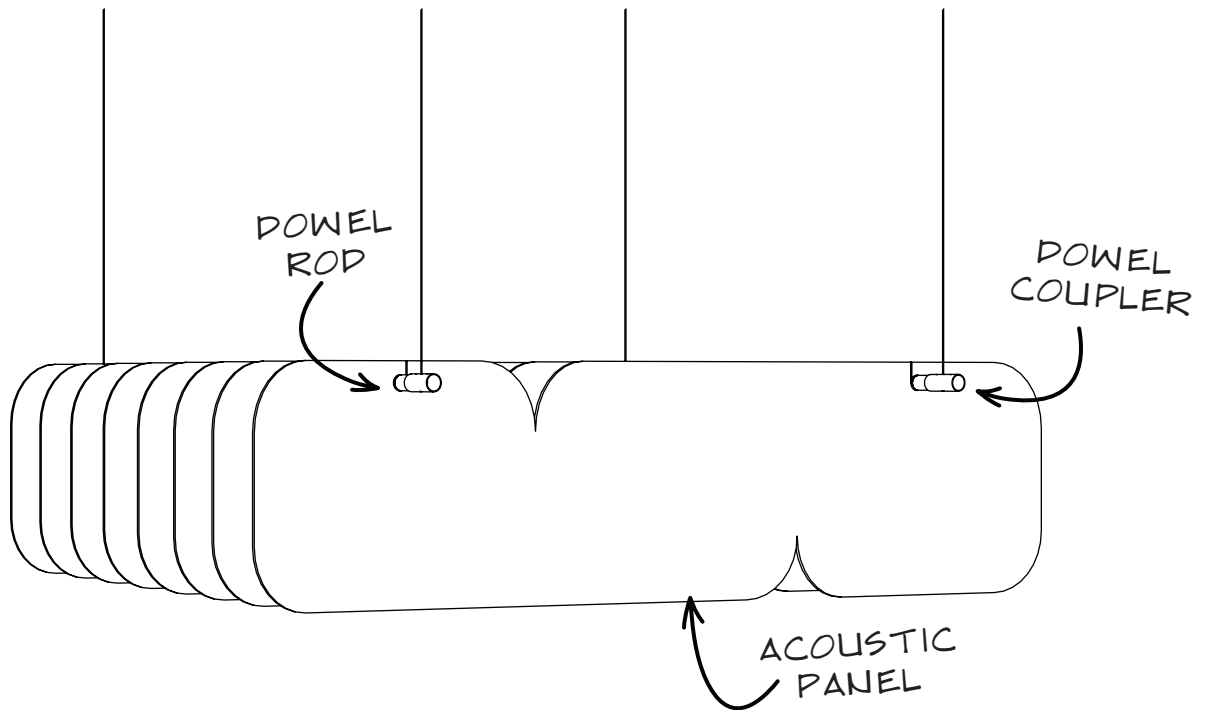

*AVAILABLE 4' X 4' GRIDS

Dowel Rod Finishes



White Ash



Aspen



Ebony

Dowel Coupler Finishes

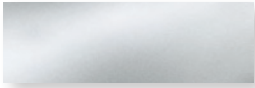

Silver



White



Black

Acoustic Panel Finishes

ACOUSTIC PET

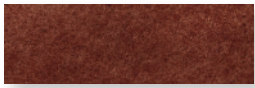

Brick



Pumpkin Spice



Cherry



Carrot



Sunflower



Straw



Lime



Guac



Ice

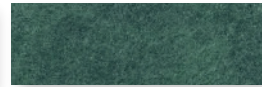

Seafoam

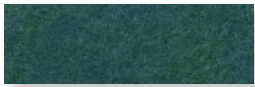

Peacock



Sapphire



Cobalt



Midnight



Grape



Bark



Concrete



Sand

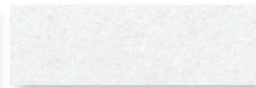

Snow



Mystic



Marble



Steel



Charcoal



Raven

Tempo Panel Designs



Turn 1



Turn 2



Turn 3



Tilt 1



Tilt 2

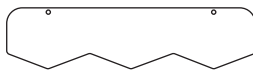

Tilt 3

Tempo Panel Designs



Tab 1



Tab 2



Tab 3



Tide 1



Tide 2



Tide 3

Thicc acoustic baffle

ceiling baffles that aren't on a diet

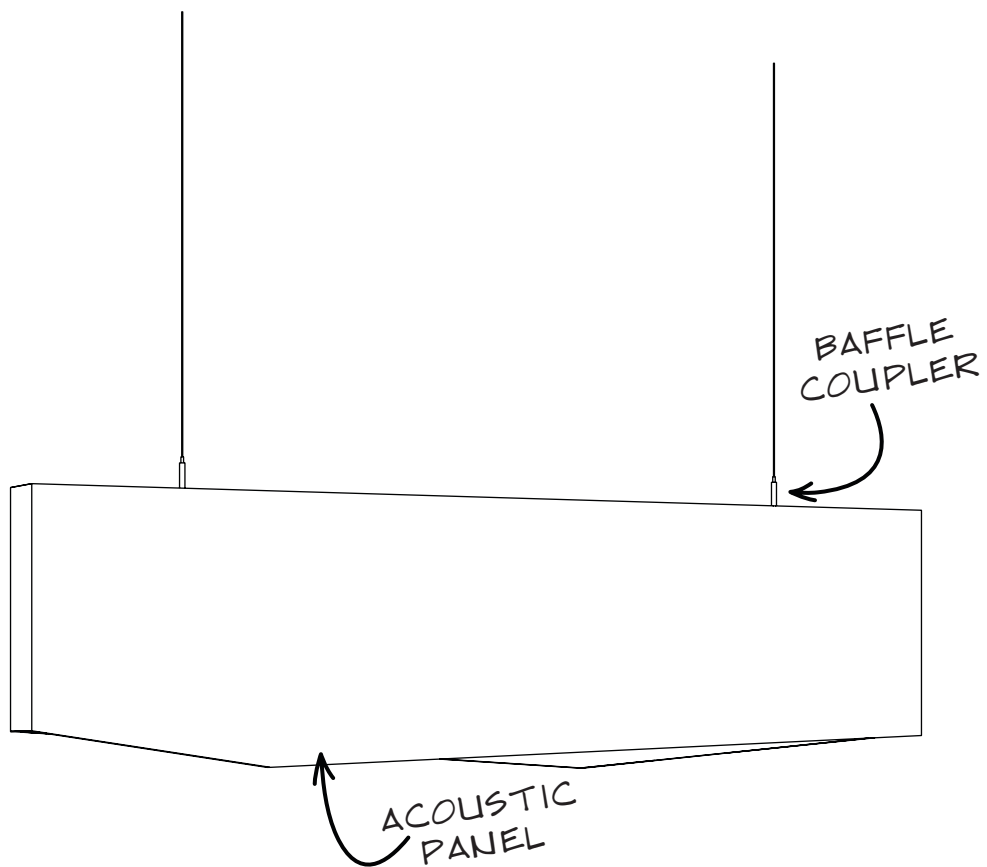

*AVAILABLE IN THREE LENGTHS AND FOUR MOUNTING METHODS

Baffle Coupler Finishes

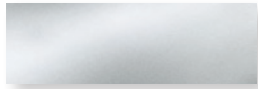

Silver

Acoustic Panel Finishes

ACOUSTIC PET



Brick



Pumpkin Spice



Cherry



Carrot



Sunflower



Straw



Lime



Guac



Ice

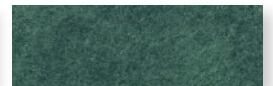

Seafoam



Peacock



Sapphire



Cobalt



Midnight



Grape



Bark



Concrete



Sand

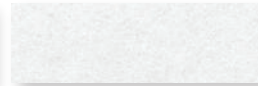

Snow



Mystic



Marble



Steel



Charcoal



Raven

Mounting Hardware Finishes



Silver



White



Black

Thicc Panel Designs



Base



Pitch



Wave

Thin acoustic baffle

noise vanishes into thin air

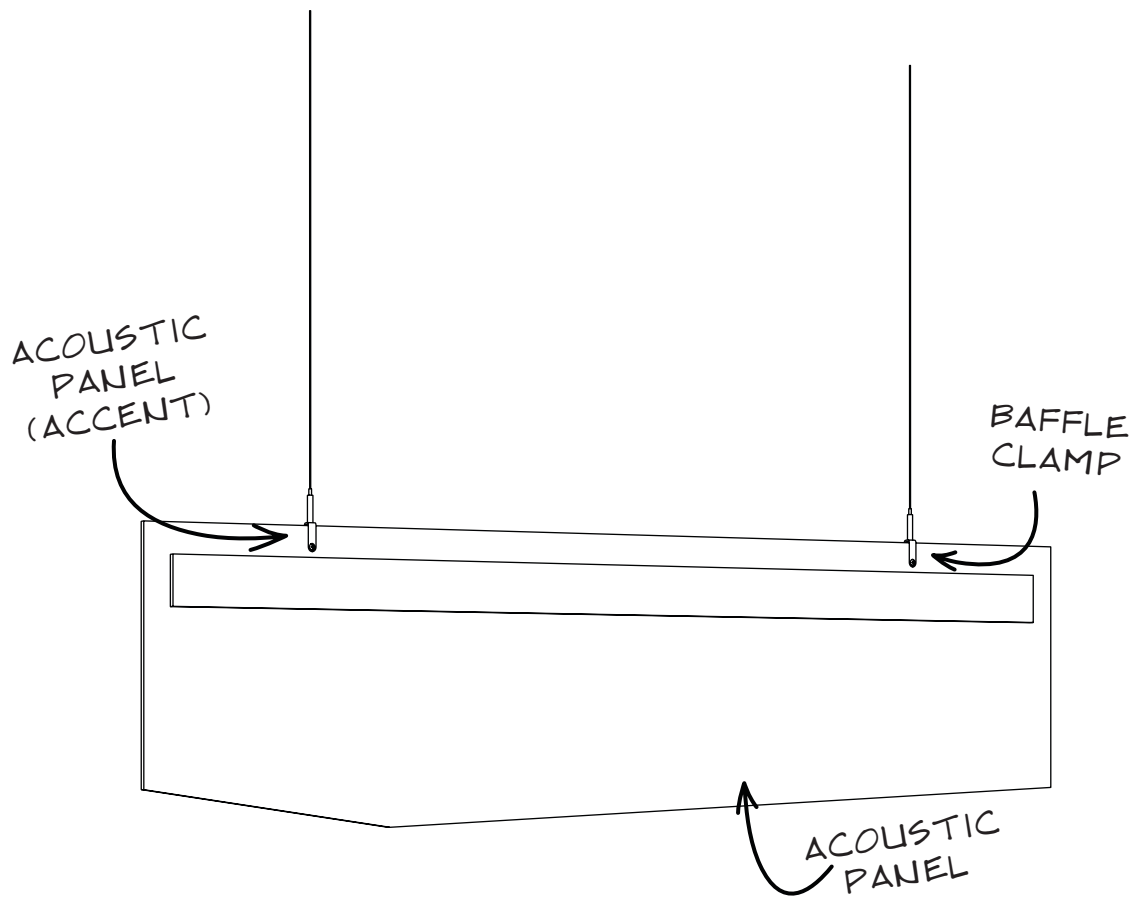

*AVAILABLE IN THREE LENGTHS AND FOUR MOUNTING METHODS

Baffle Clamp Finishes

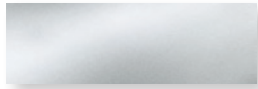

Silver

Acoustic Panel Finishes

ACOUSTIC PET



Brick



Pumpkin Spice



Cherry



Carrot



Sunflower



Straw



Lime



Guac



Ice

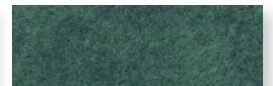

Seafoam



Peacock



Sapphire



Cobalt



Midnight



Grape



Bark



Concrete



Sand

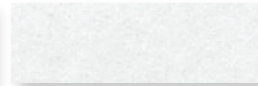

Snow



Mystic



Marble



Steel



Charcoal



Raven

Mounting Hardware Finishes



Silver



White



Black

Thin Panel Designs



Base

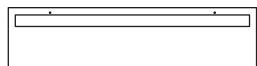

Pitch

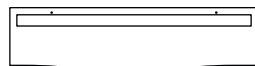

Wave

LOFTWALL