

LOFTWALL

2026 LIST PRICE GUIDE

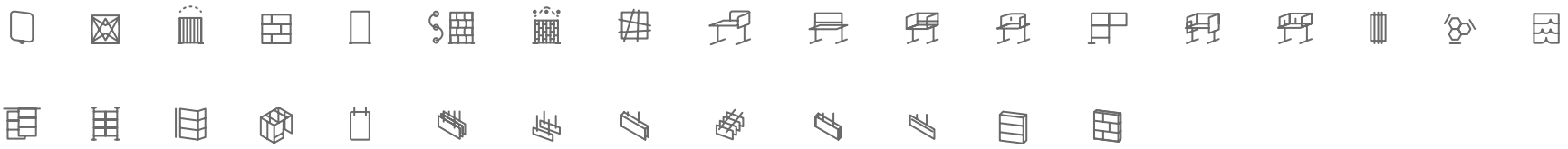



Contents

Welcome to the Loftwall price guide. Please note all displayed prices are list prices. For an industry discount, please reach out to our sales team at quotes@loftwall.com.

*All prices in USD. To convert to CAD for Canadian orders, multiply the item / total by 1.4 (subject to change at any time)

ROOM DIVIDERS

Buffer	5
Chisel	7
Flox	11
FrameWall	13
Split	19
Wave	23
Weave	25
Web	27

DESK DIVIDERS

Arc	31
Counter Shield	33
Desk Shield	37
Hide	39
Hitch	41
Parallel	45
Shelter	47

ACOUSTIC WALLCOVERINGS

Arbor	51
Tango	55
Tempo	61

ARCHITECTURAL

Glide	67
Hover	71
Pivot	73
Rooms	75

ACOUSTIC BAFFLES

Gravity	83
Layer	87
Sky	89
Pocket	91
Tempo	93
Thicc	97
Thin	99

STORAGE SYSTEMS

Hedge	103
Shift	105

THE CURVE THAT
CREATES CALM



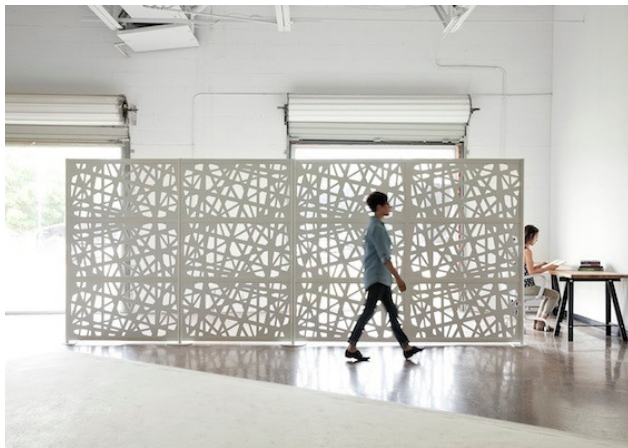
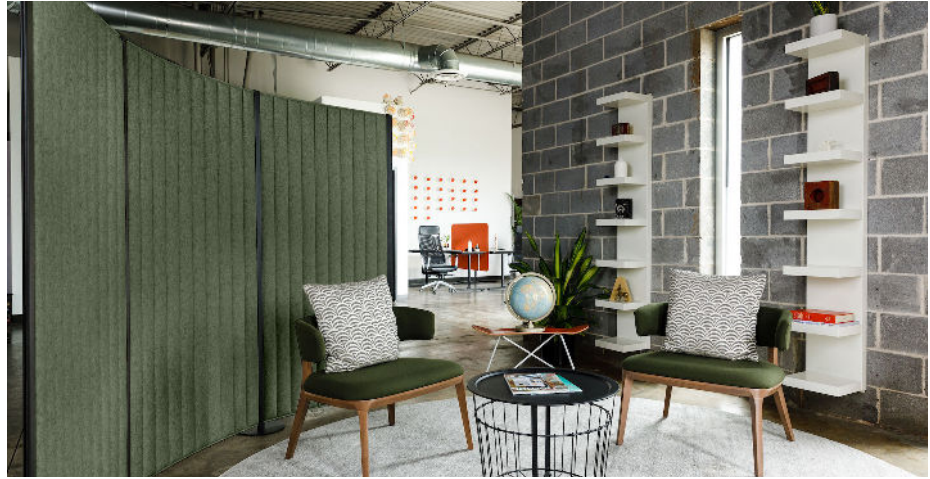

Room Dividers

Commercial-grade wall partitions for offices, hospitals, and schools. All of our room dividers are made in the USA and ship quickly.

ROOM DIVIDERS

Buffer	5
Chisel.....	7
Flox.....	11
FrameWall.....	13
Split.....	19
Wave.....	23
Weave.....	25
Web.....	27



SCAN FOR MORE VISUAL
REFERENCES OF FEATURED
PRODUCTS





Buffer room divider

Pricing

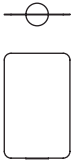

Buffer pricing is determined by a size-based SKU and quantity. While pricing varies based on quantity, all panel and base finishes are priced the same.

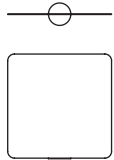
Typicals

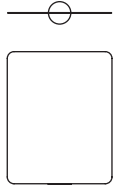
Buffer is available in 9 unique sizes. Buffer is available with a 2', 3', or 4' width and a 4', 5', or 6' height. Buffer is available in 24 9mm acoustic finishes noted as -XXX- in the product SKU.

	2' WIDE		3' WIDE		4' WIDE	
4' TALL						
	BF-4-2-XXX		BF-4-3-XXX		BF-4-4-XXX	
	Dimensions	2' W x 4' H	Dimensions	3' W x 4' H	Dimensions	4' W x 4' H
	Quantity of 1	\$1,060.00	Quantity of 1	\$1,165.00	Quantity of 1	\$1,250.00
5' TALL						
	BF-5-2-XXX		BF-5-3-XXX		BF-5-4-XXX	
	Dimensions	2' W x 5' H	Dimensions	3' W x 5' H	Dimensions	4' W x 5' H
	Quantity of 1	\$1,145.00	Quantity of 1	\$1,265.00	Quantity of 1	\$1,360.00

Typicals Continued

6' TALL	2' WIDE	3' WIDE	4' WIDE
			
	BF-6-2-XXX	BF-6-3-XXX	BF-6-4-XXX
	<hr/> Dimensions 2' W x 6' H	<hr/> Dimensions 3' W x 6' H	<hr/> Dimensions 4' W x 6' H
	<hr/> Quantity of 1 \$1,210.00	<hr/> Quantity of 1 \$1,340.00	<hr/> Quantity of 1 \$1,460.00

Bases

All Buffers come with a 10" circular steel base. This base is available in a variety of powder coat finishes. For a complete list of finishes, please visit loftwall.com/buffer. All base finishes are included in the price.



BP-08-XX

10" Circular Base

Price	<i>Included</i>
-------	-----------------

☒ Chisel room divider

Pricing

To price a Chisel wall, select a size-based SKU and add the price of 2 base plates and the price of each needed panel. All similar sized Chisel walls are priced the same, regardless of frame or panel finish.

Frame Typicals

Chisel is available in 12 acoustic finishes noted as -XX- in the product SKU.

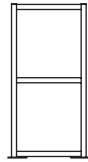

FW-XX-LH-2-3.0

Dimensions	28" W x 53" H
Panel(s)	(2) 2x2
Price	\$715.00



FW-XX-LH-3-3.0

Dimensions	40" W x 53" H
Panel(s)	(2) 2x3
Price	\$835.00

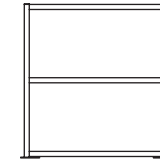

FW-XX-LH-4-3.0

Dimensions	52" W x 53" H
Panel(s)	(2) 2x4
Price	\$990.00

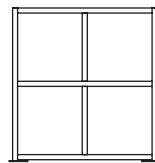

FW-XX-LH-4-3.2

Dimensions	52" W x 53" H
Panel(s)	(4) 2x2
Price	\$990.00



FW-XX-LH6-3.2-2

Dimensions	76" W x 53" H
Panel(s)	(4) 2x3
Price	\$1,430.00

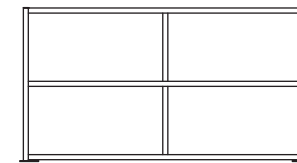

FW-XX-LH-8-3.2

Dimensions	100" W x 53" H
Panel(s)	(4) 2x4
Price	\$1,870.00

Frame Typicals

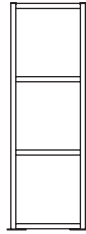

FW-XX-FH-2-4.0

Dimensions	28" W x 78" H
Panel(s)	(3) 2x2
Price	\$990.00

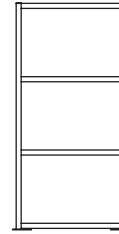

FW-XX-FH-3-4.0

Dimensions	40" W x 78" H
Panel(s)	(3) 2x3
Price	\$1,180.00

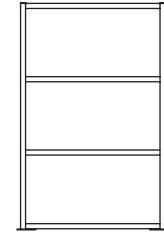

FW-XX-FH-4-4.0

Dimensions	52" W x 78" H
Panel(s)	(3) 2x4
Price	\$1,335.00

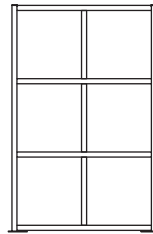

FW-XX-FH-4-4.3

Dimensions	52" W x 78" H
Panel(s)	(6) 2x2
Price	\$1,335.00

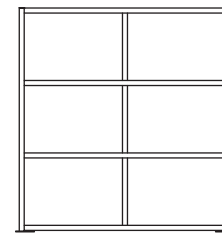

FW-XX-FH-6-4.3-2

Dimensions	76" W x 78" H
Panel(s)	(6) 2x3
Price	\$1,890.00



FW-XX-FH-8-4.3

Dimensions	100" W x 78" H
Panel(s)	(6) 2x4
Price	\$2,365.00

☒ Chisel room divider

Available Designs

Chisel panels are available in 12 standard designs. All panels are priced the same, regardless of selected design.

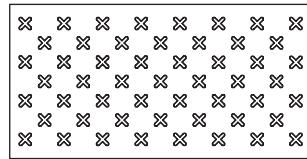

MULTIPLY

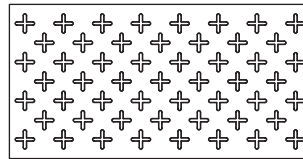

PLUS

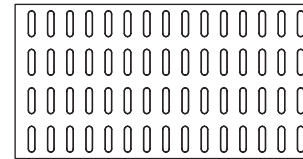

PILLS

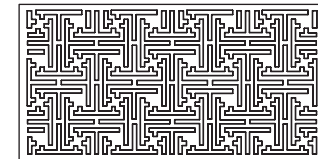

MAZE

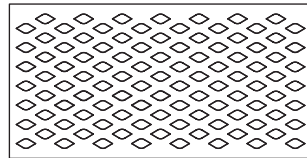

GRATE

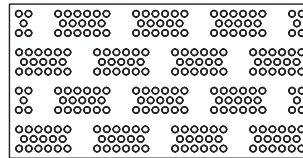

BRICK

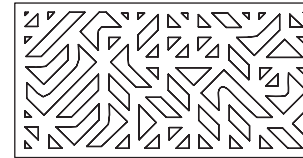

TRANSIT

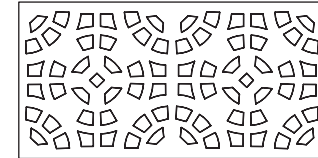

AZTEC

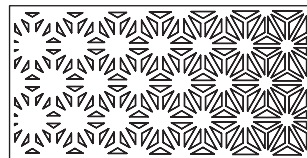

KALEIDOSCOPE

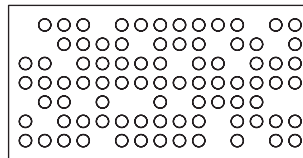

CIRCLES

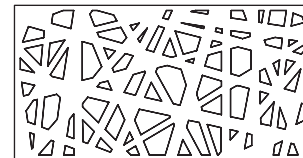

WEB

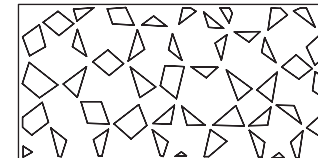

FRACTAL



Panels

Chisel panels are available in 3 different sizes, with the exception of Kaleidoscope which is only offered in 2x4. Each panel is available in a variety of finishes. For a complete list of finishes, please visit loftwall.com/chisel. All panel finishes have the same price.

Name	Description	2x2	2x3	2x4
PET felt (*PATTERN*-AKUS-*SIZE*-*COLOR*)	Sound-absorbing panel	\$135.00	\$195.00	\$265.00

Bases

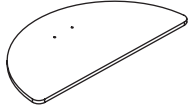
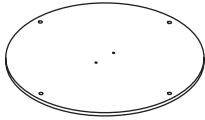
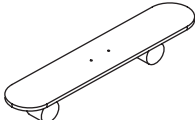
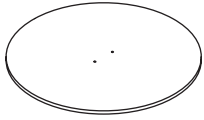
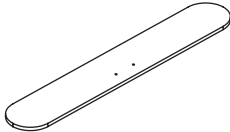
Chisel dividers are available with a variety of bases. These are available in 3 finishes: Black (BK), White (WH), and Silver (SV) noted in place of -XX- in the product SKU. All base finishes are included in the price. Bases are not included in the listed price under the typical section. Take note, -XX signifies acoustic color choice.

			
BP-01-XX 13" Half Moon	BP-02-XX 12" Floor Mount	BP-03-XX 15" Caster	BP-04-XX 12" Link
Price \$140.00 per	Price \$140.00 per	Price \$140.00 per	Price \$140.00 per
			
BP-05-XX 12" Flush	BP-06-XX/BP-07-XX 6" Floor/Non-Floor Mount		
Price \$140.00 per	Price \$140.00 per		

Frame Colors

Chisel is available in 3 standard frame finishes, Black (BK), White (WH), and Silver (SV) noted in place of -XX- in the product SKU. All standard frame finishes are priced the same. Custom colors may be available upon request.

Finish	Price
Silver, White, and Black	Price included in product.
Custom Colors and Finishes	Contact us for a quote!

Flox room divider

Pricing

The below prices include all necessary hardware and panels needed for Flox. While Flox is available with 3 panel finishes and 3 frame finishes, all finishes are priced the same.

Typicals

Flox dividers can be chained together to create longer runs. Flox is available in 3 acoustic finishes noted as -XX- in the product SKU.

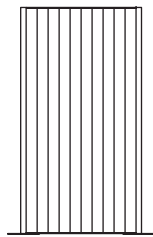

FX-XX-1

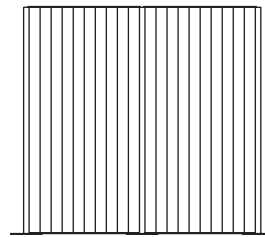

FX-XX-2

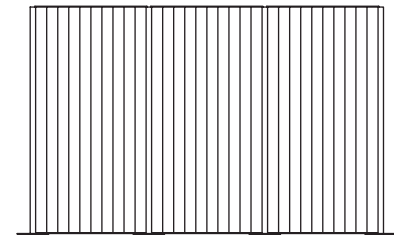

FX-XX-3

Dimensions	39" W x 73" H	Dimensions	76" W x 73" H	Dimensions	111" W x 73" H
Panel(s)	(1) Flox Panel	Panel(s)	(2) Flox Panel	Panel(s)	(3) Flox Panel
Price	\$2,405.00	Price	\$4,605.00	Price	\$6,810.00

Panels

Flox divider panels are available in 3 finishes. All panel finishes cost the same and have the same acoustic properties.

Panel	Description
Flox (FLOX-36-*color*)	Flexible wool

Bases

All Flox panels come with a 10" circular steel base. These are available in 3 finishes: Black (BK), White (WH), and Silver (SV) noted in place of -XX- in the product SKU. All base finishes are included in the price.



BP-08-XX

10" Circular Base

Price	<i>Included</i>
-------	-----------------

Frame Colors

Flox is available in 3 standard frame finishes, Black (BK), White (WH), and Silver (SV) noted in place of -XX- in the product SKU. All standard frame finishes are priced the same. Custom colors may be available upon request.

Finish	Price
Silver, White, and Black	Price included in product.
Custom Colors and Finishes	Contact us for a quote!

Framewall room divider

Pricing

To price Framewall, select a size-based SKU and add the price of 2 bases and preferred insert panels.

Typicals

Framewall dividers are available in 30 unique size and style based SKUs. Note each SKU comes with different panel insert requirements.

Framewall is available in 12 acoustic finishes noted as -XX- in the product SKU.



FW-XX-LH-2-3.0

Dimensions 28" W x 53" H

Panel(s) (2) 2x2

Price **\$715.00**



FW-XX-LH-3-3.0

Dimensions 40" W x 53" H

Panel(s) (2) 2x3

Price **\$835.00**

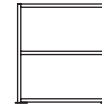

FW-XX-LH-4-3.0

Dimensions 52" W x 53" H

Panel(s) (2) 2x4

Price **\$990.00**

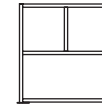

FW-XX-LH-4-3.1

Dimensions 52" W x 53" H

Panel(s) (2) 2x2
(1) 2x4

Price **\$990.00**

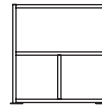

FW-XX-LH-4-3.1-2

Dimensions 52" W x 53" H

Panel(s) (2) 2x2
(1) 2x4

Price **\$990.00**

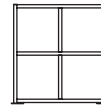

FW-XX-LH-4-3.2

Dimensions 52" W x 53" H

Panel(s) (4) 2x2

Price **\$990.00**

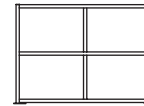

FW-XX-LH-6-3.2-2

Dimensions 76" W x 53" H

Panel(s) (4) 2x3

Price **\$1,430.00**

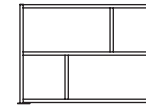

FW-XX-LH-6-3.2

Dimensions 76" W x 53" H

Panel(s) (2) 2x2
(2) 2x4

Price **\$1,430.00**

Typicals Continued

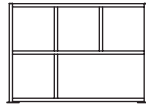

FW-XX-LH-6-3.3

Dimensions 76" W x 53" H

(4) 2x2

Panel(s) (1) 2x4

Price **\$1,430.00**

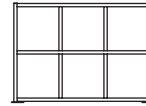

FW-XX-LH-6-3.4

Dimensions 76" W x 53" H

(6) 2x2

Panel(s)

Price **\$1,430.00**



FW-XX-LH-8-3.2

Dimensions 100" W x 53" H

(4) 2x4

Panel(s)

Price **\$1,870.00**



FW-XX-LH-8-3.3

Dimensions 100" W x 53" H

(2) 2x2

Panel(s) (3) 2x4

Price **\$1,870.00**

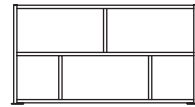

FW-XX-LH-8-3.3-2

Dimensions 100" W x 53" H

(2) 2x2

Panel(s) (3) 2x4

Price **\$1,870.00**

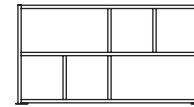

FW-XX-LH-8-3.4

Dimensions 100" W x 53" H

(4) 2x2

Panel(s) (2) 2x4

Price **\$1,870.00**

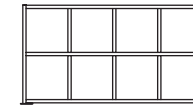

FW-XX-LH-8-3.6

Dimensions 100" W x 53" H

(8) 2x2

Panel(s)

Price **\$1,870.00**



FW-XX-FH-2-4.0

Dimensions 28" W x 78" H

(3) 2x2

Panel(s)

Price **\$990.00**



FW-XX-FH-3-4.0

Dimensions 40" W x 78" H

(3) 2x3

Panel(s)

Price **\$1,180.00**

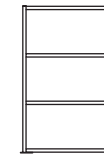

FW-XX-FH-4-4.0

Dimensions 52" W x 78" H

(3) 2x4

Panel(s)

Price **\$1,335.00**

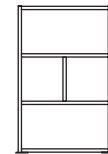

FW-XX-FH-4-4.1

Dimensions 52" W x 78" H

(2) 2x2

Panel(s) (2) 2x4

Price **\$1,335.00**

Framewall room divider

Typicals
Continued

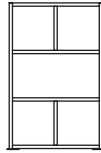

FW-XX-FH-4-4.2

Dimensions 52" W x 78" H

(4) 2x2

Panel(s) (1) 2x4

Price **\$1,335.00**

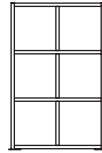

FW-XX-FH-4-4.3

Dimensions 52" W x 78" H

(6) 2x2

Panel(s) (6) 2x2

Price **\$1,335.00**

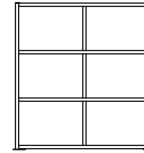

FW-XX-FH-6-4.3-2

Dimensions 76" W x 78" H

(6) 2x3

Panel(s) (6) 2x3

Price **\$1,890.00**

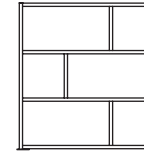

FW-XX-FH-6-4.3

Dimensions 76" W x 78" H

(3) 2x2

Panel(s) (3) 2x4

Price **\$1,890.00**

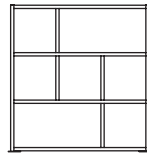

FW-XX-FH-6-4.4

Dimensions 76" W x 78" H

(5) 2x2

Panel(s) (2) 2x4

Price **\$1,890.00**

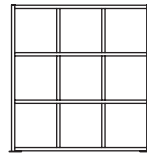

FW-XX-FH-6-4.6

Dimensions 76" W x 78" H

(9) 2x2

Panel(s) (9) 2x2

Price **\$1,890.00**

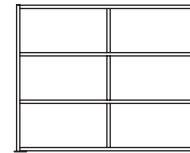

FW-XX-FH-8-4.3

Dimensions 100" W x 78" H

(6) 2x4

Panel(s) (6) 2x4

Price **\$2,365.00**

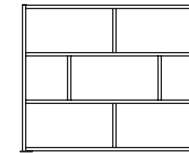

FW-XX-FH-8-4.4

Dimensions 100" W x 78" H

(2) 2x2

Panel(s) (5) 2x4

Price **\$2,365.00**

Typicals Continued

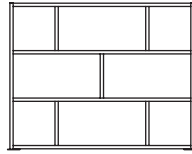

FW-XX-FH-8-4.5

Dimensions 100" W x 78" H

(4) 2x2

Panel(s) (4) 2x4

Price **\$2,365.00**

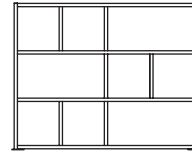

FW-XX-FH-8-4.6

Dimensions 100" W x 78" H

(6) 2x2

Panel(s) (3) 2x4

Price **\$2,365.00**

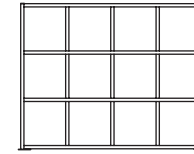

FW-XX-FH-8-4.9

Dimensions 100" W x 78" H

(12) 2x2

Panel(s) (12) 2x2

Price **\$2,365.00**

Panels

Frame wall panels are available in a variety of finishes. Note: panel SKUs are identified *finish*-*size*-*color*. For a complete list of finishes, please visit loftwall.com/frame wall.

Level	Name	Description	2x2	2x3	2x4
1	PET felt (AKUS-)	Sound-absorbing panel	\$85.00	\$125.00	\$170.00
1	Twinwall Polycarbonate (TW-)	Translucent panel	\$85.00	\$125.00	\$170.00
2	Frosted or Clear Acrylic (AC-)	Translucent panel	\$145.00	\$210.00	\$280.00
2	Nonmagnetic Dry Erase (DEP-)	White dry erase surface	\$145.00	\$210.00	\$280.00
2	Cutout Composite Panel (PEG-) (WEB-)	Pegboard & Web	\$145.00	\$210.00	\$280.00
2	Laminates (SC-)	Woodgrain and solid finishes	\$145.00	\$210.00	\$280.00
2	Chisel (*PATTERN*-AKUS-)	Acoustic knife cut design panels	\$145.00	\$210.00	\$280.00
3	Magnetic Dry Erase (DEM-)	White dry erase surface	\$415.00	\$620.00	\$820.00
3	Blox Panel (BLX-)	Up to 85% sound absorption	\$480.00	N/A	\$945.00
3	Custom Artwork Panel	Custom branded panels	quote	quote	quote
3	Custom Material Panel	3Form, Lumicor, Wilsonart	quote	quote	quote

Framewall room divider

Frame Colors

Framewall is available in 3 standard frame finishes, Black (BK), White (WH), and Silver (SV) noted in place of -XX- in the product SKU. All standard frame finishes are priced the same. Custom colors may be available upon request.

Name	Description
Silver, White, and Black	Price included in product.
Custom Colors and Finishes	Contact us for a quote!

Bases

Framewall is available with a variety of bases. These are available in 3 finishes: Black (BK), White (WH), and Silver (SV) noted in place of -XX- in the product SKU. All base finishes are included in the price. Bases are not included in the listed price under the typical section.

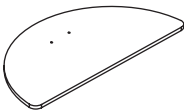
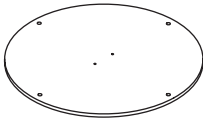
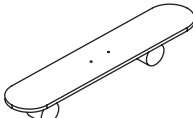
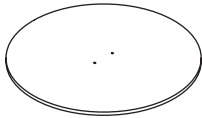
			
BP-01-XX 13" Half Moon	BP-02-XX 12" Floor Mount	BP-03-XX 15" Caster	BP-04-XX 12" Link
Price \$140.00 per	Price \$140.00 per	Price \$140.00 per	Price \$140.00 per

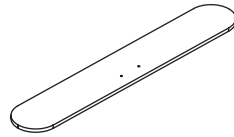

BP-05-XX

12" Flush



BP-06-XX/BP-07-XX

6" Floor/Non-Floor Mount

Price	\$140.00 per	Price	\$140.00 per
-------	---------------------	-------	---------------------

□ Split room divider

Pricing

To price Split, select a size-based SKU and add the price of 2 base plates and the price of each panel needed.

Typicals

Split is available in 8 unique size-based styles. Split is available in 3 frame finishes noted by the first set of -XX- and 12 acoustic finishes noted as the second set of -XX- in the product SKU.

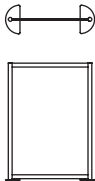
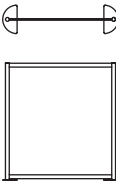
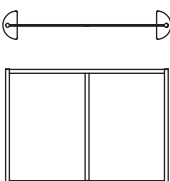
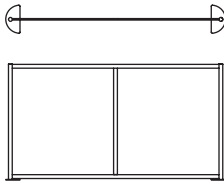
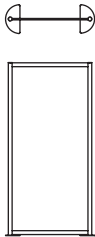
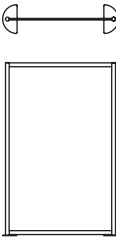
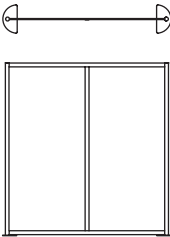
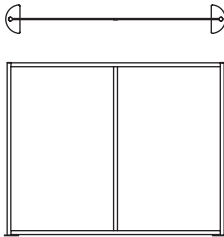
	40" WIDE	52" WIDE	76" WIDE	100" WIDE
53" TALL				
	SP-XX-LH-3	SP-XX-LH-4	SP-XX-LH-6	SP-XX-LH-8
	Panel(s) (1) 40"	Panel(s) (1) 52"	Panel(s) (2) 40"	Panel(s) (2) 52"
	Level 1 \$1,320.00	Level 1 \$1,455.00	Level 1 \$2,215.00	Level 1 \$2,335.00
	Level 2 \$1,460.00	Level 2 \$1,655.00	Level 2 \$2,495.00	Level 2 \$2,735.00
78" TALL				
	SP-XX-FH-3	SP-XX-FH-4	SP-XX-FH-6	SP-XX-FH-8
	Panel(s) (1) 40"	Panel(s) (1) 52"	Panel(s) (2) 40"	Panel(s) (2) 52"
	Level 1 \$1,670.00	Level 1 \$1,740.00	Level 1 \$2,870.00	Level 1 \$2,965.00
	Level 2 \$1,900.00	Level 2 \$2,060.00	Level 2 \$3,330.00	Level 2 \$3,605.00

Panels

Split panels are available in a variety of finishes.

Level	Name	Description
1	PET felt (AKUS-)	Sound-absorbing panel
1	Twinwall Polycarbonate (TW-)	Translucent panel
2	Frosted or Clear Acrylic (AC-)	Translucent panel
2	Nonmagnetic Dry Erase (DEP-)	White dry erase surface
2	Laminates (SC-)	Woodgrain and solid finishes

Frame Colors

Split is available in 3 standard frame finishes, Black (BK), White (WH), and Silver (SV) noted in place of -XX- in the product SKU. All standard frame finishes are priced the same. Custom colors may be available upon request.

Name	Description
Silver, White, and Black	Price included in product.
Custom Colors and Finishes	Contact us for a quote!

Bases

Split is available with a variety of bases. These are available in 3 finishes: Black (BK), White (WH), and Silver (SV) noted in place of -XX- in the product SKU. All base finishes are included in the price. Bases are not included in the listed price under the typical section.

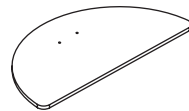

BP-01-XX
13" Half Moon

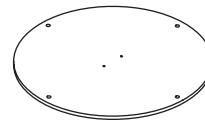

BP-02-XX
12" Floor Mount

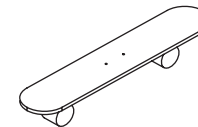

BP-03-XX
15" Caster

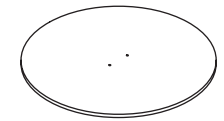

BP-04-XX
12" Link

Price	\$140.00 per	Price	\$140.00 per	Price	\$140.00 per	Price	\$140.00 per
-------	---------------------	-------	---------------------	-------	---------------------	-------	---------------------

□ Split room divider

Bases
Continued

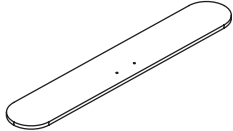

BP-05-XX
12" Flush



BP-06-XX/BP-07-XX
6" Floor/Non-Floor Mount

Price	\$140.00 per	Price	\$140.00 per
-------	---------------------	-------	---------------------



\$ **Wave** room divider

Pricing

To price Wave, select a size-based SKU and add the price of 2 base plates. Frame color and panel inserts do no impact the price of the Wave.

Typicals

Wave is available in 3 unique size-based styles. Wave is available in 3 finishes noted as -XX- in the product SKU.

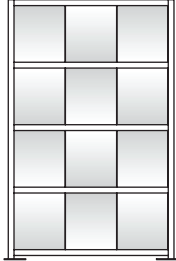
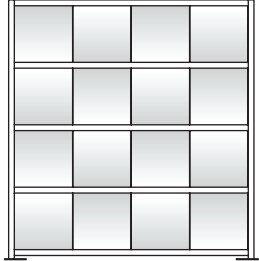
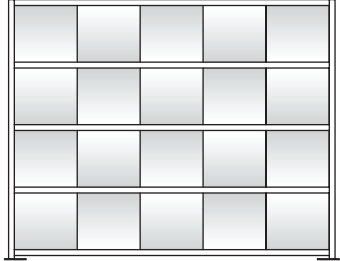
	52" WIDE	76" WIDE	100" WIDE
			
			
78" TALL			
	WA-XX-FH-4	WA-XX-FH-6	WA-XX-FH-8
Dimensions	53" W x 78" H	Dimensions 76" W x 78" H	Dimensions 100" W x 78" H
Panels	(12) WW-SM-XX	Panels (16) WW-MD-XX	Panels (20) WW-LG-XX
Price	\$1,855.00	Price \$2,665.00	Price \$3,395.00

Panels

Wave divider panels are in 3 standard finishes. All panel finishes are priced the same.

Panel	Description	Colors
Wave (WW-)	Undulating Panel	White, Black, Gray

Frame Colors

Split is available in 3 standard frame finishes, Black (BK), White (WH), and Silver (SV) noted in place of -XX- in the product SKU. All standard frame finishes are priced the same. Custom colors may be available upon request.

Finish	Price
Silver, White, and Black	Price included in product.
Custom Colors and Finishes	Contact us for a quote!

Bases

Wave is available with a variety of bases. These are available in 3 finishes: Black (BK), White (WH), and Silver (SV) noted in place of -XX- in the product SKU. All base finishes are included in the price. Bases are not included in the listed price under the typical section.

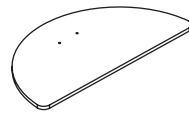

BP-01-XX
13" Half Moon

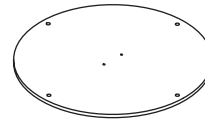

BP-02-XX
12" Floor Mount

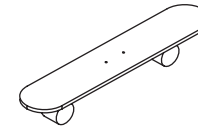

BP-03-XX
15" Caster



BP-04-XX
12" Link

Price	\$140.00 per	Price	\$140.00 per	Price	\$140.00 per	Price	\$140.00 per
-------	---------------------	-------	---------------------	-------	---------------------	-------	---------------------

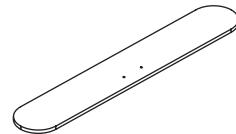

BP-05-XX
12" Flush



BP-06-XX/BP-07-XX
6" Floor/Non-Floor Mount

Price	\$140.00 per	Price	\$140.00 per
-------	---------------------	-------	---------------------





Weave room divider

Pricing

To price Weave, select a size-based SKU and add the price of two base plates. Frame color and panel inserts do no impact the price.

Typicals

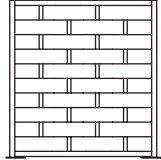
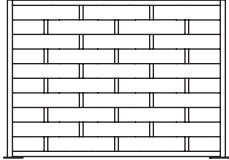
Weave is available in 4 unique size-based styles. Weave is available in 12 acoustic finishes noted as -XX- in the product SKU.

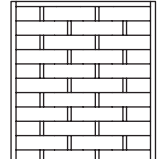
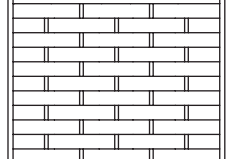
	52" WIDE	76" WIDE											
53" TALL													
													
	WE-XX-LH-4	WE-XX-LH-6											
	<table border="1"> <tr> <td>Dimensions</td> <td>52" W x 53" H</td> </tr> <tr> <td>Panels</td> <td>(10) Weave Panels</td> </tr> <tr> <td>Price</td> <td>\$1,480.00</td> </tr> </table>	Dimensions	52" W x 53" H	Panels	(10) Weave Panels	Price	\$1,480.00	<table border="1"> <tr> <td>Dimensions</td> <td>76" W x 53" H</td> </tr> <tr> <td>Panels</td> <td>(10) Weave Panels</td> </tr> <tr> <td>Price</td> <td>\$2,145.00</td> </tr> </table>	Dimensions	76" W x 53" H	Panels	(10) Weave Panels	Price
Dimensions	52" W x 53" H												
Panels	(10) Weave Panels												
Price	\$1,480.00												
Dimensions	76" W x 53" H												
Panels	(10) Weave Panels												
Price	\$2,145.00												
78" TALL													
													
	WE-XX-FH-4	WE-XX-FH-6											
	<table border="1"> <tr> <td>Dimensions</td> <td>52" W x 78" H</td> </tr> <tr> <td>Panels</td> <td>(15) Weave Panels</td> </tr> <tr> <td>Price</td> <td>\$2,040.00</td> </tr> </table>	Dimensions	52" W x 78" H	Panels	(15) Weave Panels	Price	\$2,040.00	<table border="1"> <tr> <td>Dimensions</td> <td>76" W x 78" H</td> </tr> <tr> <td>Panels</td> <td>(15) Weave Panels</td> </tr> <tr> <td>Price</td> <td>\$2,945.00</td> </tr> </table>	Dimensions	76" W x 78" H	Panels	(15) Weave Panels	Price
Dimensions	52" W x 78" H												
Panels	(15) Weave Panels												
Price	\$2,040.00												
Dimensions	76" W x 78" H												
Panels	(15) Weave Panels												
Price	\$2,945.00												

Panels

Weave divider panels are available in a variety of acoustic felt finishes. For a complete list of finishes, please visit loftwall.com/weave. All panel finishes are included in the price of Weave.

Name	Description
PET felt (AKUS-WEAVE-*SIZE*-*COLOR*)	Sound-absorbing panel

Frame Colors

Weave is available in 3 standard frame finishes, Black (BK), White (WH), and Silver (SV) noted in place of -XX- in the product SKU. All standard frame finishes are priced the same. Custom colors may be available upon request.

Finish	Price
Silver, White, and Black	Price included in product.
Custom Colors and Finishes	Contact us for a quote!

Bases

Weave is available with a variety of bases. These are available in 3 finishes: Black (BK), White (WH), and Silver (SV) noted in place of -XX- in the product SKU. All base finishes are included in the price. Bases are not included in the listed price under the typical section.

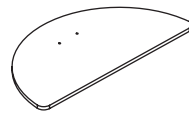

BP-01-XX

13" Half Moon

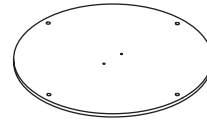

BP-02-XX

12" Floor Mount

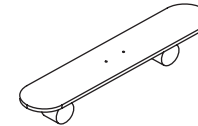

BP-03-XX

15" Caster



BP-04-XX

12" Link

Price	\$140.00 per	Price	\$140.00 per	Price	\$140.00 per	Price	\$140.00 per
-------	---------------------	-------	---------------------	-------	---------------------	-------	---------------------

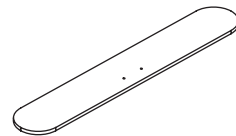

BP-05-XX

12" Flush



BP-06-XX/BP-07-XX

6" Floor/Non-Floor Mount

Price	\$140.00 per	Price	\$140.00 per
-------	---------------------	-------	---------------------

Web room divider

Pricing

To price Web, select a size-based SKU and add the price of 2 base plates and the price of each needed panel. Frame color and panel inserts do no impact the price of Web.

Typicals

Web is available in 6 unique size-based styles. Web is available in 3 finishes noted as -XX- in the product SKU.

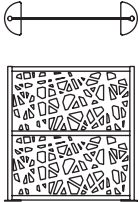
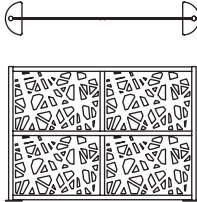
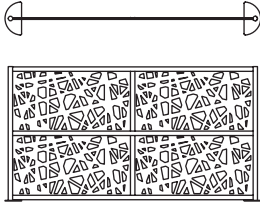
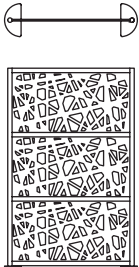
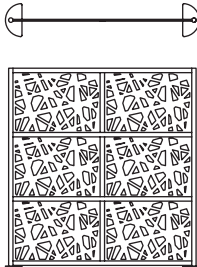
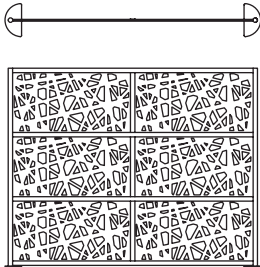
	52" WIDE	76" WIDE	100" WIDE
53" TALL			
	FW-XX-LH-4-3.0	FW-XX-LH-6-3.2-2	FW-XX-LH-8-3.2
	Dimensions 52" W x 53" H	Dimensions 76" W x 53" H	Dimensions 100" W x 53" H
	Panels 2x4	Panels (4) 2x3	Panels (4) 2x4
	Price \$990.00	Price \$1,430.00	Price \$1,870.00
78" TALL			
	FW-XX-FH-4-4.0	FW-XX-FH-6-4.3-2	FW-XX-FH-8-4.3
	Dimensions 52" W x 78" H	Dimensions 76" W x 78" H	Dimensions 100" W x 78" H
	Panels (3) 2x4	Panels (6) 2x3	Panels (6) 2x4
	Price \$1,335.00	Price \$1,890.00	Price \$2,365.00

Panels

Web divider panels are in 3 standard finishes. All panel finishes are priced the same.

Name	Description	2x2	2x3	2x4
WEB-HDPE-*SIZE*-*COLOR*	Knife cut design panel	\$185.00	\$275.00	\$370.00

Frame Colors

Weave is available in 3 standard frame finishes, Black (BK), White (WH), and Silver (SV) noted in place of -XX- in the product SKU. All standard frame finishes are priced the same. Custom colors may be available upon request.

Finish	Price
Silver, White, and Black	Price included in product.
Custom Colors and Finishes	Contact us for a quote!

Bases

Web is available with a variety of bases. These are available in 3 finishes: Black (BK), White (WH), and Silver (SV) noted in place of -XX- in the product SKU. All base finishes are included in the price. Bases are not included in the listed price under the typical section.

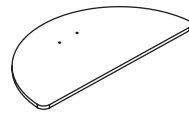

BP-01-XX
13" Half Moon

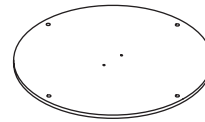

BP-02-XX
12" Floor Mount

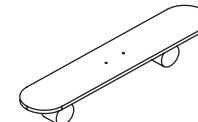

BP-03-XX
15" Caster

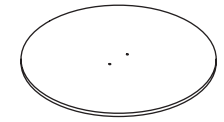

BP-04-XX
12" Link

Price	\$140.00 per	Price	\$140.00 per	Price	\$140.00 per	Price	\$140.00 per
-------	---------------------	-------	---------------------	-------	---------------------	-------	---------------------

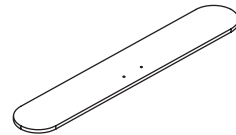

BP-05-XX
12" Flush



BP-06-XX/BP-07-XX
6" Floor/Non-Floor Mount

Price	\$140.00 per	Price	\$140.00 per
-------	---------------------	-------	---------------------



Desk Dividers

Freestanding and clamp-on desk dividers for offices, hospitals, and schools. Available with acoustic felt, plexiglass, or dry-erase finishes. All desk privacy panels are made in the USA and ship quickly.

DESK DIVIDERS

Arc.....	31
Counter Shield.....	33
Desk Shield.....	37
Hide.....	39
Hitch.....	41
Parallel.....	43
Shelter.....	47



SCAN FOR MORE VISUAL
REFERENCES OF FEATURED
PRODUCTS

Arc desk divider

Pricing

Arc is priced by configuration. Each fixed kit includes pre-routed PET panels, powder-coated white brackets, and construction-grade adhesive tape. For long-term hold, Liquid Nail or a comparable adhesive is required (installer supplied). Finish selection determines the final SKU. Custom PET colors available; contact Loftwall for pricing and lead times.

Typicals

Arc SKUs follow a consistent naming structure based on configuration, size, orientation (if applicable), and PET finish. Wrap kits use the format ARC-WRAP-[SM/MD/LG]-[COLOR], while Corner kits follow ARC-CORNER-[SM/MD]-[LT/RT]-[COLOR]. Custom kits will include -CUS at the end. Each kit includes all panels, powder-coated brackets, and construction-grade adhesive tape. Arc also requires Liquid Nail or a comparable adhesive for long-term bonding—installer supplied. What you see is what you get.

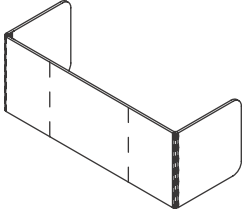
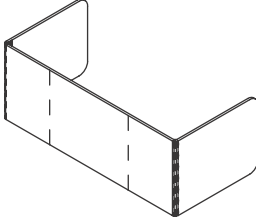
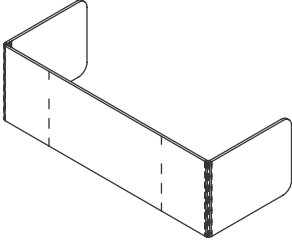
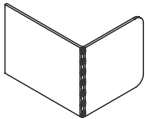
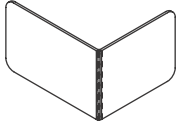
WRAP						
	ARC-WRAP-SM-XX	ARC-WRAP-MD-XX	ARC-WRAP-LG-XX			
	Dimensions	60"W x 24"D x 23"H	Dimensions	60"W x 30"D x 23"H	Dimensions	72"W x 30"D x 23"H
	Price	\$1,015.00	Price	\$1,125.00	Price	\$1,230.00
CORNER			<i>NOTE: CORNER KIT ILLUSTRATIONS SHOW LEFT-FACING ORIENTATION. RIGHT-FACING KITS ARE ALSO AVAILABLE AT THE SAME PRICE.</i>			
	ARC-CORNER-SM-LT-XX	ARC-CORNER-LG-LT-XX				
	Dimensions	30"W x 24"D x 23"H			Dimensions	36"W x 30"D x 23"H
	Price	\$590.00			Price	\$695.00

What's Included

Each Arc kit includes everything needed for installation; no guesswork required.

- 1 PET panel (Corner) or 3 PET panels (Wrap), routed for bracket installation
- 2 brackets (Corner) or 4 brackets (Wrap), powder-coated steel
- Construction-grade adhesive tape (Tape-03)

Note: Liquid Nail or a comparable construction adhesive is required for long-term panel bonding. This is not provided and must be supplied by the installer.

Finishes

Available in a curated selection of Loftwall's 9mm PET colors (total panel thickness = 18mm). Not all PET finishes are offered—see Material Finish Guide for approved options.

FINISH	PRICE
Curated Selection of PET Colors	Included
White Powder Coated Bracket	Included
Custom PET Colors	Contact us for a quote!
Duotone Panels	Contact us for a quote!
Printed Panels	Contact us for a quote!

Want more contrast or a bold brand statement? Duotone and printed panel options let Arc speak louder than words.

Counter Shield desk divider

Pricing

To price Counter Shield, select a style and size. All Counter Shields are available with clear or frosted panels. Both panels are priced the same. Frame color, bases and panel inserts do not impact the price of the Counter Shield.

Typicals

Counter Shields are available in 4 standard styles: Lite, Basic, Classic, and Wrap. SKUs with the "-NP" suffix have no pass through window.

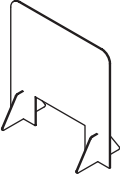
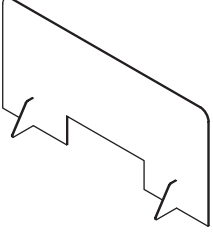
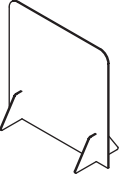
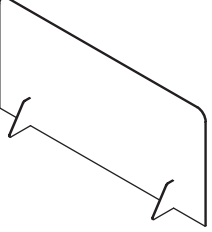
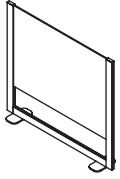
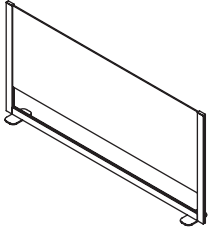
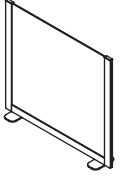
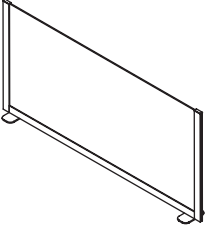
LITE				
	CS-SM-LITE	CS-LG-LITE	CS-SM-LITE-NP	CS-LG-LITE-NP
	Dimensions 24" W x 24" H	Dimensions 48" W x 24" H	Dimensions 24" W x 24" H	Dimensions 48" W x 24" H
	Price \$240.00	Price \$475.00	Price \$240.00	Price \$475.00
BASIC				
	CS-XX-SM-BASC	CS-XX-LG-BASC	CS-XX-SM-BASC-NP	CS-XX-LG-BASC-NP
	Dimensions 32" W x 28" H	Dimensions 59" W x 28" H	Dimensions 32" W x 28" H	Dimensions 59" W x 28" H
	Price \$445.00	Price \$795.00	Price \$445.00	Price \$795.00

Typicals Continued

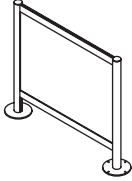
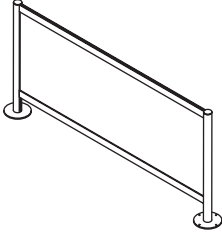
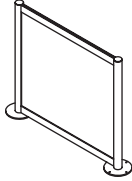
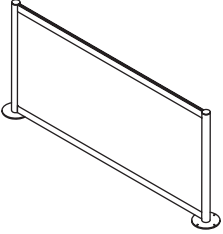
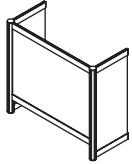
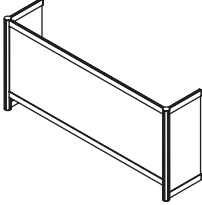
CLASSIC				
	CS-XX-SM-CLSC	CS-XX-LG-CLSC	CS-XX-SM-CLSC-NP	CS-XX-LG-CLSC-NP
	Dimensions 36" W x 28" H	Dimensions 63" W x 28" H	Dimensions 36" W x 28" H	Dimensions 63" W x 28" H
	Price \$610.00	Price \$1,015.00	Price \$610.00	Price \$1,015.00
WRAP				
	CS-XX-SM-WRAP	CS-XX-LG-WRAP		
	Dimensions 32" W x 28" H	Dimensions 59" W x 28" H		
	Price \$720.00	Price \$1,175.00		

Frame Colors

Basic, Classic and Wrap Counter Shields are available in 3 standard frame finishes, Black (BK), White (WH), and Silver (SV) noted in place of -XX- in the product SKU. All standard frame finishes are priced the same. Custom colors may be available upon request.

Finish	Price
Silver, White, and Black	Price included in product.
Custom Colors and Finishes	Contact us for a quote!

Counter Shield desk divider

Panels

All Counter Shields use acrylic insert panels. Panels may be clear or frosted. Both panels are priced the same.

Name	Description	Price
Frosted or Clear Acrylic (AC-*SIZE*-*CL/FC*)	Translucent panel	Price included in product.

Bases

Counter Shield is available with one base option. The base is available in 3 finishes: Black (BK), White (WH), and Silver (SV) noted in place of -XX- in the product SKU. All base finishes are included in the price. Bases are included in the listed price under the typical section.



BP-06-XX/BP-07-XX

6" Floor/Non-Floor Mount

Price *Included*

Desk Shield desk divider

Pricing

To price Desk Shield, select a size-based SKU. Frame color and panel inserts do not impact the price of the Desk Shield.

Typicals

Desk Shield is available in 6 unique size-based styles. Desk Shield is available in 2 panel finishes noted as -XX- in the product SKU.

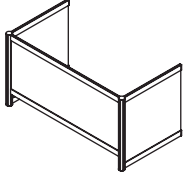
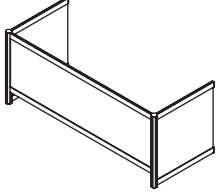
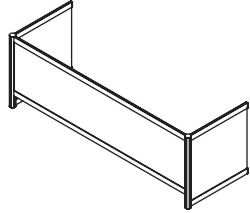
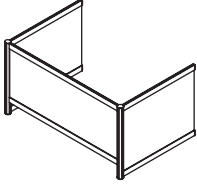
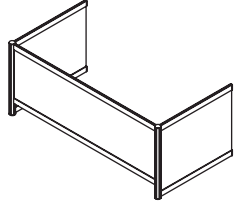
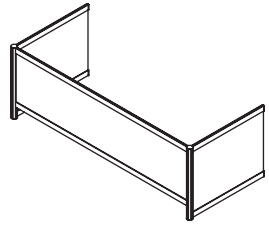
	48" WIDE	60" WIDE	72" WIDE
24" DEPTH			
	DS-XX-48-24	DS-XX-60-24	DS-XX-72-24
	Dimensions 48" W x 24" H x 24" D	Dimensions 60" W x 24" H x 24" D	Dimensions 72" W x 24" H x 24" D
	Panels (3) Panels	Panels (3) Panels	Panels (3) Panels
	Price \$1,535.00	Price \$1,495.00	Price \$1,590.00
30" DEPTH			
	DS-XX-48-30	DS-XX-60-30	DS-XX-72-30
	Dimensions 48" W x 24" H x 30" D	Dimensions 60" W x 24" H x 30" D	Dimensions 72" W x 24" H x 30" D
	Panels (3) Panels	Panels (3) Panels	Panels (3) Panels
	Price \$1,660.00	Price \$1,605.00	Price \$1,705.00

Panels

Desk Shield is available with clear or frosted acrylic panel inserts. Panel inserts are already included in the listed SKU price.

Name	Description
Frosted or Clear Acrylic (AC-*SIZE*-*CL/FC*)	Translucent panel

Frame Colors

Desk Shield is available in 3 standard frame finishes, Black (BK), White (WH), and Silver (SV) noted in place of -XX- in the product SKU. All standard frame finishes are priced the same. Custom colors may be available upon request.

Finish	Price
Silver, White, and Black	Price included in product.
Custom Colors and Finishes	Contact us for a quote!

Hide desk divider

Pricing

All hides are priced the same, regardless of selected acoustic felt finish.

Typicals

Hide is available in 1 size, with 24 9mm acoustic finishes noted as -XX- in the product SKU. Custom colors may be available upon request.

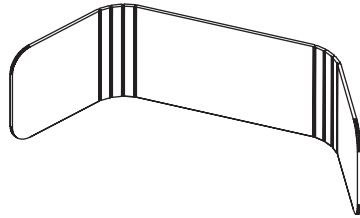

LW-HIDE-XX

63.25" W x 15" H

\$145.00

Panels

Hide is available in a variety of acoustic felt finishes. For a complete list of finishes, please visit loftwall.com/hide

Name	Description
PET felt (PATTERN-AKUS-64/84-FINISH)	Sound-absorbing panel

Hitch desk divider

Pricing

All Hitch dividers are priced based on their size-based SKU. Frame color, bases and panel inserts do no impact the price of the Hitch.

Typicals

Hitch dividers are available in 6 size-based styles. Hitch is available in 6 finishes noted as -XX- in the product SKU.

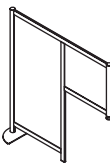
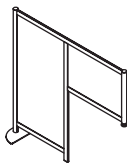
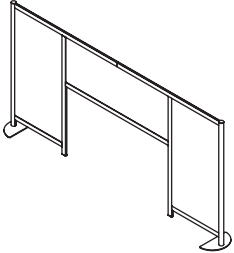
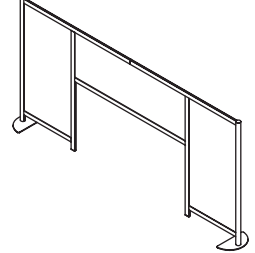
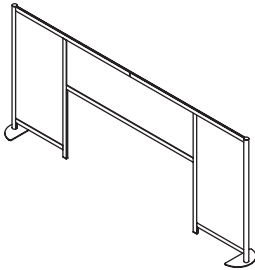
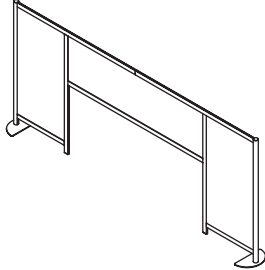
SINGLE				
	<p>HT-XX-24-SNG</p> <p>Dimensions 51" W x 53" H</p> <hr/> <p>(1) 2X4 Panels</p> <p>Panels (1) 24" Desk</p> <hr/> <p>Price \$1,135.00</p>	<p>HT-XX-30-SNG</p> <p>Dimensions 57" W x 53" H</p> <hr/> <p>(1) 2X4 Panels</p> <p>Panels (1) 30" Desk</p> <hr/> <p>Price \$1,330.00</p>		
DOUBLE				
	<p>HT-XX-51-DBL</p> <p>Dimensions 108" W x 53" H</p> <hr/> <p>(2) 2X4 Panels</p> <p>Panels (1) 51" Double</p> <hr/> <p>Price \$2,275.00</p>	<p>HT-XX-55-DBL</p> <p>Dimensions 112" W x 53" H</p> <hr/> <p>(2) 2X4 Panels</p> <p>Panels (1) 55" Double</p> <hr/> <p>Price \$2,530.00</p>	<p>HT-XX-63-DBL</p> <p>Dimensions 120" W x 53" H</p> <hr/> <p>(2) 2X4 Panels</p> <p>Panels (1) 63" Double</p> <hr/> <p>Price \$2,785.00</p>	<p>HT-XX-67-DBL</p> <p>Dimensions 124" W x 53" H</p> <hr/> <p>(2) 2X4 Panels</p> <p>Panels (1) 67" Double</p> <hr/> <p>Price \$2,890.00</p>

Panels

Hitch panels are available in a variety of finishes. For Hitch, all panels are priced the same.

Name	Description
PET felt (AKUS-)	Sound-absorbing panel
Twinwall Polycarbonate (TW-)	Translucent panel
Frosted or Clear Acrylic (AC-)	Translucent panel
Nonmagnetic Dry Erase (DEP-)	White dry erase surface
Cutout Composite Panel (PEG-) (WEB-)	Pegboard & Web
Laminates (SC-)	Woodgrain and solid finishes
Magnetic Dry Erase (DEM-)	White dry erase surface
Blox Panel (BLX-)	Up to 85% sound absorption
Custom Artwork Panel	Custom branded panels
Custom Material Panel	3Form, Lumicor, Wilsonart

Frame Colors

Hitch is available in 3 standard frame finishes, Black (BK), White (WH), and Silver (SV) noted in place of -XX- in the product SKU. All standard frame finishes are priced the same. Custom colors may be available upon request.

Name	Price
Silver, White, and Black	Price included in product.
Custom Colors and Finishes	Contact us for a quote!

Hitch desk divider

Bases

Hitch only offers one base option available in 3 finishes: Black (BK), White (WH), and Silver (SV) noted in place of -XX- in the product SKU. All base finishes are included in the price. Bases are not included in the listed price under the typical section.

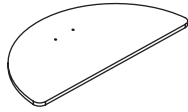

BP-01-XX

13" Half Moon

Price	<i>Included</i>
-------	-----------------

Parallel desk divider

Pricing

To price Parallel, select a style, size, and finish. All Parallel panels come with the necessary install hardware.

Typicals

Parallel panels are available in 8 standard sizes. Side-to-side panels are available in 1 width, 2 heights. Modesty panels are available in 3 widths, 2 heights. Parallel is available in 24 finishes noted as -XX- in the product SKU.

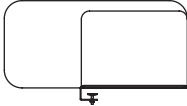
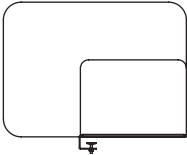
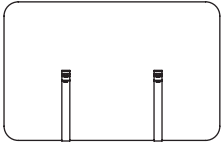
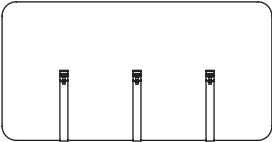
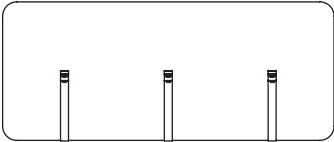
	SIDE-TO-SIDE		MODESTY PANEL			
						
	PA-WH-LF/RT-15H S-PAR-XX-SIZE-XX	PA-WH-LF/RT-24H S-PAR-XX-SIZE-XX	PA-WH-MOD-15H-48W	PA-WH-MOD-15H-60W	PA-WH-MOD-15H-72W	
	Dimensions	30" W x 15" H	Dimensions	46" W x 30" H	Dimensions	57" W x 30" H
	Acoustic PET panel	\$465.00	Acoustic PET panel	\$760.00	Acoustic PET panel	\$955.00
	Dimensions	30" W x 24" H	Dimensions	70" W x 30" H	Dimensions	70" W x 30" H
	Acoustic PET panel	\$505.00	Acoustic PET panel	\$1,140.00	Acoustic PET panel	\$1,140.00

Typicals Continued

MODESTY PANEL

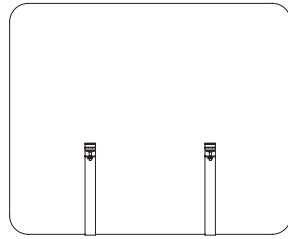

PA-WH-MOD-24H-48W

Dimensions 46" W x 39" H

Acoustic PET panel **\$850.00**

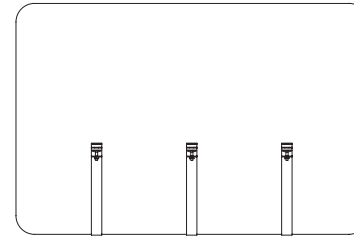

PA-WH-MOD-24H-60W

Dimensions 57" W x 39" H

Acoustic PET panel **\$1,055.00**

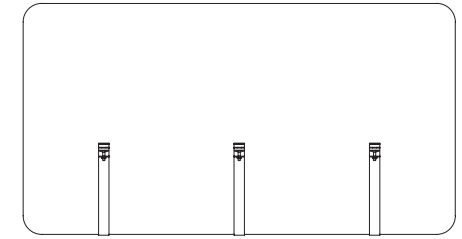

PA-WH-MOD-24H-72W

Dimensions 70" W x 39" H

Acoustic PET panel **\$1,230.00**

Hardware

All Parallel panels come with the necessary install hardware at no additional cost.

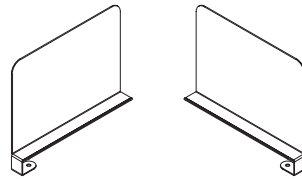

SIDE DEVICE ORGANIZER

18" W x 13" H x 3" D



MODESTY BRACKET

1.75" W x 15" H x 4.25" D

Panels

All Parallel panels are built with two 3/8" acoustic PET panels adhered to each other. The Parallel panel can be either monotone or duo tone at no additional charge. For a complete list of available finishes, please visit loftwall.com/parallel.

Name

Description

Acoustic PET

Sound-absorbing panel

Shelter desk divider

Pricing

To price Shelter, select a sized-based SKU and a panel material.

Side-to-Side Typicals

Shelter is available in 5 unique size-based styles. Shelter offers 24 9mm acoustic finishes noted as -XX- in the product SKU.

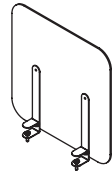

ST-XX-STD-24

Dimensions 24" W x 24" H

PET **\$245.00**

Acrylic **\$455.00**

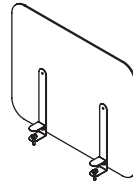

ST-XX-STD-30

Dimensions 30" W x 24" H

PET **\$300.00**

Acrylic **\$495.00**

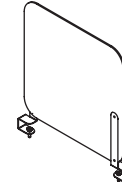

ST-XX-FNT-24

Dimensions 24" W x 24" H

PET **\$245.00**

Acrylic **\$455.00**

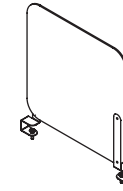

ST-XX-FNT-30

Dimensions 30" W x 24" H

PET **\$300.00**

Acrylic **\$495.00**

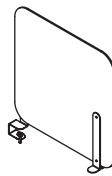

ST-XX-FNT-FREE-24

Dimensions 24" W x 24" H

PET **\$245.00**

Acrylic **\$455.00**

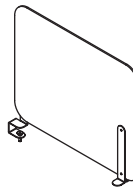

ST-XX-FNT-FREE-30

Dimensions 30" W x 24" H

PET **\$300.00**

Acrylic **\$495.00**

Back Panel Typicals

BACK PANEL

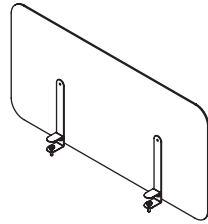

ST-XX-STD-48

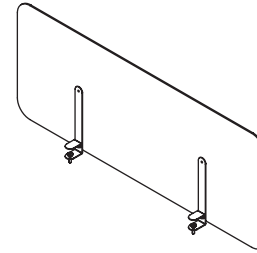

ST-XX-STD-60

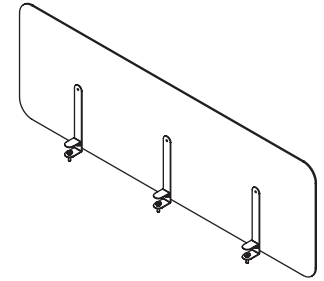

ST-XX-STD-72

Dimensions	48" W x 24" H
PET	\$335.00
Acrylic	\$590.00

Dimensions	60" W x 24" H
PET	\$425.00
Acrylic	\$740.00

Dimensions	72" W x 24" H
PET	\$490.00
Acrylic	\$820.00

Panels

Shelter panels can be outfitted with acoustic felt or acrylic panels. For a complete list of finishes, please visit loftwall.com/shelter.

Name	Description	24x24	24x30	Back Panel
A-kus-tik (AKUS-)	Sound-absorbing panel	Included	Included	Included
Frosted or Clear Acrylic (AC-)	Translucent panel	Included	Included	Included

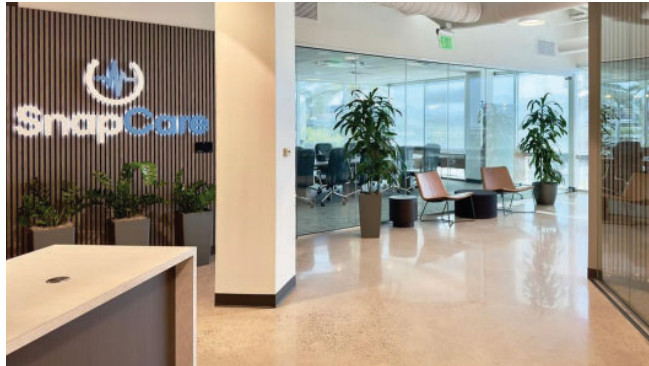
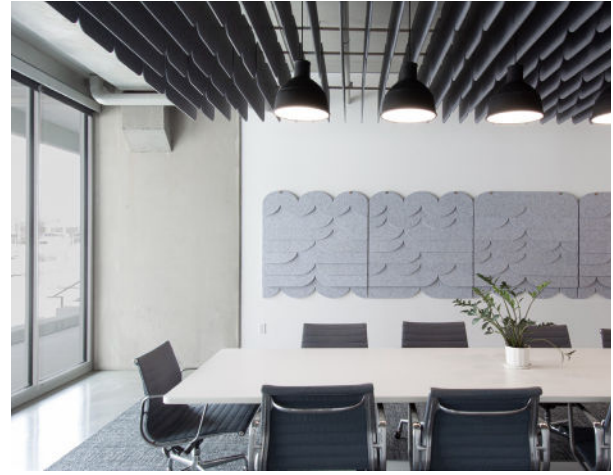
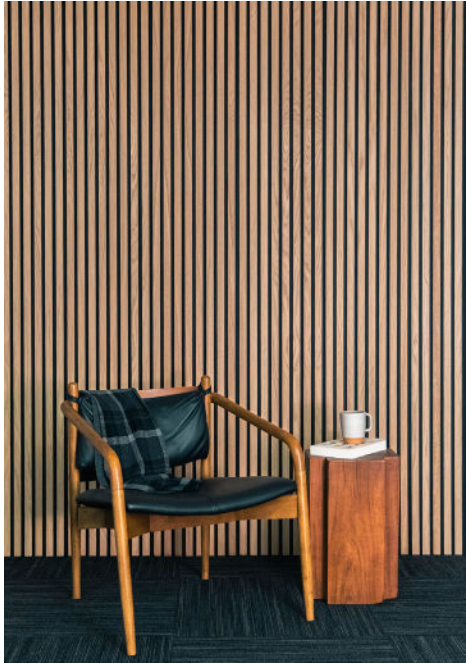

Acoustic Wallcoverings

Felt acoustic wall cladding for offices, hospitals, and schools. Available with a variety of thicknesses, finishes and acoustic properties.

ACOUSTIC WALLCOVERINGS

Arbor.....	51
Tango.....	53
Tempo	61



SCAN FOR MORE VISUAL
REFERENCES OF FEATURED
PRODUCTS

Arbor wallcoverings

Pricing

Available in 3 finishes, 2 styles and 2 size, the only price determining variable is style. All standard panels are priced the same and all slim panels are priced the same.

Typicals

Arbor panels are available in standard or slim thickness. Slim panels have a thinner profile than standard panels. Arbor is available in 3 finishes noted as -XX- in the product SKU.

**ARBOR
2x8 SLIM**

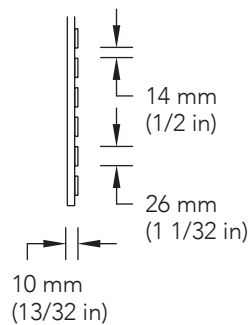
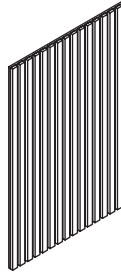

AR-28-SLIM-XX-XX

Dimensions 24" W x 95" H

Panel(s) (1) Arbor Panel

Price **\$375.00**

**ARBOR
2x8**

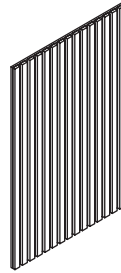

AR-28-STD-XX-XX

Dimensions 24" W x 95" H

Panel(s) (1) Arbor Panel

Price **\$455.00**

**ARBOR
2x10 SLIM**

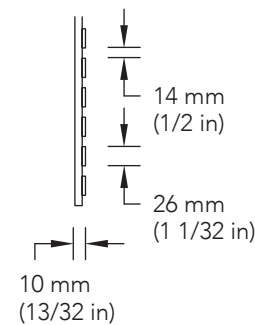
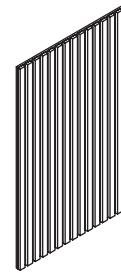

AR-210-SLIM-XX-XX

Dimensions 24" W x 118" H

Panel(s) (1) Arbor Panel

Price **\$560.00**

**ARBOR
2x10**

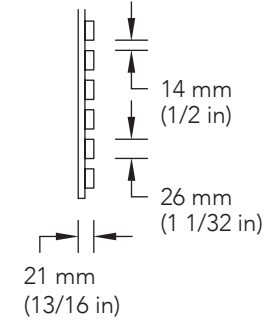
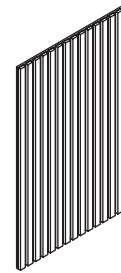

AR-210-STD-XX-XX

Dimensions 24" W x 118" H

Panel(s) (1) Arbor Panel

Price **\$685.00**

How to Price Arbor Wallcovering

- **Linear-Foot Pricing (LF):** Use the List Price/LF column when you know your total run length in feet. It assumes full-height panels (no cuts) and tells you exactly what you'll pay per foot of wall.
- **Square-Foot Pricing (SF):** Use the List Price/SF column when you're budgeting by wall area (panel width × height). This assumes panels aren't cut—once you trim a panel, leftover pieces may not fit elsewhere.
- **Panel Dimensions:** Each 2×8 panel is 24" W × 96" H = 15.5 sq ft of coverage; each 2×10 panel is 24" W × 120" H = 19.37 sq ft. These areas drive the SF calculation below.

Size	List Price	Total LF	Total SF	List Price/LF	List Price/SF
Arbor 2x8 Slim	\$375.00	1.9683	15.50 sq ft	\$190.52	\$24.20
Arbor 2x8	\$455.00	1.9683	15.50 sq ft	\$231.16	\$29.36
Arbor 2x10 Slim	\$560.00	1.9683	19.37 sq ft	\$284.50	\$28.91
Arbor 2x10	\$685.00	1.9683	19.37 sq ft	\$348.01	\$35.36

Arbor Reserve wallcoverings

Pricing

Available in 20 finishes, 2 styles and 2 sizes. Arbor Reserve has a minimum order quantity of 50 panels. Lead times can take up to 12+ weeks.

Typicals

Arbor Reserve panels are available in standard or slim thickness. Slim panels have a thinner profile than standard panels. Arbor is available in 5 wood finishes and 4 PET backers, both noted as -XX- in the product SKU.

ARBOR RESERVE 2x8 SLIM	ARBOR RESERVE 2x8	ARBOR RESERVE 2x10 SLIM	ARBOR RESERVE 2x10
AR-28-SLIM-XX-XX	AR-28-STD-XX-XX	AR-210-SLIM-XX-XX	AR-210-STD-XX-XX
Dimensions 24" W x 95" H	Dimensions 24" W x 95" H	Dimensions 24" W x 118" H	Dimensions 24" W x 118" H
Panel(s) (1) Arbor Panel	Panel(s) (1) Arbor Panel	Panel(s) (1) Arbor Panel	Panel(s) (1) Arbor Panel
Price \$410.00	Price \$505.00	Price \$620.00	Price \$755.00

How to Price Arbor Reserve Wallcovering

- **Linear-Foot Pricing (LF):** Use the List Price/LF column when you know your total run length in feet. It assumes full-height panels (no cuts) and tells you exactly what you'll pay per foot of wall.
- **Square-Foot Pricing (SF):** Use the List Price/SF column when you're budgeting by wall area (panel width × height). This assumes panels aren't cut—once you trim a panel, leftover pieces may not fit elsewhere.
- **Panel Dimensions:** Each 2×8 panel is 24" W × 96" H = 15.5 sq ft of coverage; each 2×10 panel is 24" W × 120" H = 19.37 sq ft. These areas drive the SF calculation below.

Size	List Price	Total LF	Total SF	List Price/LF	List Price/SF
Arbor Reserve 2x8 Slim	\$410.00	1.9683 ft	15.50 sq ft	\$208.30	\$26.46
Arbor Reserve 2x8	\$505.00	1.9683 ft	15.50 sq ft	\$256.56	\$32.59
Arbor Reserve 2x10 Slim	\$620.00	1.9683 ft	19.37 sq ft	\$314.99	\$32.00
Arbor Reserve 2x10	\$755.00	1.9683 ft	19.37 sq ft	\$383.57	\$38.97





Tango wallcoverings

Pricing

While specific Tango panel prices vary by shape and size. Panel pricing varies by shape and size, with an average of \$33 per square foot across the collection.

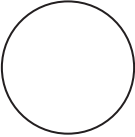
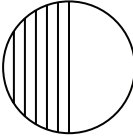
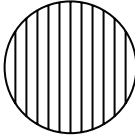
Typicals

Tango is available in eight unique shapes, two unique sizes (large and small), and a variety of styles. For an added design flair, select panels can be outfitted with a series of beveled lines - we refer to this pattern as "corduroy". Panels with full corduroy will have SKUs featuring "FP", half corduroy panels will be "HP", and no corduroy will be "NP". The X's in each SKU refer to the finish of the panel. For a complete list of finishes, please visit loftwall.com/tango.

CIRCLE - LARGE					
	AKUS-TANGO-CIR-LG-NP-XX	AKUS-TANGO-CIR-LG-HP-XX	AKUS-TANGO-CIR-LG-FP-XX		
Dimensions	23.75" x 23.75"	Dimensions	23.75" x 23.75"	Dimensions	23.75" x 23.75"
Price of 1	\$110.00	Price of 1	\$110.00	Price of 1	\$110.00
CIRCLE - SMALL					
	AKUS-TANGO-CIR-SM-NP-XX	AKUS-TANGO-CIR-SM-HP-XX	AKUS-TANGO-CIR-SM-FP-XX		
Dimensions	11.875" x 11.875"	Dimensions	11.875" x 11.875"	Dimensions	11.875" x 11.875"
Price of 1	\$28.00	Price of 1	\$28.00	Price of 1	\$28.00

HALF CIRCLE - LARGE



AKUS-TANGO-HCR-LG-NP-XX

Dimensions 23.75" x 11.875"

Price of 1 \$57.00

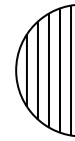

AKUS-TANGO-HCR-LG-HP-XX

Dimensions 23.75" x 11.875"

Price of 1 \$57.00

HALF CIRCLE - SMALL



AKUS-TANGO-HCR-SM-NP-XX

Dimensions 5.9375" x 11.875"

Price of 1 \$15.00



AKUS-TANGO-HCR-SM-FP-XX

Dimensions 5.9375" x 11.875"

Price of 1 \$15.00

TRIANGLE - LARGE

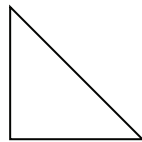

AKUS-TANGO-TRI-LG-NP-XX

Dimensions 23.75" x 23.75"

Price of 1 \$77.00

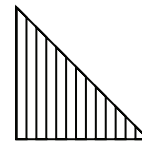

AKUS-TANGO-TRI-LG-FP-XX

Dimensions 23.75" x 23.75"

Price of 1 \$77.00

Tango wallcoverings

Typicals
Continued

TRIANGLE - SMALL



AKUS-TANGO-TRI-SM-NP-XX

Dimensions 11.875" x 11.875"

Price of 1 **\$19.00**



AKUS-TANGO-TRI-SM-FP-XX

Dimensions 11.875" x 11.875"

Price of 1 **\$19.00**

PLANK - LARGE



AKUS-TANGO-PLA-LG-NP-XX

Dimensions 47.50" x 11.87"

Price of 1 **\$147.00**



AKUS-TANGO-PLA-LG-FP-XX

Dimensions 47.50" x 11.87"

Price of 1 **\$147.00**

PLANK - SMALL



AKUS-TANGO-PLA-SM-NP-XX

Dimensions 23.75" x 5.93"

Price of 1 **\$37.00**



AKUS-TANGO-PLA-SM-FP-XX

Dimensions 23.75" x 5.93"

Price of 1 **\$37.00**

SQUARE - LARGE



AKUS-TANGO-SQU-LG-NP-XX

Dimensions 23.75" x 23.75"

Price of 1 \$147.00

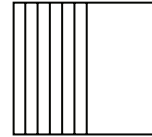

AKUS-TANGO-SQU-LG-HP-XX

Dimensions 23.75" x 23.75"

Price of 1 \$147.00

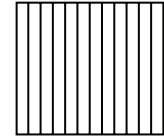

AKUS-TANGO-SQU-LG-FP-XX

Dimensions 23.75" x 23.75"

Price of 1 \$147.00

SQUARE - SMALL



AKUS-TANGO-SQU-SM-NP-XX

Dimensions 11.875" x 11.875"

Price of 1 \$37.00



AKUS-TANGO-SQU-SM-HP-XX

Dimensions 11.875" x 11.875"

Price of 1 \$37.00



AKUS-TANGO-SQU-SM-FP-XX

Dimensions 11.875" x 11.875"

Price of 1 \$37.00

RECTANGLE - LARGE



AKUS-TANGO-REC-LG-NP-XX

Dimensions 11.875" x 23.75"

Price of 1 \$77.00

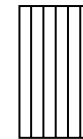

AKUS-TANGO-REC-LG-FP-XX

Dimensions 11.875" x 23.75"

Price of 1 \$77.00

Tango wallcoverings

Typicals
Continued

RECTANGLE - SMALL



AKUS-TANGO-REC-SM-NP-XX

Dimensions 5.9375" x 11.875"

Price of 1 **\$19.00**



AKUS-TANGO-REC-SM-FP-XX

Dimensions 5.9375" x 11.875"

Price of 1 **\$19.00**

HEXAGON - LARGE

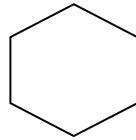

AKUS-TANGO-HEX-LG-NP-XX

Dimensions 27.4325" x 23.75"

Price of 1 **\$137.00**

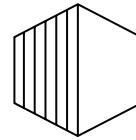

AKUS-TANGO-HEX-LG-HP-XX

Dimensions 27.4325" x 23.75"

Price of 1 **\$137.00**

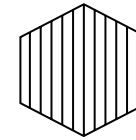

AKUS-TANGO-HEX-LG-FP-XX

Dimensions 27.4325" x 23.75"

Price of 1 **\$137.00**

HEXAGON - SMALL



AKUS-TANGO-HEX-SM-NP-XX

Dimensions 13.6875" x 11.875"

Price of 1 **\$34.00**



AKUS-TANGO-HEX-SM-HP-XX

Dimensions 13.6875" x 11.875"

Price of 1 **\$34.00**



AKUS-TANGO-HEX-SM-FP-XX

Dimensions 13.6875" x 11.875"

Price of 1 **\$34.00**

SQUARE - LARGE

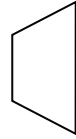

AKUS-TANGO-TRA-LG-NP-XX

Dimensions 27.4325" x 11.875"

Price of 1 **\$67.00**

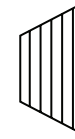

AKUS-TANGO-TRA-LG-FP-XX

Dimensions 27.4325" x 11.875"

Price of 1 **\$67.00**

SQUARE - SMALL



AKUS-TANGO-TRA-SM-NP-XX

Dimensions 13.6875" x 5.9375"

Price of 1 **\$17.00**



AKUS-TANGO-TRA-SM-FP-XX

Dimensions 13.6875" x 5.9375"

Price of 1 **\$17.00**

Panels

Tango is available in a variety of acoustic felt finishes. For a complete list of finishes, please visit loftwall.com/tango.

Name	Description
PET felt (AKUS-)	Sound-absorbing panel

Tempo wallcoverings

Pricing

To price a Tempo wall grid, select a thickness-based SKU. While attached panels are available in a variety in finishes and patterns, all panels are priced the same.

Typicals

Tempo wall grids are available with eight, 9mm or 12mm acoustic felt panels. Tempo is available in 24 finishes noted as -XX- in the product SKU.

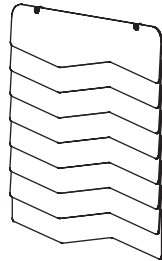

TM-RAW-WALL-XX

Dimensions	48" W x 49" H
Panel(s)	(8) Tempo Panels
9mm Price	\$1,250.00
12mm Price	\$1,335.00

How to Price Tempo Wallcovering

- **Linear-Foot Pricing (LF):** Use the List Price/LF column when you know your total run length in feet. It assumes full-height ceiling grid panels (no partial cuts) and shows what you'll pay per foot of ceiling span.
- **Square-Foot Pricing (SF):** Use the List Price/SF column when you're budgeting by ceiling area (panel width × length). This assumes panels aren't trimmed—once you cut a panel, leftover pieces may not fit elsewhere.
- **Panel Dimensions:** Each panel is 48" W × 192" L (4 ft × 16 ft) = 16 sq ft of coverage. These areas drive the SF calculation below.

Size	List Price	Total LF	Total SF	List Price/LF	List Price/SF
9mm White Ash	\$1,250.00	4 ft	16 sq ft	\$312.50	\$78.13
1/2" White Ash	\$1,335.00	4 ft	16 sq ft	\$333.75	\$83.44

Panels

Tempo panels are available in a variety of acoustic felt finishes and patterns. For a complete list of finishes and patterns, please visit loftwall.com/tempo. All panel finishes and patterns have the same price.

Name	Description
PET felt (AKUS-PANEL-*STYLE*-FINISH)	Sound-absorbing panel

Grid Typicals

Please note, multiple Tempo ceiling grids can be installed next to each other to create continuous runs.

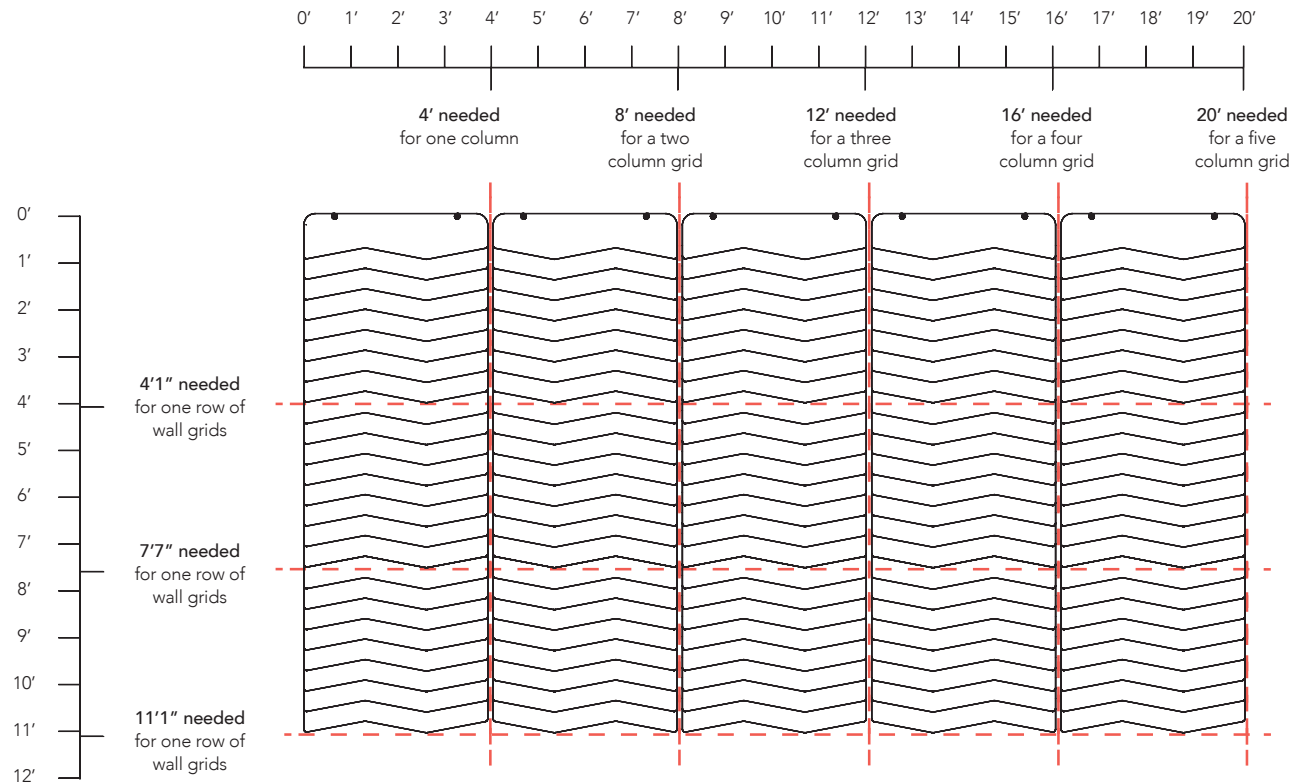

Tempo wallcoverings

Available Designs

Tempo wall grids are available in 4 standard designs. All panels are priced the same, regardless of selected design.

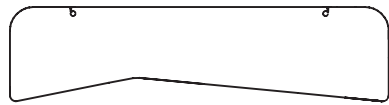

Turn 1



Turn 2

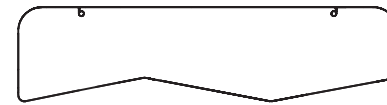

Turn 3



Tilt 1



Tilt 2

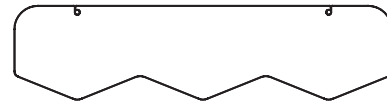

Tilt 3

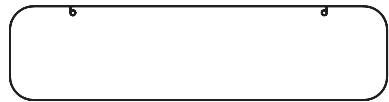

Tab 1



Tab 2

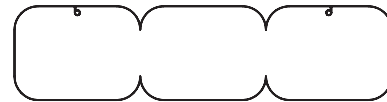

Tab 3



Tide 1

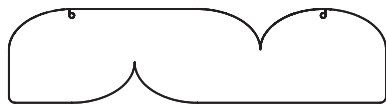

Tide 2



Tide 3

Hardware

Tempo wall grids are shipped with the necessary mounting brackets at no additional cost.

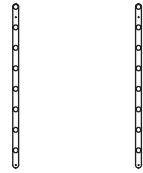

MOUNTING BRACKET

33" W x 42" H

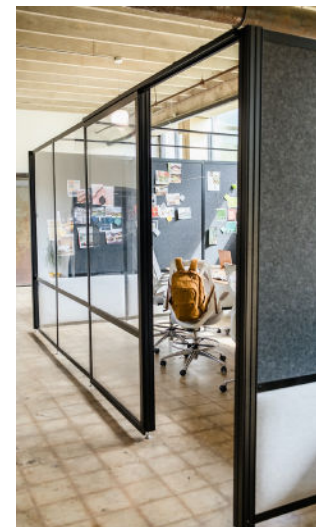
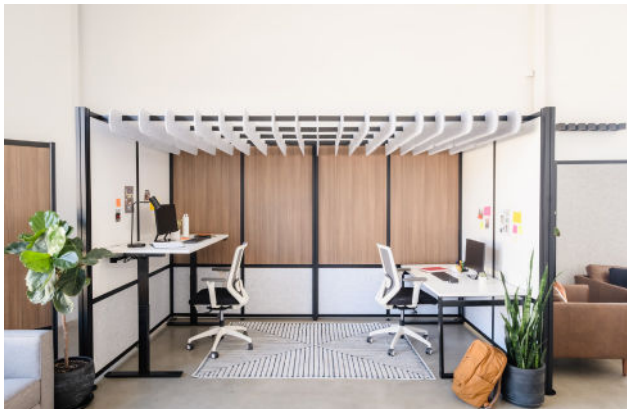

Architectural

Wall-mounted, ceiling-mounted, ceiling track, and floor-mounted room dividers for offices, hospitals, and schools.

Screens are made in the USA and ship quickly.

ARCHITECTURAL

Glide	67
Hover	71
Pivot.....	73
Rooms.....	75



SCAN FOR MORE VISUAL
REFERENCES OF FEATURED
PRODUCTS







Glide architectural

Pricing

To price Glide, select a size-based SKU and request a quote from us to determine the right panel and size for your space.

Typicals

Glide is available in 9 unique size-based styles. Glide offers 12 finishes noted as -XX- in the product SKU.

	78" TALL	103" TALL	128" TALL
50" WIDE			
	GL-XX-4-3	GL-XX-4-4	GL-XX-4-5
	Frame <u>\$1,090.00</u>	Frame <u>\$1,320.00</u>	Frame <u>\$1,710.00</u>
	Panel(s) (3) 2x4	Panel(s) (4) 2x4	Panel(s) (5) 2x4
	Level 1 Panels <u>\$1,600.00</u>	Level 1 Panels <u>\$2,000.00</u>	Level 1 Panels <u>\$2,560.00</u>
	Level 2 Panels <u>\$1,960.00</u>	Level 2 Panels <u>\$2,480.00</u>	Level 2 Panels <u>\$3,160.00</u>
74" WIDE			
	GL-XX-6-3	GL-XX-6-4	GL-XX-6-5
	Frame <u>\$1,710.00</u>	Frame <u>\$2,095.00</u>	Frame <u>\$2,480.00</u>
	Panel(s) (6) 2x3	Panel(s) (8) 2x3	Panel(s) (10) 2x3
	Level 1 Panels <u>\$2,460.00</u>	Level 1 Panels <u>\$3,095.00</u>	Level 1 Panels <u>\$3,730.00</u>
	Level 2 Panels <u>\$3,000.00</u>	Level 2 Panels <u>\$3,815.00</u>	Level 2 Panels <u>\$4,630.00</u>

Typicals Continued

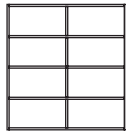
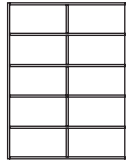
	78" TALL	103" TALL	128" TALL
98" WIDE			
	GL-XX-8-3	GL-XX-8-4	GL-XX-8-5
	Frame	Frame	Frame
	\$2,030.00	\$2,480.00	\$2,950.00
	Panel(s)	Panel(s)	Panel(s)
(6) 2x4	(8) 2x4	(10) 2x4	
Level 1 Panels	Level 1 Panels	Level 1 Panels	
\$3,050.00	\$3,840.00	\$4,650.00	
Level 2 Panels	Level 2 Panels	Level 2 Panels	
\$3,770.00	\$4,800.00	\$5,850.00	

Frame Colors

Glide is available in 3 standard frame finishes, Black (BK), White (WH), and Silver (SV) noted in place of -XX- in the product SKU. All standard frame finishes are priced the same. Custom colors may be available upon request.

Name	Price
Silver, White, and Black	Price included in product.
Custom Colors and Finishes	Contact us for a quote!

Panels

Glide panels are available in a variety of finishes.

Level	Name	Description
1	PET felt (AKUS-)	Sound-absorbing panel
1	Twinwall Polycarbonate (TW-)	Translucent panel

Glide architectural

Panels Continued

Level	Name	Description
2	Frosted or Clear Acrylic (AC-)	Translucent panel
2	Cutout Composite Panel (WEB-)	Web
2	Laminates (SC-)	Woodgrain and solid finishes
2	Chisel (*PATTERN*-AKUS-)	Acoustic knife cut design panels

Hardware

All Glide panels need overhead track to attach to. Please note the price change for track at 60" in length.

Name	Description	Level
GL-TRK-60	<60" Single Track Section	\$115.00
GL-TRK-94	>60" Single Track Section	\$225.00

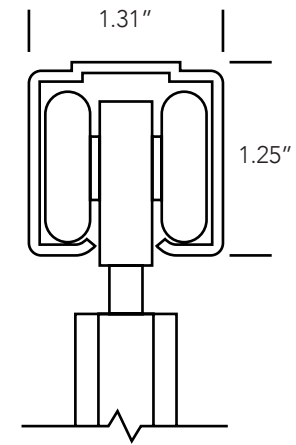

Hover architectural

Pricing

To price Hover, select a size-based SKU and add the price of selected infill panels as well as the base. There is no price difference for various frame finishes.

Typicals

Hover is available in 3 unique size-based styles. Hover offers 3 frame finishes noted as -XX- in the product SKU.

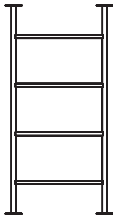
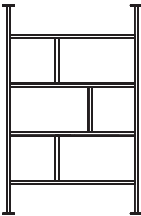
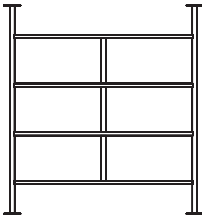
	52" WIDE	76" WIDE	100" WIDE
78" TALL			
	HV-XX-4	HV-XX-6	HV-XX-8
Dimensions	52" W x 78" H	76" W x 78" H	100" W x 78" H
Panel(s)	(3) 2x4	(3) 2x2, (3) 2x4	(6) 2x4
Price	\$1,685.00	\$2,220.00	\$2,725.00

Panels

Hover divider panels are compatible with a variety of panels. Please note the price difference of each panel type. Small panels are 2'x2', medium panels are 2'x3', and large panels are 2'x4'.

Level	Name	Description	2x2	2x4
1	PET felt (AKUS-)	Sound-absorbing panel	\$85.00	\$170.00
1	Twinwall Polycarbonate (TW-)	Translucent panel	\$85.00	\$170.00
2	Frosted or Clear Acrylic (AC-)	Translucent panel	\$145.00	\$280.00
2	Nonmagnetic Dry Erase (DEP-)	White dry erase surface	\$145.00	\$280.00

Panels Continued

Level	Name	Description	2x2	2x4
2	Cutout Composite Panel (PEG-) (WEB-)	Pegboard & Web	\$145.00	\$280.00
2	Laminates (SC-)	Woodgrain and solid finishes	\$145.00	\$280.00
2	Chisel (*PATTERN*-AKUS-)	Acoustic knife cut design panels	\$145.00	\$280.00
3	Magnetic Dry Erase (DEM-)	White dry erase surface	\$415.00	\$820.00
3	Custom Artwork Panel	Custom branded panels	quote	quote
3	Custom Material Panel	3Form, Lumicor, Wilsonart	quote	quote

Frame Colors

Hover is available in 3 standard frame finishes, Black (BK), White (WH), and Silver (SV) noted in place of -XX- in the product SKU. All standard frame finishes are priced the same. Custom colors may be available upon request.

Finish	Price
Silver, White, and Black	Price included in product.
Custom Colors and Finishes	Contact us for a quote!

Bases

Hover is available with two standard base options. There are 3 available finishes: Black (BK), White (WH), and Silver (SV) noted in place of -XX- in the product SKU. All base finishes are included in the price. Bases are not included in the listed price under the typical section.



BP-06-XX

6" Floor/Non-Floor Mount

Price \$140.00 per

Pivot architectural

Pricing

To price Pivot, select a size-based SKU and a delivery method. Pivots are shipped fully assembled.

Typicals

Pivot is available in 6 unique size-based styles. Pivot offers 3 frame finishes noted as -XX- in the product SKU.

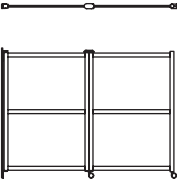
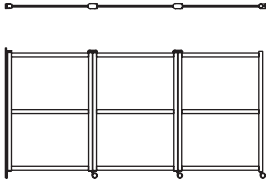
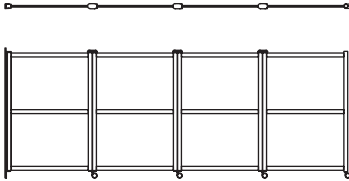
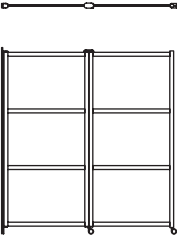
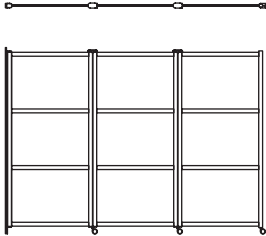
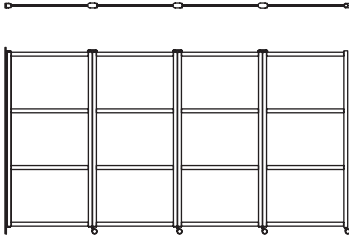
	77" WIDE	115" WIDE	153" WIDE
57" TALL			
	PV-XX-LH-2S	PV-XX-LH-3S	PV-XX-LH-4S
	Dimensions <u>77" W x 57" H</u>	Dimensions <u>115" W x 57" H</u>	Dimensions <u>153" W x 57" H</u>
	Panel(s) <u>(4) 2x3</u>	Panel(s) <u>(6) 2x3</u>	Panel(s) <u>(8) 2x3</u>
	Price <u>\$4,305.00</u>	Price <u>\$6,470.00</u>	Price <u>\$8,620.00</u>
82" TALL			
	PV-XX-FH-2S	PV-XX-FH-3S	PV-XX-FH-4S
	Dimensions <u>77" W x 82" H</u>	Dimensions <u>115" W x 82" H</u>	Dimensions <u>153" W x 82" H</u>
	Panel(s) <u>(6) 2x3</u>	Panel(s) <u>(9) 2x3</u>	Panel(s) <u>(12) 2x3</u>
	Price <u>\$5,450.00</u>	Price <u>\$8,165.00</u>	Price <u>\$10,885.00</u>

Panels

Pivot walls are compatible with a variety of panel inserts. For Pivot, all panel inserts are priced the same.

Name	Description
PET felt (AKUS-)	Sound-absorbing panel
Twinwall Polycarbonate (TW-)	Translucent panel
Frosted or Clear Acrylic (AC-)	Translucent panel
Nonmagnetic Dry Erase (DEP-)	White dry erase surface
Cutout Composite Panel (PEG-) (WEB-)	Pegboard & Web
Laminates (SC-)	Woodgrain and solid finishes
Chisel (*PATTERN*-AKUS-)	Acoustic knife cut design panels
Magnetic Dry Erase (DEM-)	White dry erase surface
Custom Artwork Panel	Custom branded panels
Custom Material Panel	3Form, Lumicor, Wilsonart

Frame Colors

Pivot is available in 3 standard frame finishes, Black (BK), White (WH), and Silver (SV) noted in place of -XX- in the product SKU. All standard frame finishes are priced the same. Custom colors may be available upon request.

Finish	Price
Silver, White, and Black	Price included in product.
Custom Colors and Finishes	Contact us for a quote!

Hardware

Pivot comes standard with non-locking casters. Locking casters can be added for no additional price.

Rooms architectural

Pricing

To price a Room, determine the number of 2', 3', and 4' walls and doors you require and any additional mounting needed (floor wall mounting available). While walls and doors are available in various styles and with frame and panel finishes, all styles and finishes are priced the same.

Wall Typicals

Rooms can be divided into 5 modular SKUs: 2' walls, 3' walls, 3' doors, 4' walls and 4' doors. Rooms is available in 3 frame finishes noted as -XX- in the product SKU; and features 3 wall styles noted as the last X in the SKU. For additional wall styles please visit loftwall.com/rooms.



RM-XX-2-8.X

Dimensions	2' W x 92" H
2' Wall	\$1,745.00
2' Door	N/A



RM-XX-3/RM-DR-XX-3-8.X

Dimensions	3' W x 92" H
3' Wall	\$2,080.00
3' Door	\$3,205.00

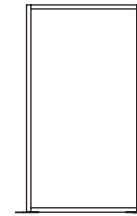

RM-XX-4/RM-DR-XX-4-8.X

Dimensions	4' W x 92" H
4' Wall	\$2,305.00
4' Door	\$3,430.00

Wall Styles

Each wall in Rooms can feature any one of our wall styles. All walls are priced the same, regardless of selected style.

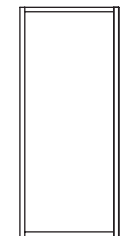

STYLE 1

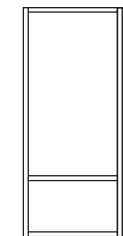

STYLE 2

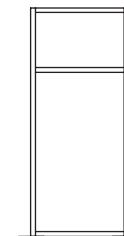

STYLE 3

Panels

Rooms are available with a variety of material. Please note, all Rooms panels are priced the same. For a comprehensive list of what panels are compatible with each wall style, please visit loftwall.com/rooms.

Level	Name	Description
1	PET felt (AKUS-)	Sound-absorbing panel
1	Twinwall Polycarbonate (TW-)	Translucent panel
2	Frosted or Clear Acrylic (AC-)	Translucent panel
2	Nonmagnetic Dry Erase (DEP-)	White dry erase surface
2	Cutout Composite Panel (PEG-) (WEB-)	Pegboard & Web
2	Laminates (SC-)	Woodgrain and solid finishes
2	Chisel (*PATTERN*-AKUS-)	Acoustic knife cut design panels
3	Magnetic Dry Erase (DEM-)	White dry erase surface
3	Blox Panel (BLX-)	Up to 85% sound absorption
3	Custom Artwork Panel	Custom branded panels
3	Custom Material Panel	3Form, Lumicor, Wilsonart

Frame Colors

Rooms is available in 3 standard frame finishes, Black (BK), White (WH), and Silver (SV) noted in place of -XX- in the product SKU. All standard frame finishes are priced the same. Custom colors may be available upon request.

Name	Price
Silver, White, and Black	Price included in product.
Custom Colors and Finishes	Contact us for a quote!

Rooms architectural

Shape Typicals

Simple designs intended to get the ball rolling, Rooms Shapes can be combined and even grow overtime as your space's needs change. Rooms Shapes is available in 3 frame finishes noted as -XX- in the product SKU. Rooms Shapes must be wall mounted for stability.

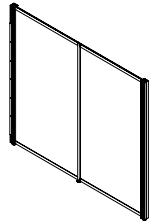

I SHAPE

2' Walls	\$1,166.00 per
3' Walls	\$1,980.00 per
4' Walls	\$2,195.00 per

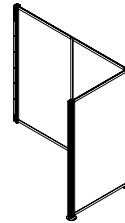

L SHAPE

2' Walls	\$1,166.00 per
3' Walls	\$1,980.00 per
4' Walls	\$2,195.00 per

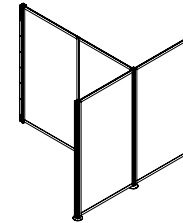

T SHAPE

2' Walls	\$1,166.00 per
3' Walls	\$1,980.00 per
4' Walls	\$2,195.00 per

Pod Typicals

6' x 6' focus spaces designed to move you into a productive flow state. Perfect as dedicated workspaces or retreat relaxation zones. Available in all wall styles. Rooms is available in 3 frame finishes noted as -XX- in the product SKU.

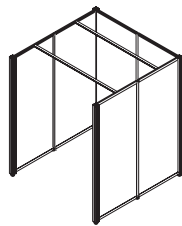

RM-XX-6X6-POD

Dimensions	72" W x 92" H x 72" D
Panels Used	(6) 3' Wide
Price	\$12,470.00

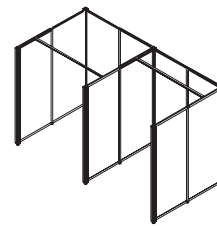

RM-XX-6X12-POD

Dimensions	144" W x 92" H x 72" D
Panels Used	(10) 3' Wide
Price	\$20,785.00

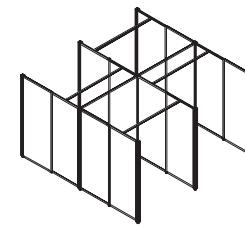

RM-XX-12X12-POD

Dimensions	144" W x 92" H x 144" D
Panels Used	(16) 3' Wide
Price	\$33,255.00

Small Group Typicals

Small group touchdown spaces. Designed and stylized for maximum collaboration for groups of 2 - 6 people. Available in all wall styles.

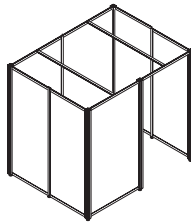

RM-XX-8X6-SMALLGROUP

Dimensions	96" W x 92" H x 72" D
Panels Used	(4) 3' Wide, (3) 4' Wide
Price	\$15,255.00

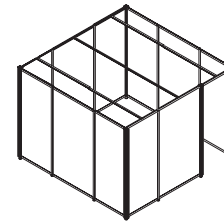

RM-XX-10X10-SMALLGROUP

Dimensions	120" W x 92" H x 120" D
Panels Used	(7) 3' Wide, (4) 4' Wide
Price	\$23,760.00

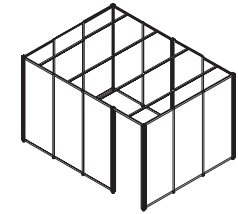

RM-XX-9X12-SMALLGROUP

Dimensions	144" W x 92" H x 108" D
Panels Used	(13) 3' Wide
Price	\$27,020.00

Large Group Typicals

Large group meeting spaces. War rooms for your team to collaborate in real time. Designed for groups of 7 or more. Available in all wall styles.

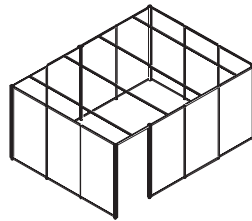

RM-XX-12X16-LARGEGROUP

Dimensions	192" W x 92" H x 144" D
Panels Used	(13) 4' Wide
Price	\$29,940.00

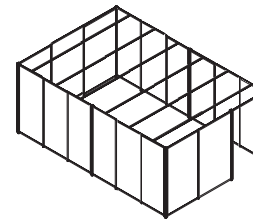

RM-XX-12X18-LARGEGROUP

Dimensions	1216" W x 92" H x 144" D
Panels Used	(12) 3' Wide, (5) 4' Wide
Price	\$36,455.00

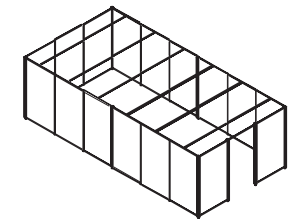

RM-XX-12X24-LARGEGROUP

Dimensions	288" W x 92" H x 144" D
Panels Used	(17) 4' Wide
Price	\$39,155.00

Rooms architectural

Baffle Typical

For an additional cost, acoustic ceiling baffles can be added to most Rooms. Baffles are priced by the square foot; on average, Rooms baffles are around \$33/SF if exactly quantity is unknown. There are two baffle types available: 9mm thick and 12mm thick. Room Baffles are available in 24 finishes.

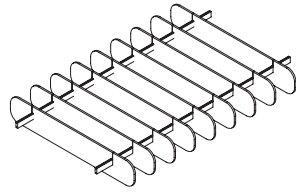

BAFFLES

3' Panels \$75.00 per panel

4' Panels \$100.00 per panel

Baffle Typical

Acoustic ceiling baffles can be added to part of or all of a Room.

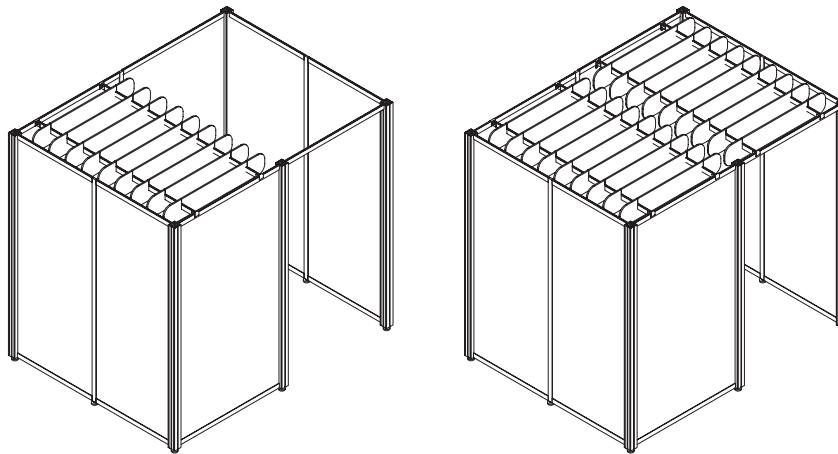

Mounting

All rooms come with freestanding level feet but in some configurations, floor and wall mounting may be required at an additional cost for stability purposes.

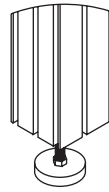

FREE STANDING

with leveling feet list price: \$0

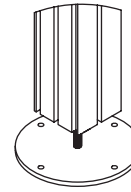

FLOOR MOUNTED

with leveling feet list price: \$250.00



WALL MOUNTED

with leveling feet list price: \$245.00

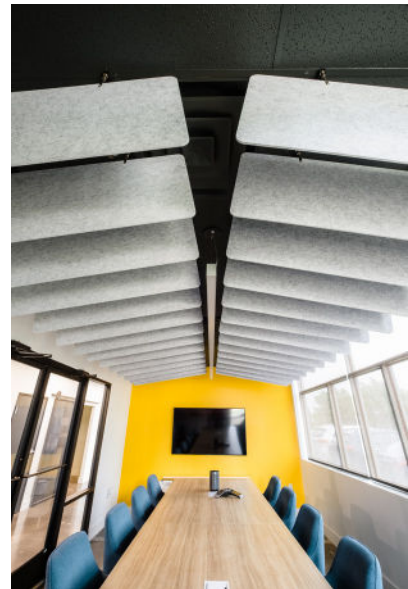
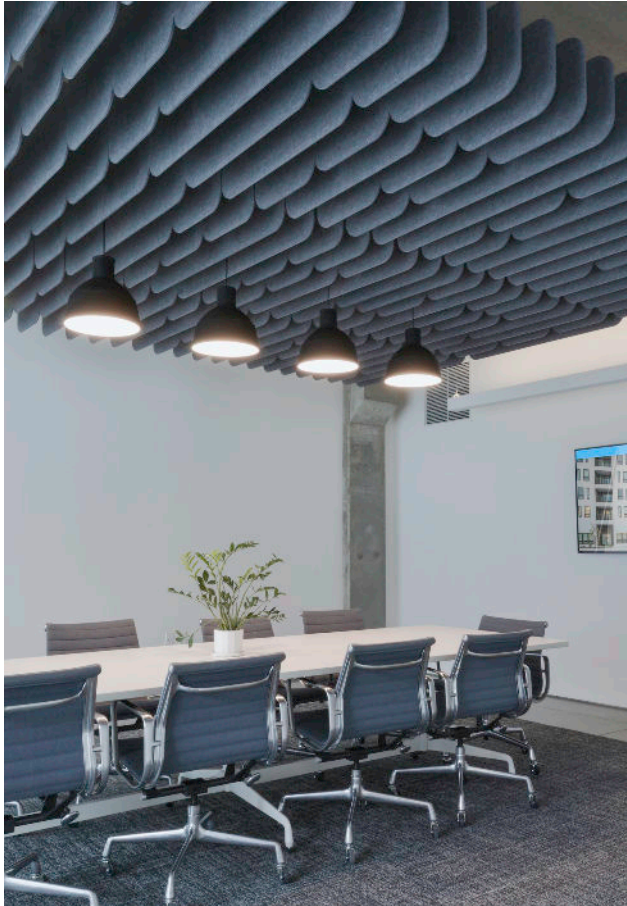

Acoustic Baffles

Commercial-grade acoustic baffle ceiling systems for offices, hospitals, and schools. All of our baffles are made in the USA and ship quickly.

ACOUSTIC BAFFLES

Gravity	83
Layer	87
Sky.....	89
Pocket.....	91
Tempo	93
Thicc	97
Thin.....	99



SCAN FOR MORE VISUAL
REFERENCES OF FEATURED
PRODUCTS





Gravity acoustic baffles

Pricing

To price Gravity, select a size-based SKU and mounting method. All like-sized panels are priced the same regardless of finish or cut pattern.

Dimensions

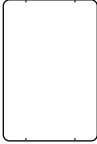
Gravity panels are available in 2 heights (67" and 91.5") and two thicknesses (9mm and 12mm).

9mm PET		12mm PET	
			
SLAB-AKUS-64-XX-9MM	SLAB-AKUS-84-XX-9MM	SLAB-AKUS-64-XX-1/2	SLAB-AKUS-84-XX-1/2
Dimensions 46" W x 67" H	Dimensions 46" W x 91.5" H	Dim. 46" W x 67" H	Dimensions 46" W x 91.5" H
Panel(s) (1) PET Panel	Panel(s) (1) PET Panel	Panel(s) (1) PET Panel	Panel(s) (1) PET Panel
Price \$670.00	Price \$790.00	Price \$790.00	Price \$900.00

Cut Patterns

Gravity has 12 different design options for both the full size panel and 3/4 size panel. All standard cut patterns are included in the price. For a 20% up charge, custom designs can be cut into Gravity panels. All custom designs must be approved before ordering.

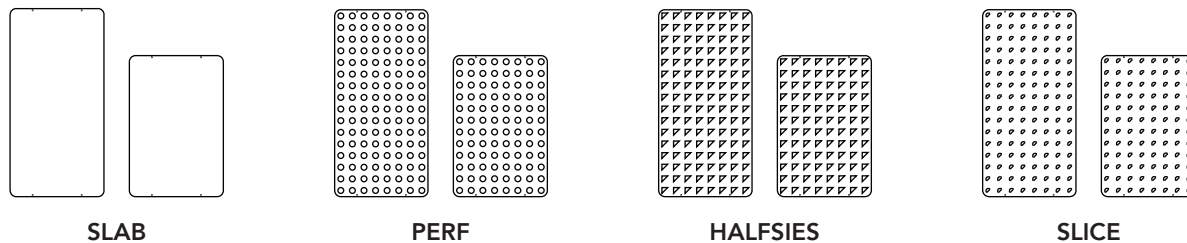

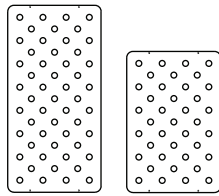

OFFSET

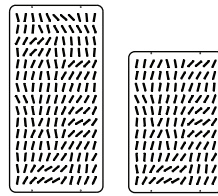

SCATTER

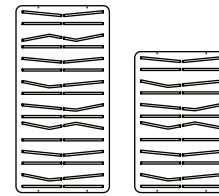

TURN

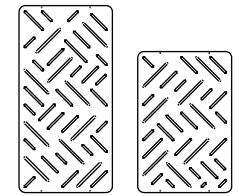

HATCH

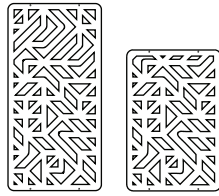

TRANSIT

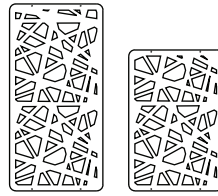

WEB

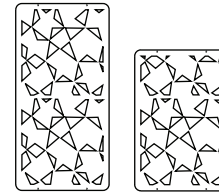

FRACTAL

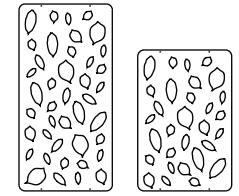

PETAL

Finish

9mm Gravity panels are available in 24 acoustic felt finishes with a variety of cut patterns, 12mm panels are only available in Marble and Charcoal. For a complete list of finishes and patterns, please visit loftwall.com/gravity. All panel finishes are included in the price.

Name	Description
PET felt (*PATTERN*-AKUS-64-*FINISH*)	Sound-absorbing panel

Mounting Typicals

Gravity has 4 ceiling mounting options and 2 floor mounting options, they can be combined to fit your space's needs.



GV-MOUNT-STND

Included



GV-MOUNT-TRACK

\$170.00



GV-MOUNT-TGRID

\$65.00

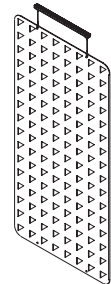

GV-MOUNT-UNIS

\$190.00

Gravity acoustic baffles

Mounting Typicals

Gravity has 4 ceiling mounting options and 2 floor mounting options, they can be combined to fit your space's needs.

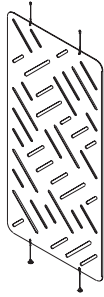

GV-MOUNT-STND-STND

\$225.00

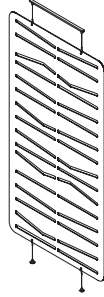

GV-MOUNT-TRACK-STND

\$335.00



GV-MOUNT-TGRID-STND

\$295.00

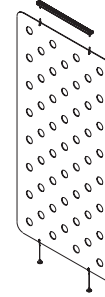

GV-MOUNT-UNIS-STND

\$415.00

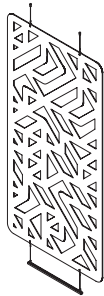

GV-MOUNT-STND-TRACK

\$335.00



GV-MOUNT-TRACK-TRACK

\$450.00



GV-MOUNT-TGRID-TRACK

\$405.00



GV-MOUNT-UNIS-TRACK

\$530.00

Mounting Hardware

All Gravity panels need to be ceiling mounted with either a ceiling coupler or a ceiling track. For added stability, panels can be floor mounted with a floor track or floor mount base.

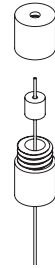

Single Point Coupler

Price *Included*

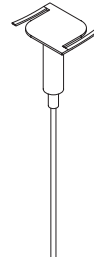

T-Grid Clip

Price *\$65.00 per*

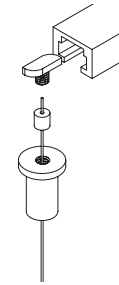

***Track/Track Coupler**

Price *\$170.00*

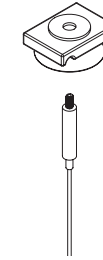

Unistrut Coupler

Price **\$190.00 per*



Floor Mount

Price *\$180.00 per*

*Track is shipped in 26" increments *Unistrut track is not provided

Layer acoustic baffles

Pricing

To price Layer, select a size-based SKU and mounting method.

Typicals

Layer is available in 3 sizes, all of which use 9mm thick PET.



BA-LAY-BASE-SML

Dimensions	47.5" W x 11.75" H x 11.5"
Panel(s)	(1) panel
Price	\$790.00 per

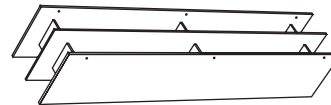

BA-LAY-BASE-MED

Dimensions	72" W x 11.75" H x 11.5"
Panel(s)	(1) panel
Price	\$1,015.00 per

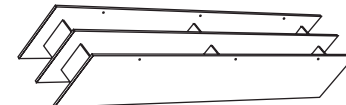

BA-LAY-BASE-LRG

Dimensions	92" W x 11.75" H x 11.5"
Panel(s)	(1) panel
Price	\$1,235.00 per

How to Price Layer Acoustic Baffles

Below is the cost per square foot of finished ceiling coverage, based on one panel plus its on-center spacing. Pick the column matching your desired spacing to see exactly what you'll pay per ft² of ceiling area.

Size	List Price	Dimensions (in)	6" Spacing (\$/sq ft)	12" Spacing (\$/sq ft)	24" Spacing (\$/sq ft)
Small	\$750.00	47.5" x 11.75"	\$121.55	\$81.36	\$44.82
Medium	\$965.00	72" x 11.75"	\$107.11	\$74.04	\$42.89
Large	1,175.00	92" x 11.75"	\$103.73	\$72.77	\$43.19

Note: "6" Spacing" means panels hung 6 inches on center (panel depth + 6" equals the module width). Columns for 12" and 24" spacing show how your cost per ft² drops as panels are spaced farther apart.

Mounting

Layer needs to be ceiling mounted with either a ceiling coupler, ceiling track or clip.



CEILING COUPLER

Price Included

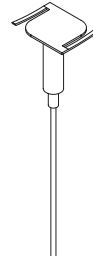

T-GRID CLIP

Price \$65.00 per

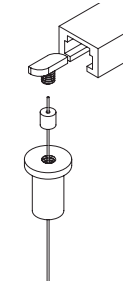

TMU COUPLER & TRACK

Price \$625.00

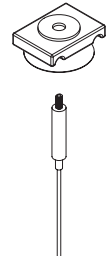

UNISTRUT COUPLER

Price *\$190.00 per

*Unistrut tracks are not included

Panels

Layer is available in a variety of acoustic felt finishes. For a complete list of finishes please visit loftwall.com/layer. All panel finishes and designs are priced the same.

Name	Description
PET felt (AKUS-)	Sound-absorbing panel

Designs

Layer has three different design options for all three of its sizes.



BASE

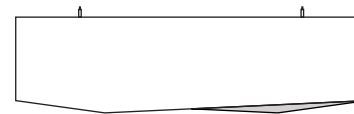

PITCH



WAVE

Sky acoustic baffles

Pricing

To price Sky, select a thickness-based SKU and mounting method. All like-sized panels are priced the same regardless of finish or cut pattern.

Typicals

Sky is available in 9mm and 12mm acoustic PET.

9mm PET

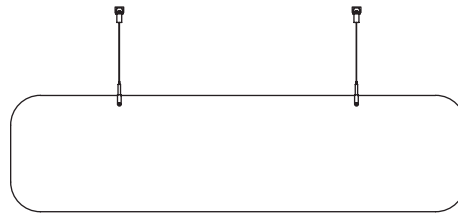

SLAB-AKUS-14-XX-9MM

Dimensions	46" W x 11.75" H x .25" D
Panel(s)	(1) Sky Panel
Price	\$190.00

12mm PET

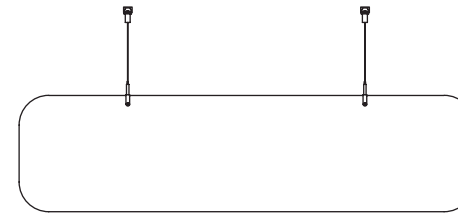

SLAB-AKUS-14-XX-12MM

Dimensions	46" W x 11.75" H x .5" D
Panel(s)	(1) Sky Panel
Price	\$210.00

How to Price Sky Acoustic Baffles

Below is the cost per square foot of finished ceiling coverage, based on one baffle panel plus its on-center spacing. Select the column matching your desired spacing to see exactly what you'll pay per ft² of ceiling area.

Size	List Price	Dimensions (in)	6" Spacing (\$/sq ft)	12" Spacing (\$/sq ft)	24" Spacing (\$/sq ft)
¼" PET	\$190.00	46" x 11.75"	\$82.79	\$38.18	\$16.04
½" PET	\$210.00	46" x 11.75"	\$89.85	\$41.80	\$17.65

Note: "6" Spacing" means panels hung 6 inches on-center (panel thickness + 6" equals the module width). The 12" and 24" columns show how your cost per ft² decreases as panels are spaced farther apart.

Mounting

All Sky panels need to be ceiling mounted with either a ceiling coupler or a ceiling track.



CEILING COUPLER

Price *Included*

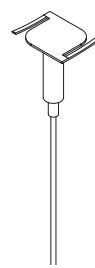

T-GRID CLIP

Price *\$65.00 per*

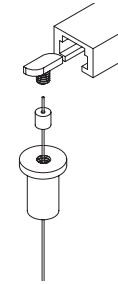

TMU COUPLER & TRACK

Price *\$625.00*

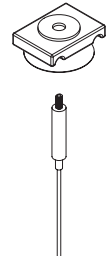

UNISTRUT COUPLER

Price **\$190.00 per*

*Unistrut tracks are not included

Finish

9mm Sky panels are available in 24 acoustic felt finishes with a variety of cut patterns, 12mm panels are only available in Marble and Charcoal. For a complete list of finishes and patterns, please visit loftwall.com/sky. All panel finishes are included in the price.

Name	Description
PET felt (*PATTERN*-AKUS-14-*FINISH*)	Sound-absorbing panel

Designs

Sky has 12 different design options for to choose from. For a 20% up charge, custom designs can be cut into Gravity panels. All custom designs must be approved before ordering.



SLAB

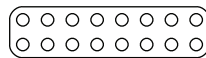

PERF

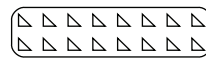

HALFSIES

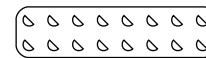

SLICE



OFFSET



SCATTER

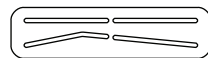

TURN

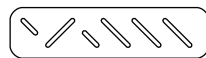

HATCH



TRANSIT



WEB

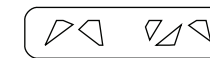

FRACTAL

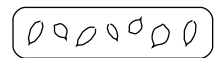

PETAL

Pocket acoustic baffles

Pricing

To price Pocket, select a size-based SKU and mounting method.

Typicals

Pocket is available in 3 sizes, all of which use 9mm thick PET.



BA-PKT-BASE-SML

Dimensions	47.5" W x 11.75" H x 2"
Panel(s)	(1) panel
Price	\$240.00 per



BA-PKT-BASE-MED

Dimensions	72" W x 11.75" H x 2"
Panel(s)	(1) panel
Price	\$370.00 per



BA-PKT-BASE-LRG

Dimensions	92" W x 11.75" H x 2"
Panel(s)	(1) panel
Price	\$485.00 per

How to Price Pocket Acoustic Baffles

Below is the cost per square foot of finished ceiling coverage, based on one Pocket panel plus its on-center spacing. Pick the column matching your desired spacing to see exactly what you'll pay per ft² of ceiling area.

Size	List Price	Dimensions (in)	6" Spacing (\$/sq ft)	12" Spacing (\$/sq ft)	24" Spacing (\$/sq ft)
Small	\$240.00	47.5" × 11.75"	\$80.71	\$41.47	\$18.59
Medium	\$370.00	72" × 11.75"	\$109.10	\$54.57	\$27.29
Large	\$485.00	92" × 11.75"	\$89.25	\$48.01	\$23.19

Note: "6" Spacing" means panels hung 6 inches on-center (panel thickness + 6" equals the module width). The 12" and 24" columns show how your cost per ft² decreases as panels are spaced farther apart.

Mounting

Pocket needs to be ceiling mounted with either a ceiling coupler, ceiling track or clip.

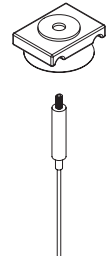
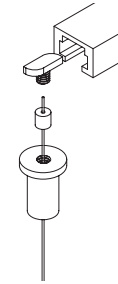
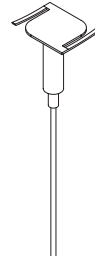
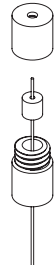

CEILING COUPLER

Price Included

T-GRID CLIP

Price \$65.00 per

TMU COUPLER & TRACK

Price \$625.00

UNISTRUT COUPLER

Price *\$190.00 per

*Unistrut tracks are not included

Panels

Pocket is available in a variety of acoustic felt finishes. For a complete list of finishes please visit loftwall.com/pocket. All panel finishes and designs are priced the same.

Name	Description
PET felt (AKUS-)	Sound-absorbing panel

Designs

Pocket has three different design options for all three of its sizes.



BASE

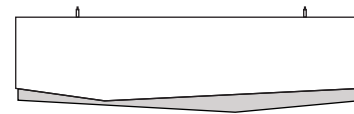

PITCH

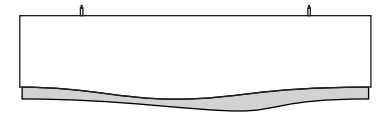

WAVE

Tempo acoustic baffles

Pricing

To price a Tempo ceiling grid, select a thickness-based SKU. While attached panels are available in a variety in finishes and patterns, all panels are priced the same.

Typicals

Tempo ceiling grids are available with eight 9mm or 12mm acoustic felt panels. Tempo is available in 24 finishes noted as -XX- in the product SKU.

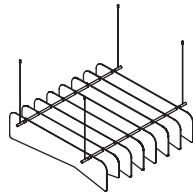

TM-XX-CEILING-XX-9MM

Dimensions	48" W x 12" H x 51" D
Panel(s)	(8) 9mm Panels
White Ash Dowel	\$1,250.00
Aspen Dowel	\$1,335.00
Ebony Dowel	\$1,335.00

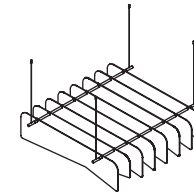

TM-XX-CEILING-XX-1/2

Dimensions	48" W x 12" H x 51" D
Panel(s)	(8) 12mm Panels
White Ash Dowel	\$1,505.00
Aspen Dowel	\$1,600.00
Ebony Dowel	\$1,600.00

How to Price Tempo Acoustic Baffles

Below is the cost per square foot of ceiling coverage for Tempo ceiling panels. Each panel covers a 4 ft x 4 ft (16 sq ft) area; use the Price / sq ft column when budgeting by ceiling area. This assumes panels aren't trimmed—once you cut a panel, leftover pieces may not fit elsewhere.

Size	List Price	Coverage (sq ft)	Price / sq ft
9mm White Ash	\$1,250.00	16.00	\$78.13
12mm White Ash	\$1,505.00	16.00	\$94.06
9mm Aspen/Ebony	\$1,335.00	16.00	\$83.44
12mm Aspen/Ebony	\$1,600.00	16.00	\$100.00

Panels

Tempo panels are available in a variety of acoustic felt finishes and patterns. For a complete list of finishes and patterns, please visit loftwall.com/tempo. All panel finishes and patterns have the same price.

Name	Description
PET felt (AKUS-PANEL-*STYLE*-*FINISH*)	Sound-absorbing panel

Grid Typicals

Please note, multiple Tempo ceiling grids can be installed next to each other to create continuous runs.

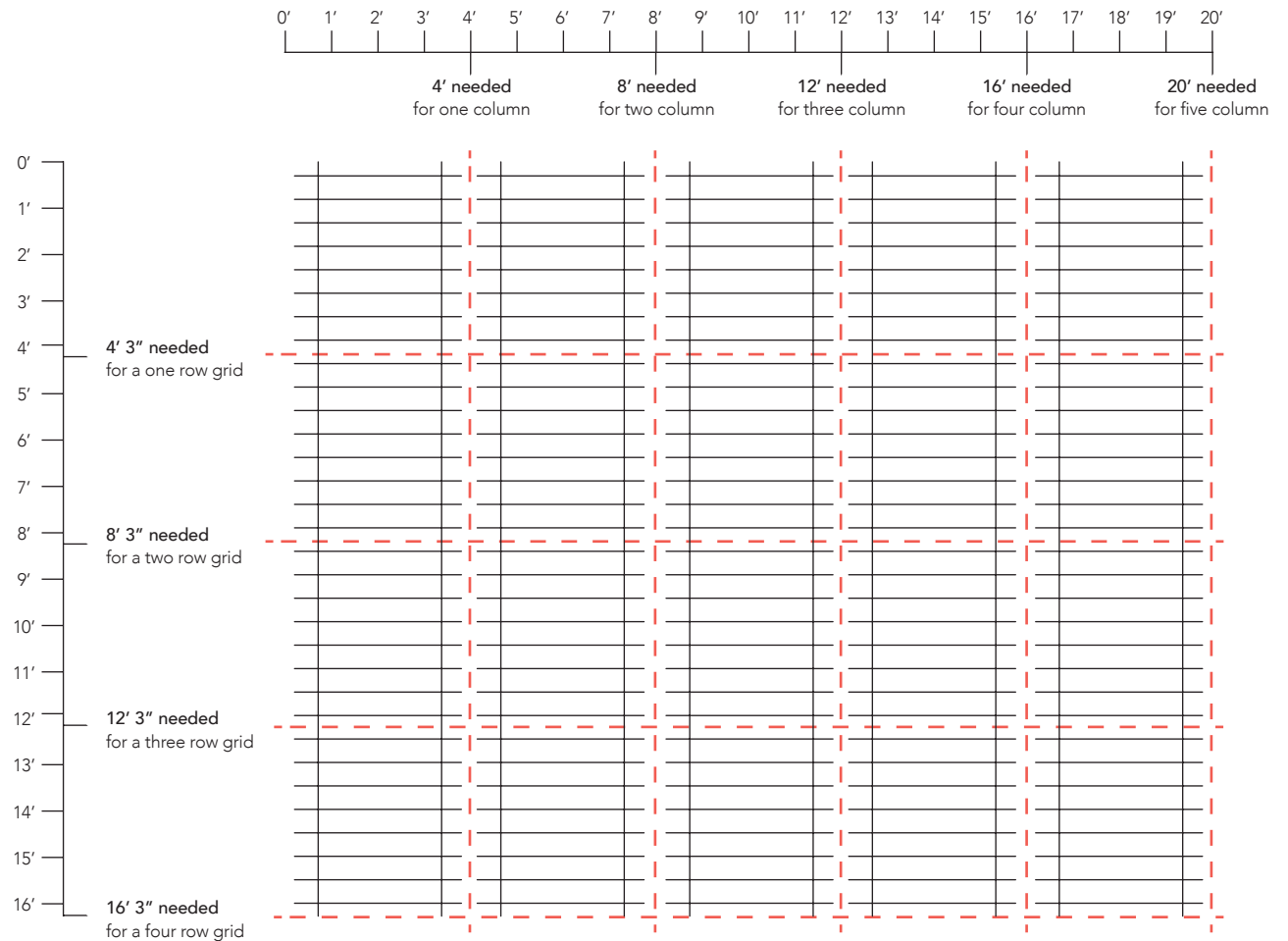

Tempo acoustic baffles

Available Designs

Tempo ceiling grids are available in 4 standard designs. All panels are priced the same, regardless of selected design.

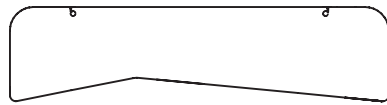

Turn 1



Turn 2

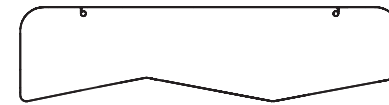

Turn 3



Tilt 1



Tilt 2

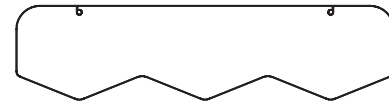

Tilt 3



Tab 1



Tab 2

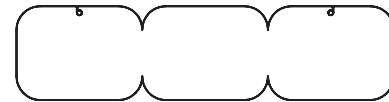

Tab 3



Tide 1



Tide 2



Tide 3

Hardware

Tempo ceiling grids are mounted with 4 ceiling couplers, 4 cables, and 2 dowel rods. Standard ceiling grids have a white ash dowel rod. For an additional cost, Aspen or Ebony dowel rods are available.

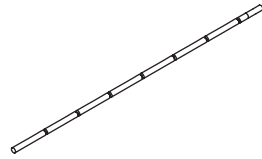

DOWEL ROD



CEILING COUPLER

Thicc acoustic baffles

Pricing

To price Thicc, select a size-based SKU and mounting method.

Typicals

Thicc is available in 3 sizes, all of which use 9mm thick PET.



BA-THC-BASE-SML

Dimensions	47.5" W x 11.75" H x 3"
Panel(s)	(1) panel
Price	\$255.00 per



BA-THC-BASE-MED

Dimensions	72" W x 11.75" H x 3"
Panel(s)	(1) panel
Price	\$385.00 per



BA-THC-BASE-LRG

Dimensions	92" W x 11.75" H x 3"
Panel(s)	(1) panel
Price	\$505.00 per

How to Price Thicc Acoustic Baffles

Below is the cost per square foot of finished ceiling coverage, based on one Thicc panel plus its on-center spacing. Select the column matching your desired spacing to see exactly what you'll pay per ft² of ceiling area.

Size	List Price	Dimensions (in)	6" Spacing (\$/sq ft)	12" Spacing (\$/sq ft)	24" Spacing (\$/sq ft)
Small	\$255.00	47.5" × 11.75"	\$76.26	\$41.14	\$19.02
Medium	\$385.00	72" × 11.75"	\$78.92	\$43.99	\$21.38
Large	\$505.00	92" × 11.75"	\$82.50	\$46.63	\$23.22

Note: "6" Spacing" means panels hung 6 inches on-center (panel thickness + 6" equals the module width). The 12" and 24" columns show how your cost per ft² decreases as panels are spaced farther apart.

Mounting

Thicc needs to be ceiling mounted with either a ceiling coupler, ceiling track or clip.

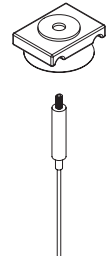
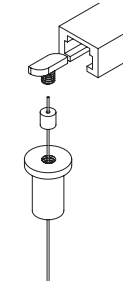
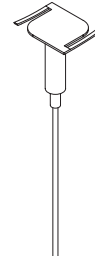

CEILING COUPLER

Price Included

T-GRID CLIP

Price \$65.00 per

TMU COUPLER & TRACK

Price \$625.00

UNISTRUT COUPLER

Price *\$190.00 per

*Unistrut tracks are not included

Panels

Thicc is available in a variety of acoustic felt finishes. For a complete list of finishes please visit loftwall.com/thicc. All panel finishes and designs are priced the same.

Name

Description

PET felt (AKUS-)

Sound-absorbing panel

Designs

Thicc has three different design options for all three of its sizes.



BASE



PITCH

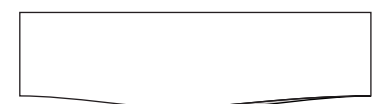

WAVE

Thin acoustic baffles

Pricing

To price Thin, select a size-based SKU and mounting method.

Typicals

Thin is available in 3 sizes, all of which use 9mm thick PET.



BA-THN-BASE-SML

Dimensions	47.5" W x 11.75" H x 1.125"
Panel(s)	(1) panel
Price	\$135.00 per



BA-THN-BASE-MED

Dimensions	72" W x 11.75" H x 1.125"
Panel(s)	(1) panel
Price	\$205.00 per



BA-THN-BASE-LRG

Dimensions	92" W x 11.75" H x 1.125"
Panel(s)	(1) panel
Price	\$270.00 per

How to Price Thin Acoustic Baffles

Below is the cost per square foot of finished ceiling coverage, based on one Thin panel plus its on-center spacing. Pick the column matching your desired spacing to see exactly what you'll pay per ft² of ceiling area.

Size	List Price	Dimensions (in)	6" Spacing (\$/sq ft)	12" Spacing (\$/sq ft)	24" Spacing (\$/sq ft)
Small	\$135.00	47.5" × 11.75"	\$51.98	\$24.89	\$10.82
Medium	\$205.00	72" × 11.75"	\$53.09	\$26.76	\$12.23
Large	\$270.00	92" × 11.75"	\$55.65	\$28.47	\$13.34

Note: "6" Spacing" means panels hung 6 inches on-center (panel thickness + 6" equals the module width). The 12" and 24" columns show how your cost per ft² decreases as panels are spaced farther apart.

Mounting

Thin needs to be ceiling mounted with either a ceiling coupler, ceiling track or clip.

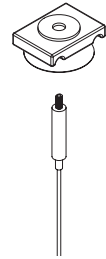
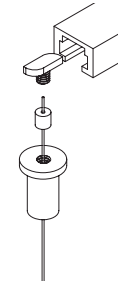
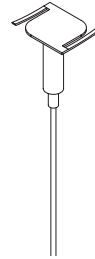

CEILING COUPLER

Price Included

T-GRID CLIP

Price \$65.00 per

TMU COUPLER & TRACK

Price \$625.00

UNISTRUT COUPLER

Price *\$190.00 per

*Unistrut tracks are not included

Panels

Thin is available in a variety of acoustic felt finishes. For a complete list of finishes please visit loftwall.com/Thin. All panel finishes and designs are priced the same.

Name	Description
PET felt (AKUS-)	Sound-absorbing panel

Designs

Thin has three different design options for all three of its sizes.

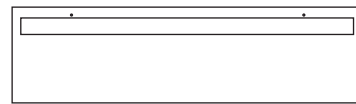

BASE

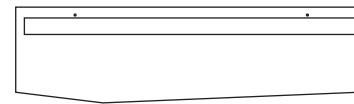

PITCH



WAVE

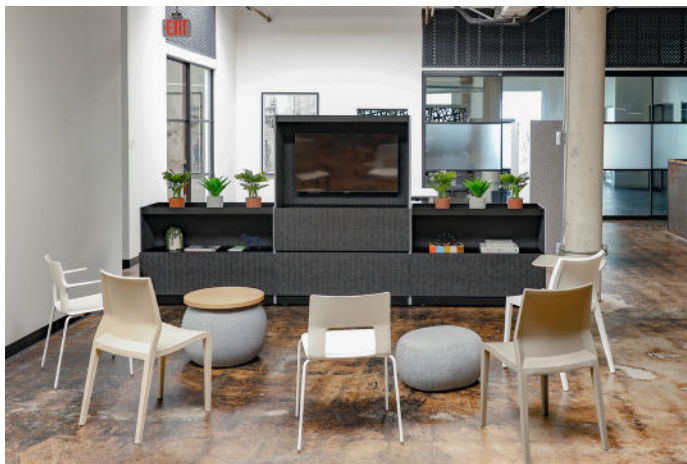

Storage Systems

Organize, define, and transform your space with Loftwall's versatile Storage Systems. This category features Hedge and Shift, two innovative solutions designed to offer flexible storage, space division, and acoustic benefits. Whether you need mobile shelving, media integration, or sound absorption, these systems provide modern solutions for dynamic work environments.

STORAGE SYSTEMS

Hedge.....	103
Shift.....	105



SCAN FOR MORE VISUAL
REFERENCES OF FEATURED
PRODUCTS

Hedge storage systems

Pricing

Hedge is available in two standard models—Low Height and Full Height—each offering flexibility, durability, and a variety of finish options. With both monotone and duotone finishes, Hedge provides a cost-effective solution for space division, storage, and acoustic control.

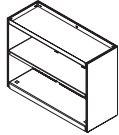
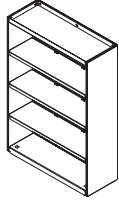
Line Drawing	Model	Dimensions (H x W x D)	Finish	SKU Format	List Price
	Low Height (LH)	34.5" x 46.5" x 17.75"	Monotone (Grade A)	HE-*shelf color*-LH-*exterior color*-*interior color*	\$2,995.00
	Low Height (LH)	34.5" x 46.5" x 17.75"	Duotone (Grade B)	HE-*shelf color*-LH-*exterior color*-*interior color*	\$3,370.00
	Full Height (FH)	67.5" x 46.5" x 17.75"	Monotone (Grade A)	HE-*shelf color*-FH-*exterior color*-*interior color*	\$4,740.00
	Full Height (FH)	67.5" x 46.5" x 17.75"	Duotone (Grade B)	HE-*shelf color*-LH-*exterior color*-*interior color*	\$5,240.00

Available Add-Ons

Expand Hedge's functionality with customizable add-ons. From magnetic doors to whiteboards and TV mounts, these accessories make Hedge more than just a divider—it becomes a complete space solution. The magnetic PET doors are available in 24 PET colors, allowing you to perfectly match or contrast with the frame finish of your choice.

Add-On	SKU	Price	Dimensions
Magnetic PET Door	HE-DOOR-color	\$600.00 per door	46.25" x 29"
Whiteboard	HE-DEM	\$705.00 per whiteboard	33" x 47"
TV Mount	HW-TV-MOUNT	\$430.00 per mount	N/A
Caster Cups	N/A	Complimentary, available upon request	N/A

PET Panels

Hedge's frame is built using high-quality, sound-absorbing PET panels available in two distinct finishes. Choose between Charcoal and Marble to create a functional yet stylish workspace. These finishes not only enhance the look of your office but also provide acoustic benefits, making Hedge an effective solution for noise reduction and space division.

Name	Description
PET felt (AKUS-)	Sound-absorbing panel

Shelf Finish & Colors

Hedge's shelves are powder-coated for durability and style, available in two versatile finishes. With options in White and Black, these shelves complement the PET panel finishes and ensure a cohesive, sleek look for any workspace.

Name	Description
Powder Coat White, and Powder Coat Black	Durable, powder-coated steel shelves

Shelf Doors Colors

While Hedge's frame is limited to Marble and Charcoal finishes, the magnetic PET doors offer full flexibility with 24 color options. This allows you to create a striking contrast or seamless coordination with your workspace design. Whether you choose a subtle tone or a bold accent, the doors offer a wide range of colors to complement your space while maintaining Hedge's functional versatility.

Name	Description
PET felt (AKUS-)	Sound-absorbing panel

Bases

Hedge's base option includes rolling casters for mobility. Keep your space flexible with Hedge's caster base, ideal for creating dynamic layouts.



HE-CASTER

60mm

Price	<i>Included</i>
-------	-----------------

Shift storage systems

Pricing

To price Shift, select a size-based SKU and add the price of any panel inserts. There is no price difference for shelf or frame finishes.

Typicals

Shift is available in 4 unique size-based styles. Shift is available in 3 shelf finishes noted as -XX- in the product SKU.

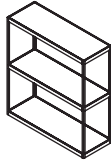
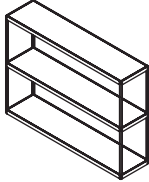
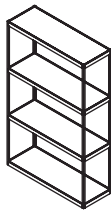
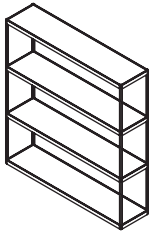
	4' WIDE	6' WIDE											
53" TALL													
	SH-XX-LH-4	SH-XX-LH-6											
	<table border="1"> <tr> <td>Dimensions</td> <td>4' W x 53" H x 17.25" D</td> </tr> <tr> <td>Description</td> <td>4' Wide, Low Height</td> </tr> <tr> <td>Price</td> <td>\$3,395.00</td> </tr> </table>	Dimensions	4' W x 53" H x 17.25" D	Description	4' Wide, Low Height	Price	\$3,395.00	<table border="1"> <tr> <td>Dimensions</td> <td>6' W x 53" H x 17.25" D</td> </tr> <tr> <td>Description</td> <td>6' Wide, Low Height</td> </tr> <tr> <td>Price</td> <td>\$4,755.00</td> </tr> </table>	Dimensions	6' W x 53" H x 17.25" D	Description	6' Wide, Low Height	Price
Dimensions	4' W x 53" H x 17.25" D												
Description	4' Wide, Low Height												
Price	\$3,395.00												
Dimensions	6' W x 53" H x 17.25" D												
Description	6' Wide, Low Height												
Price	\$4,755.00												
78" TALL													
	SH-XX-FH-4	SH-XX-FH-6											
	<table border="1"> <tr> <td>Dimensions</td> <td>4' W x 78" H x 17.25" D</td> </tr> <tr> <td>Description</td> <td>4' Wide, Full Height</td> </tr> <tr> <td>Price</td> <td>\$4,080.00</td> </tr> </table>	Dimensions	4' W x 78" H x 17.25" D	Description	4' Wide, Full Height	Price	\$4,080.00	<table border="1"> <tr> <td>Dimensions</td> <td>6' W x 78" H x 17.25" D</td> </tr> <tr> <td>Description</td> <td>6' Wide, Full Height</td> </tr> <tr> <td>Price</td> <td>\$5,440.00</td> </tr> </table>	Dimensions	6' W x 78" H x 17.25" D	Description	6' Wide, Full Height	Price
Dimensions	4' W x 78" H x 17.25" D												
Description	4' Wide, Full Height												
Price	\$4,080.00												
Dimensions	6' W x 78" H x 17.25" D												
Description	6' Wide, Full Height												
Price	\$5,440.00												

Panels

Shift can be outfitted with a variety of infill panels. While not necessary, these panels elevate the design and function of Shift. Small panels are 2'x2' while large panels are 2'x4'. Note: panel SKUs are identified *finish*-*size*-*color*.

Level	Name	Description	2x2	2x3	2x4
1	PET felt (AKUS-)	Sound-absorbing panel	\$85.00	\$125.00	\$170.00
1	Twinwall Polycarbonate (TW-)	Translucent panel	\$85.00	\$125.00	\$170.00
2	Frosted or Clear Acrylic (AC-)	Translucent panel	\$145.00	\$210.00	\$280.00
2	Nonmagnetic Dry Erase (DEP-)	White dry erase surface	\$145.00	\$210.00	\$280.00
2	Cutout Composite Panel (PEG-) (WEB-)	Pegboard & Web	\$145.00	\$210.00	\$280.00
2	Laminates (SC-)	Woodgrain and solid finishes	\$145.00	\$210.00	\$280.00
2	Chisel (*PATTERN*-AKUS-)	Acoustic knife cut design panels	\$145.00	\$210.00	\$280.00
3	Magnetic Dry Erase (DEM-)	White dry erase surface	\$415.00	\$620.00	\$820.00
3	Blox Panel (BLX-)	Up to 85% sound absorption	\$480.00	N/A	\$945.00
3	Custom Artwork Panel	Custom branded panels	quote	quote	quote
3	Custom Material Panel	3Form, Lumicor, Wilsonart	quote	quote	quote

Frame Colors

Shift are available in 3 standard frame finishes. All standard frame finishes are priced the same. Custom colors may be available upon request.

Name	Description
Silver, White, and Black	Price included in product.
Custom Colors and Finishes	Contact us for a quote!

LOFTWALL